

TEKST NR 93

1985

The Semiotics of
Quantum-Non-Locality

Peder Voetmann Christiansen

TEKSTER fra

IMFUFA

ROSKILDE UNIVERSITETSCENTER
INSTITUT FOR STUDIET AF MATEMATIK OG FYSIK SAMT DERES
FUNKTIONER I UNDERVISNING, FORSKNING OG ANVENDELSER

IMFUFA, Roskilde Universitetscenter, Postbox 260, 4000 Roskilde

THE SEMIOTICS OF QUANTUM-NON-LOCALITY

af Peder Voetmann Christiansen

IMFUFA tekst nr. 93/85 RUC.

60 sider.

ISSN 0106-6242

ABSTRACT

The paradox of Einstein, Podolski and Rosen was evoked to point out the incompleteness of quantum mechanics. The idea was that the predictions of quantum mechanics could not be trusted in cases where it contradicted the principle of local realism. This principle has normally been considered closely connected to theories of local hidden variables, although this connection is not drawn in the Einstein, Podolski, Rosen paper. It is argued in the present paper that recent experiments by Aspect and others, although they have confirmed quantum mechanics and disproven local hidden variables through the application of Bell's inequalities, have neither disproved the incompleteness of quantum mechanics nor the general principle of local realism. By applying the principle of synechism with the methods of semiotics invented by the american philosopher C. S. Peirce it is shown that it is possible to define "local realism" by continuity of interaction such that quantum mechanics itself is local realistic without hidden variables. As a consequence of this viewpoint it is shown that the validity of the quantum formalism in cases where it contradicts Bell's inequalities will depend on the connectedness, through coincidence counters or similar devices, of the experimental device. It is suggested that an experiment like the first of Aspect's but without these connections will lead to results in accordance with Bell's inequalities.

THE SEMIOTICS OF QUANTUM-NON-LOCALITY.

Peder Voetmann Christiansen.

Institute of Mathematics and Physics and their function in
Education, Research, and Application.

Roskilde University Center

P.O. box 260, DK 4000, Roskilde, Denmark.

PACS: 03.65.Bz

CONTENTS

1. The completeness of quantum theory.	1
2. Local realism and connectedness.	3
3. Causal logic of the quantum collapse.	6
4. Categories and triadic relations.	11
5. Zero point noise as a sign of consistency.	20
6. The qualitative jump.	24
7. The concept of connectedness.	35
8. The return to reality.	44
APPENDIX: Simulation of discrete noise.	52
Notes and references.	57

1. The completeness of quantum theory.

The philosophical debate concerning the Einstein-Podolski-Rosen (EPR) paradox ^{1.} has reached a new climax recently. Based on Bell's operational conception of Einstein-locality ^{2.} several successful experiments have vindicated quantum mechanics ^{3.} Most convincingly the series of experiments performed by Aspect and coworkers have demonstrated the validity of the quantum mechanical formalism ^{4.}

Still, the original question posed by Einstein, Podolsky and Rosen "Can Quantum Mechanical Description of Physical Reality be Considered Complete?" remains unanswered. The question of completeness regarded experimentally can only give a clear answer by contradicting quantum mechanics, an experimental affirmation can never with certainty lead to the conclusion that quantum mechanics is complete. The belief in the completeness of the theory as expressed by Niels Bohr ^{5.} seems to be widespread in the physical community, to a degree such that many would deny that an alternative outcome of Aspect's experiments is thinkable and that such experiments therefore are of only slight interest.

Because completeness cannot be proven experimentally, belief in it can only be maintained by pure conviction, or on logical grounds. A logical proof of completeness for a physical theory like quantum mechanics would probably be more difficult to establish than a completeness proof for a mathematical theory, say the theory of whole numbers, for two reasons: First, the mathematical theory is a part of the physical theory, and, second, the semantical questions of interpretation of the physical symbols are much more intricate than the interpretation of mathematical symbols. A formalism cannot prove itself with formulae alone, and questions of consistency and completeness are meaningless unless an interpretation is provided so one cannot escape from problems of semantics or semiotics. In mathematics and formal logic an interpretation is normally considered as context-free and formally treated like a mapping of the symbols of the language onto the objects in a domain under investigation ^{6.} In physics, however, and especially in quantum mechanics, an interpretation is highly dependent on the context of measurement and does really not exist without this context. This important semantic thesis of quantum mechanics was stressed by Bohr in his answer to EPR ^{5.}:

"There can be no question of any unambiguous interpretation of the symbols of quantum mechanics other than that embodied in the well-known rules which allow to predict the results to be obtained by a given experimental arrangement described in a totally classical way."

Although Bohr claimed to have refuted the EPR conception of incompleteness, it looks as if the above quotation indirectly points to another sign of incompleteness. If the meaning of the wave function can only be grasped on the basis of a classical description of a measuring apparatus then it is presupposed that sufficiently ideal measuring equipment can be designed and built, but it is dubious if quantum mechanics proper can give us an exact description of the demands to be met by a measuring apparatus in order for it to be "sufficiently ideal". After all, it is thinkable that an experimental physicist who is convinced of the validity of quantum mechanics could perform an experiment with a result in disagreement with the formalism. Such an experiment could not be used as a reference for defining the meaning of the wave function because, presumably, something is wrong with the apparatus, and, according to Bohr, it should be possible to define "in a totally classical way" exactly what the error is. Bohr's definition of the meaning of the wave function points to the existence of a conceptual discontinuity, a "cut" associated with the physical location of an "interface" beyond which a quantum description is meaningless, and this of course would mean that quantum mechanics is incomplete, although in another sense than that implied by the EPR argument. An orthodox Copenhagen interpretation would hesitate before the acceptance of such an incompleteness by appealing to the correspondence principle and the belief expressed by Bohr that the "cut" or "interface" could be pushed arbitrarily long inside the apparatus towards the classical degrees of freedom. The validity of this assumption, however, is rather dubious due to the difficulties encountered in the quantum description of irreversible processes which necessarily must be of prime importance in a measuring/amplifying device, so a theoretical proof of completeness along these lines is bound to run into insurmountable obstacles.

The EPR paper was published in 1935 shortly after Gödel's proof (1931) of the incompleteness of mathematical formal systems including Peano's axioms of whole numbers. Gödel had shown that neither consistency nor completeness could be proven formally, but that consistency implied incompleteness. Probably Einstein conceived a parallel situation with respect to quantum mechanics although he did not refer to Gödel's proof. After his discussions with Bohr at the Solvay-meetings 1927-30 he seems to have been convinced that quantum mechanics at least was consistent in the sense that it could describe a limited part of the physical reality without leading to contradictions. It would then seem natural to look for signs of incompleteness and this should not be regarded as a rejection of the formalism. However, in Copenhagen the shift in Einstein's attitude seems to have been unnoticed, and the EPR-paper was considered as just another new attack on quantum mechanics ⁷.

While the fate of incompleteness is acceptable, inconsistency, of course, would be disastrous. It is a common misunderstanding that the EPR paradox is intended to point out an inconsistency in quantum mechanics, so it is important to stress that the logic of the paper only points to incompleteness by evoking a paradox that arises as a consequence, not of the formalism per se, but from the metaphysical belief in the universal validity of the formalism even in cases where it contradicts the principle of local realism, or Einstein separability. The philosophical question remaining is therefore if the Aspect experiments can be claimed to have disproven the notion of local realism that permeates the EPR paper.

2. Local realism and connectedness.

Due to the analyses by Bell and their follow up by Clauser, Horne, Shimony, Aspect and others it seems tempting to conclude that theories based on objectively local hidden variables have been disproved, although some small loopholes exist and several authors maintain their scepticism⁸. If local realism was synonymous with local hidden variables there would be sufficient reason to cling to these loopholes, but there is a difference, and it is a main purpose of this paper to point out that quantum mechanics can be locally realistic without hidden variables and without strange effects associated with the loopholes. To the opinion of the author an experiment in the spirit of EPR is possible and may falsify local realism, but it has not been performed yet.

There is a strange discrepancy between the way experiments like Aspect's are described in theoretical reviews and the way it is performed in reality. In theory one measures the correlation in polarization of two photons emitted in a cascade by performing two independent polarization measurements on the individual photons. For example, Mermin in his popular description⁹ emphasizes the importance of the disconnectedness of the two individual detectors:

"there are neither mechanical connections (e.g. pipes, rods, strings, or wires) nor electromagnetic connections (e.g. radio, radar, or light signals) nor any other known relevant connections. Irrelevant connections may be hard to avoid. For example, all three parts may sit on the same table top."

For a naive consideration it is difficult to reconcile Mermin's remark with the circuit diagrams or photos of actual experimental setups from Freedman and Clauser to Aspect and coworkers. All these pictures show clearly that the two distant sets of single-particle detectors are well connected with solid wires to some "central black boxes", like coincidence counters and/or time-to-amplitude converters. Apparently, there must exist a tacit agreement that these connections are to be considered "irrelevant" in spite of the crucial role they play in the experiments.

This common agreement can only be justified by reference to the processes of amplification in the electronic devices, which according to classical causal logic ensures that signals are propagated easily from the single-particle detectors to the central black boxes, but not the other way, at least not to a degree such that correlated signals propagating the other way could have any significant effect on the quantum expectations.

The question is: is the justification given above for the irrelevance of these connections well enough founded in a quantum mechanical context? Isn't it just in denying the possibility of a pure one-way communication that quantum mechanics distinguishes itself most significantly from classical mechanics? As Bohr put it in his EPR-reply ⁵ :

"The finite interaction between the object and measuring agencies conditioned by the very existence of the quantum of action entails - because of the impossibility of controlling the reaction of the object on the measuring instruments if these are to serve their purpose - the necessity of a final renunciation of the classical ideal of causality and a radical revision of our attitude towards the the problem of physical reality."

This was the viewpoint that proved itself successful in the Solvay discussions between Bohr and Einstein (1927-30) on the consistency of quantum mechanics. In his reply to EPR, however, Bohr mixes it with a more "idealistic" or logical argument in a rather confusing manner. After having mentioned the EPR problem whether a measurement of the state of "particle 1" can be said to immediately determine the state of "particle 2" he writes:

"of course there is in a case like that just considered no question of a mechanical disturbance of the system under investigation during the last critical stage of the measurement procedure. But even at this stage there is essentially the question of an influence on the very conditions which define the possible types of predictions regarding the future behavior of the system."

It is not entirely clear what the connection is between the "finite interaction" in the first quotation and the "very conditions" in the second. When we make a measurement on particle 1 we have a free choice of measuring one or the other of two complementary properties of particle 1, e.g. position or momentum. The choice between the two different ways of interaction with particle 1 according to Bohr prohibits the use of the EPR-term "the same reality" for particle 2 even though this particle is not affected by any mechanical disturbance, and this is because quantum mechanics forces us to regard the whole phenomenon of preparation and measurement as possessing an "individuality completely foreign to classical physics". The "very conditions" in the second quotation thus seems to be the formalism of quantum mechanics associated with the philosophy of complementarity, and Bohr is trying to

persuade the reader to accept that quantum mechanics defines how the term "physical reality" may be correctly used. This is of course difficult to accept from a realistic standpoint: when the question is whether the quantum mechanical description of physical reality is complete then the answer that quantum mechanics itself defines what "physical reality" is looks like a philosophical shortcircuit or cheating in the game of debate.

Apart from breaking with realism the introduction of the "very conditions" also manages to break with the locality principle in a subtle way. When we measure one or the other of the two complementary properties of particle 1 without disturbing particle 2 then it is true that quantum mechanics gives an unambiguous prediction for the future behavior of particle 2, viz. a wave function corresponding to a pure state of that particle. The "finite interaction" is in this case only involving particle 1, but it produces via the "very conditions" a change of state of particle 2. Bohr seems to forget that we still have the possibility of making an independent measurement on particle 2 and that this would amount to a test of the formalism that can be performed whether one accepts the influence via the "very conditions" or not. What about the "finite interaction" with particle 2 that would be introduced by such a second measurement? Can we be sure that it doesn't produce a conflict with the "very conditions" if there are no physical connections between the two measurements? These questions are unanswered in Bohr's article and according to the orthodox Copenhagen interpretation of quantum mechanics one is really not allowed to ask such questions. Now that experiments have been performed of which the majority confirm quantum mechanics there is a danger that such a prohibition will be enforced to prevent a closer theoretical study of the measurement situations and the semantics of quantum theory.

It is tempting to compare Bohr's two conflicting (?) points of view, the physical and the logical, from the standpoint of the so called synechistic philosophy created by the great american thinker C. S. Peirce (1839 - 1914) ¹⁰. The synechism of Peirce is based on semiotics, the logic of signs and relations, and on the belief that our symbolic concepts in the physics are connected with other signs in a psycho-physical continuum ^{10c}. Ideas interact with matter by close contact, says Peirce, and in particular, the process of measurement establishes the point of contact between the symbolic signs of physics and the indexical signs of nature. Undoubtedly Peirce, if he had had the possibility of studying the Einstein - Bohr discussion, would have supported Bohr's physical viewpoint (as well as his thesis that God plays dice), but he would probably not support Bohr's logical viewpoint in the last

quotation, because it tries to circumvent a synechistic explanation.

There is also another point in the last Bohr-quotation that disagrees with Peirce's general philosophy. The "very conditions" Bohr speaks about are formulated by quantum mechanics, so the argument bites itself in the tail and tries to persuade the reader to believe that quantum mechanics is complete, almost by definition. According to Peirce (and later, Karl Popper) the best criterion for the genuine scientific status of a theory is its "fallibility" i.e. its ability to put its ideas to a crucial test that conceivably might falsify the theory.

The synechistic philosophy of Peirce is very general definition of local realism. By combining it with relativistic ideas of the absence of "action at a distance" and the finite limiting velocity of signal propagating it is further sharpened to encompass the notion of Einstein separability. There is no conflict between synechism and modern quantum field theory because the latter is built upon the synechistic principle of local interactions. The integrity of Peirce's philosophy is exhibited by the observation that EPR experiments can be regarded as falsification tests of synechism. If the Aspect experiments can be said to have falsified synechism it is of course on a very isolated point having to do with the ill understood process of quantum collapse but with no direct consequence for the wave equations, but still, the consequences of such a falsification would be serious because it would undermine the locality principle of quantum field theory and open up for wild speculations apparently with no connections to the main body of physics.

However, the lack of connectedness in the ideal EPR experiment and the strong connectedness in the real experiments pointed out above leads to the idea that a synechism-falsifying experiment has not yet been performed. A synechistic explanation of the quantum mechanical correlations observed in the Aspect experiments based on the connectedness of the experimental equipment would be in the spirit of Peirce's (and also in the earlier spirit of Bohr's). Also, it would indicate directly how the crucial experiment could be performed, e.g. by literal implementation of Mermin's remark on the absence of connections.

3. Causal logic of the quantum collapse.

The abrupt changes described as quantum jumps has since Bohr's early theory of the hydrogen atom been a major obstacle to the visualization of quantum mechanical concepts, alien as it is to our intuitive notion of con-

tinuity expressed in Leibniz' thesis Natura non facit saltus. Bohr was painfully aware of the difficulty but insisted that it has no meaning to think of an electron in a state during the jump in between stationary states. Later developments softened this view but the irreducible quantum jump survived in the process described as the collapse or the reduction of the wave function in connection with measurements.

A philosophical "explanation" of the collapse as a transition from potentiality to reality is easy to formulate but difficult to be satisfied with in the long run, because of the lack of clarity of these two philosophical terms. The striking success of using the concept of a wave function to explain phenomena like superfluidity and other macroscopic effects has shown the wave function as much more real than a mere potentiality or a way of expressing our predictions for hypothetical measurements. The problem is that mutually exclusive or complementary "potentialities" have ways of expressing themselves as "real" in other ways than by proper measurements (one of the main points of the EPR paper). If one can perform a measurement in one point of space and thereby specify which potential property is realized in another point without physical connections to this other point then it is difficult to avoid thinking that the potentialities are somehow real before the measurement. On the other hand it leads to contradictions if one tries to erase the distinction between wave functions and probabilities as shown by v. Neumann. It is as if the wave function in an uncanny way knows in advance which of its latent possibilities will be realized by an experiment, and this has led to many strange ad hoc theories of "backward causality" or "splitting universes".

As stressed by Bohr the classical notion of causality must be abandoned when we discuss the quantum mechanical measurement process. The classical idea of cause-effect relationship is based on the assumption that signal variables exist, having definite numerical values independent of our measurements. This assumption was already heavily criticized by Peirce in 1892 in "The Doctrine of Necessity Examined" ^{10b.}. Peirce's viewpoint is that the meaning of a symbol like a number on a continuous scale, with uncertainty inherent, exists only in the context of a measurement and a statistical procedure. Therefore, we ought to drop the idea that exact numerical values of continuous quantities exist by themselves in nature as well as the idea of exact (classical) causality, and we must allow God the freedom to play dice:

"Those observations which are generally adduced in favor of mechanical causation simply prove that there is an element of regularity in nature, and have no bearing whatever upon the question of whether such regularity is exact and universal, or not. Nay, in regard to

this exactitude, all observation is directly opposed to it; and the most that can be said is that a good deal of this observation can be explained away. Try to verify any law of nature, and you will find that the more precise your observations, the more certain they will be to show irregular departures from the law. We are accustomed to ascribe these, and I do not say wrongly, to errors of observation; yet we cannot usually account for such errors in any antecedently probable way. Trace their causes back far enough, and you will be forced to admit they are always due to arbitrary determination, or chance." ^{10b.}

Bohr emphasized that it is the finite interaction between the object and the measuring agencies that necessitates a break with classical causality, and in doing this he revitalized ideas that Peirce had formulated more than 40 years earlier; ideas that in Peirce's time were too revolutionary to be recognized as more than crackpot philosophy and had been almost completely forgotten in the meantime.

Bohr, in his philosophy of complementarity and especially in his doctrine of the irreducible quantum jump and the breakdown of classical causality, was probably inspired, if not directly influenced, by the Danish existentialist religious philosopher Søren Kierkegaard who around the middle of the 19th century made some highly original contributions to the logic of concepts in theology and psychology. Kierkegaard had an important inspiration in common with Peirce: a fascination of Hegel's dialectical philosophy that later resulted in a thoroughly antagonistic attitude towards it. In several books Kierkegaard emphasizes the freedom of choice as a "qualitative jump" that cannot be analyzed by linear causal reasoning. There is no question of any Hegelian or Marxian turnover of quantity into quality. In "The Concept of Dread" (1844) he describes the need and the difficulty of another type of bootstrapping circular causality in connection with the jump:

"This jump is furthermore setting the quality, but when the quality is set in the same moment the jump turns into the quality and is preset by the quality. This is an offence to our reason, ergo it is a myth. Accordingly reason itself invents a myth denying the jump and laying out the circle in a straight line, whereby everything proceeds naturally."

In pointing out a possible influence from Kierkegaard to Bohr ^{11.} the author is well aware that professional philosophers have denied the existence of such a relation ^{11a.}. Also, that Bohr in his later years had a sceptical attitude towards the entire subject of philosophy. The dominating positivistic philosophy in the 20th century seems to have encouraged the attitude that physical science was shaped by the observation of the facts in nature and not by philosophy. However, Bohr's philosophy of complementarity was made in his younger years when he was not so sceptical and, according to many

witnesses, even before the crucial empirical facts of quantum physics were established. On a non-positivistic background as Peircean semiotics or Kierkegaard's conceptual logic it seems not so strange that our language exhibits relational invariances over different subjects and that a psychological problem may have something in common with the "very conditions" for making statements in physics.

Especially after the Aspect experiments it has become generally accepted that the "Copenhagen interpretation" of quantum mechanics stand successfully and unrefuted against its competitors. However, what one calls "the Copenhagen interpretation" is nowadays often confused with a dogmatic faith in the universal validity (completeness) of the formalism and unwillingness to discuss the semantics of alternative interpretations of the wave function. Although, undoubtedly, Bohr in his answer to EPR has contributed to this misinterpretation, it is clearly against his earlier philosophy of complementarity. This epistemology which more than formalism is centered in Copenhagen has never really made its impact on main-stream physics outside this city. Copenhagen in the 19th century was more like a village where everybody knew each other and made far reaching cross-disciplinary ventures uniting the arts with science and philosophy. This is the essence of the "Copenhagen schools" that have emerged in psychology (Rubin), linguistics (Brøndal, Hjelmslev), and physics (Bohr) ^{11b.}, but of course it cannot easily be translated to the international community.

The early success of the Copenhagen school in quantum physics was due to a fruitful mergeance of philosophical ideas resulting in a mathematical formalism. Later, it seems unfortunately, that its proponents (e.g. J. A. Wheeler) have decided to believe in the universal validity of the formalism and extrapolate it ad absurdum in order to dictate a philosophy. The opposite trend, a return to epistemology and a semantic effort to understand the meaning and the limitation of the formalism (e.g. Bell, d'Espagnat, Shimony) is still going on but has found its major inspiration in ideas from outside the circle of Copenhagen, e.g. in Bohm's continuing search for hidden variables. This latter trend has been the driving theoretical force behind the experiments, and it would be a sad fate if the experimental results should drain the energy from it and further a formalistic petrification in the name of Copenhagen.

It is the impression of the present author that the means of formalistic expression are still as inadequate as ever to deal with ideas like Kierkegaard's of the qualitative jump and Bohr's concept of complementarity. The

only way to go is back to natural language and forward again with a new and more adequate formalism based on the parts of conceptual logic that have been overlooked and suffocated by the present formalism.

A symptom of the present state of affairs is the way the word "interaction" is used in physical textbooks and journals. A discussion of "interaction" is nowadays considered synonymous with the formalistic task of choosing the suitable Lagrangian or Hamiltonian function. This is rather contrary to the meaning of the word, for in cases where the influence from the environment (the laboratory) on the quantum mechanical system can be described with a Hamiltonian it is presupposed that what Bohr calls "the reaction of the object on the measuring instruments" can be neglected, i.e. there is no interaction but only action of classical fields.

A formalism that operates only with equations of symbolic expressions can never really penetrate behind the idea of classical mechanic causation, so any attempt to solve the measurement problem of quantum mechanics by proposing a new set of equations, perhaps based on fancy Hamiltonians, are doomed from beginning. Kierkegaard and Peirce were aware of the conceptual logic leading to this conclusion long before the dawn of the new physics. For Kierkegaard it resulted in a rather hostile attitude towards all formal systems, whereas Peirce from about 1880 to his death in 1914 was engaged in a grand attempt to formalize his ideas in the framework of relational logic and semiotics. Peirce did never complete his great system (just like Archimedes who never completed physics) and important parts of it are probably still buried in his vast heaps of papers awaiting publication hopefully within the next 10 or 20 years.

The fragments of Peirce's system that have been published have already proved its applicability. One of the most interesting applications in physics of semiotic and synechistic ideas was described by H. M. Paynter in 1961¹². Paynter's formalism is based on the primitive notion of energy bonds or interaction-bonds. Physical systems are described with bond graphs exhibiting their structure of interaction relations and very similar to the bond graphs used by Peirce for analysis of the relational logic of sentences in natural language. The bond graph notation of physics has mostly been applied to problems in engineering and biophysics, i.e. in classical situations where an interaction bond can be translated to two oppositely directed signals whose product is the rate of energy transfer from one conceptual lump of the system to another. However, the basic philosophy of interaction bond graphs is that the concept of interaction is more fundamental than signals and classical causation. We can use bond graphs classically to derive equations of motion,

e.g. Hamiltonian, thermodynamic, hydrodynamic equations, or the Schrödinger equation, i.e. all sorts of well known physical equations, but more important, they give us a means of expression behind equations to be used in situations where a translation to equations would miss the point.

4. Categories and triadic relations.

A basic element in Peirce's philosophy is his doctrine of three fundamental categories: firstness, secondness, and thirdness. The following quotation is from his paper "The Architecture of Theories" (1891) ^{10a.} :

"Among the many principles of Logic which find their application in Philosophy, I can here only mention one. Three conceptions are perpetually turning up at every point in every theory of logic, and in the most rounded systems they occur in connection with one another. They are conceptions so very broad and consequently indefinite that they are hard to seize and may be easily overlooked. I call them the conceptions of First, Second, Third. First is the conception of being or existing independent of anything else. Second is the conception of being relative to, the conception of reaction with, something else. Third is the concept of mediation, whereby a first and an second are brought into relation".

The aim of Peirce in this paper is to demonstrate that philosophical systems cannot start from scratch and be safely built on "happy thoughts which have accidentally occurred to their authors". On the contrary, the philosopher who wishes to build an enduring structure

"should take note of all the valuable ideas in each branch of science, should observe in just what respect each has been successful and where it has failed, in order that in the light of the thorough acquaintance so attained of the available materials for a philosophical theory and of the nature and strength of each, he may proceed to the study of what the problem of philosophy consists in, and of the proper way of solving it."

Of course the idea of the three fundamental categories is one of Peirce's own "happy thoughts", but he considers it important to show how they crop up in various philosophical systems and sciences. As a very well known example one could take Fichte's dialectical formula:

1. Thesis. 2. Antithesis. 3. Synthesis.

Or we could take an example from Chinese philosophy:

1. Yang, the creative. 2. Yin, the receptive. 3. Tao, the way, with the well known symbol that was adopted by Bohr as his heraldic sign together with the motto: *Contraria sunt complementa*. Other examples, given by Peirce are:

"In psychology Feeling is First, Sense of reaction Second, General conception Third, or mediation. In biology, the idea of arbitrary sporting is First, heredity is Second, the process whereby the ac-

cidental characters become fixed is Third. Chance is First, Law is Second, the tendency to take habits is Third. Mind is First, Matter is Second, Evolution is Third."

It should be clear from these examples that Peirce uses his three categories ontologically to clarify the essential nature of concepts which he considers as parts of reality. However, his point of origin is not ontology but rather epistemology and the analyses of structures in language and relations of signs. Ideas of ontology cannot be proven logically but are chosen and the best choice is one that acknowledges as real the concepts that are indispensable in the logical, epistemological analysis. The resulting ontology for Peirce is therefore an objectively idealistic realism in sharp contrast with the nominalism that has dominated anglo-saxon empirical philosophy and positivism.

The three categories of Peirce's ontology are direct descendants from his early discovery in the logic of relatives: the fundamental importance of the triadic relations, i.e. relations between three different signs. Earlier logic suffered from the illusion that semantics could be reduced to dyadic relations of two signs, such as a word pointing directly to its object, and accordingly, following Aristoteles, it was mostly occupied with the study of subject-predicate sentences like "the apple is red" and in one-dimensional logical chains that could be classified in a finite family of syllogisms. An important member of this family is the syllogism known as Barbara:

all A is B
all B is C
ergo: all A is C

In the beginning Peirce believed in Barbara as the most important element of reasoning, and his analyses of how other family members could be reduced to Barbara is an important step towards the theory of mathematical quantification which he developed independent of G. Frege. Soon, however, inspired by his friend de Morgan, he realized the limitations of one-dimensional reasoning based on dyadic relations and began to visualize logical and linguistic structures as networks in more than one dimension.

The crucial insight that the triadic relation is fundamental can be formulated as a theorem of discrete topology (analysis situ). A network (a linear graph) where every node has only two incident branches is one-dimensional, i.e. in higher dimensional networks some nodes must have at least three branches. If we consider an electrical network in more than one dimension it can always be deformed to an equivalent structure where every node has at most three branches, and in the dual representations we can similarly

reduce the structure such that no mesh has more than three branches. The mathematical description of the topology of an electric network thus reduces to one triadic relation: addition with two operands and one resultant by the application of Kirchhoff's current law (for the nodes) and Kirchhoff's voltage law (for the meshes).

In the more complex case of sentences of natural language we must hunt for genuine triadic relations that cannot be reduced to dyadic relations, says Peirce, and if we encounter relations of more than three signs (words, concepts) then it must be possible to reduce these to triadic relations and thus rewrite the sentence such that the transformed sentence has exactly the same meaning as the original one. This he then demonstrated with examples using the technique of bond graphs.

The most general type of a genuine triadic relation is an asymmetric one such that each of its constituent signs play a special role determined by its place in the relation. In bond graph notation we can depict such a relation as an asymmetric node resembling an idealized concept of an electronic device with three ports: 1. input, 2. output, 3. control. The signs entering the relation are depicted as lines, the bonds, entering the ports:

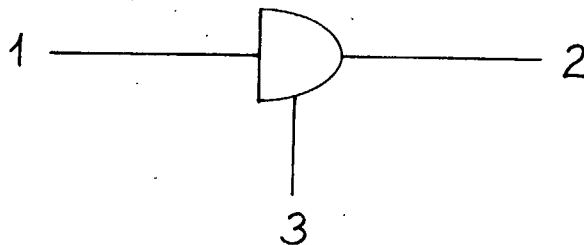

Fig. 1 Bond graph representation of triadic relation.

In this way we also represent the proper relational logic meaning of Peirce's three fundamental categories 1, 2, 3 as "ontologization" of the triadic relation. His idea is that this structure is basic to everything we can speak about and perceive as real, and it is the same structure that applies whether we analyze the most trivial model sentences such as "John gives John to John" or we speak of the highest concepts in theology such as the trinity of christianity.

All relations are relations between signs, hence the close connection between the logic of relatives and semiotics, the theory of signs. But what is then a sign? Peirce says that a sign is something that refers to an object in the general context governed by an interpretant. When we speak of a sign

and its meaning we are thus referring to a genuine triadic asymmetric relation, the sign relation, and this is the proto-type of relation of which all other relations are but more or less degenerate copies. Thus we are led into a definitorial circle of signs and relations (as for example when we speak of parts and wholes). It is the same proto-type of relation that defines the three categories, so Peirce can define "a sign" by referring to the categories in the following infamous quotation that probably has scared many away from a closer study of semiotics:

"A sign, or Representamen, is a First which stands in such a genuine triadic relation to a Second, called its Object, as to be capable of determining a Third, called its Interpretant, to assume the same triadic relation to its Object in which it stands itself to the same Object."

One of the same things Peirce manages to say with these few words is that the interpretant itself is a sign referring to the same object as the primary sign. The strange haunting quality of the formulation above is due to the words "same" and "itself" pointing to a reflexive property of the interpretant. The interpretant must in fact contain a notion of itself as a sign that refers to the same object as the primary sign. The property of reflexivity is very important in Peirce's definitions and he would never have subscribed to Russell's and Whitehead's typology of languages and meta-languages where reflexive sentences are forbidden in order to avoid paradoxes.

The sign relation being a genuine triadic relation can degenerate in three ways towards (almost) dyadic relations, and in this way we can define three types of degenerate signs:

1. Icons, that are signs understood by their own intrinsic properties where the object is nonexistent or "covered" by the sign, e.g. pictures, music.
2. Indices, that point directly to the object by reference or physical contiguity, e.g. a footprint in the sand. Indices are rather context free (the interpretant is withdrawn or absent) but presuppose a real object.
- 3, Symbols are signs that are just triggers establishing the connection between object and interpretant by convention. Example: a picture of a fish understood to refer to the early christian society of Rome (without the historically delivered convention of interpretation it would be an icon).

These three types of signs are to be regarded as anchorpoints in a continuum of signs in order that an arbitrary sign may be analyzed for its content of iconical, indexical, and symbolic elements. Peirce also introduced other types of classification resulting in 66 different classes of signs, but the

three types defined above are the most important. We see them for example in technical diagrams where iconic parts (inductors, resistors, etc.) are clad with symbols (L,R,- -) and indices are used as subscripts (L_1 , L_2) to distinguish between various objects of the same kind.

Returning now to the discussion of quantum- versus classical physics we can start by depicting the classical notion of causality in the bond graph notation referring to Peirce's categories:

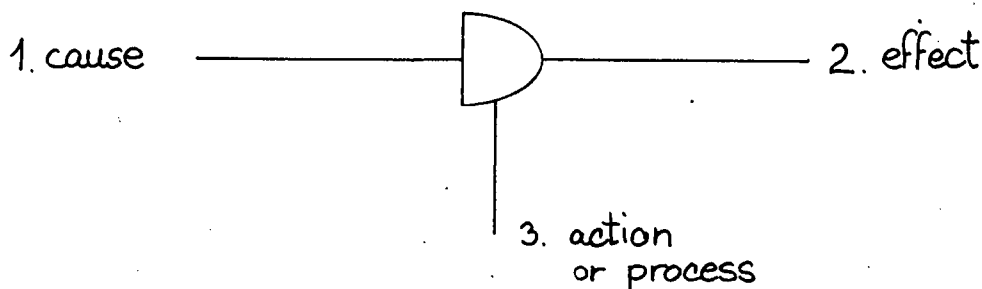

Fig. 2 Classical causality.

In choosing such a pictorial (iconic) representation of abstract concepts we deliberately evoke the association with signal carrying wires and electronic devices. In fig. 2 above the bonds are information bonds each carrying one well defined signal like the voltages of the wires on the front board of a programmed analog computer. We know then that the description of the wires as information bonds is not strictly true: in reality they are energy bonds because physical information cannot be carried without energy transfer. Correspondingly, it cannot only be the voltages that play a role in an analog computer, there must also be a current in the wire in order that a process may develop as a result of interaction between the parts connected with the wire.

In an analog computer the currents are suppressed, i.e. they have to be small in order that the voltages may be considered truly information carrying signals. This is achieved by the operation of active devices hidden behind the panel: the operational amplifiers. We say therefore that energy bonds have been activated, and we can state a general conception of the relational logic of physical systems:

An information bond is an activated energy bond.

An energy bond is then a physical realization of the more general concept

of an interaction bond. We can analyze an interaction bond by introducing two indexical signs for the dual concepts of effort (the voltage) and flow, an arrow for the flow and a stroke for the effort together with the convention that the index closest to a system component is considered causally independent of that component (an input variable) but dependent (output) from the system component in the opposite end of the bond: (note that the arrow does not signify the direction of causality but only indicates the orientation convention for the flow).



Fig. 3 Interaction bond connecting two system components A and B with dual indices of effort and flow defining the causality of interaction.

We can then read the interaction causality of fig. 3 in the following way: The effort is output from A and input to B whereas the flow is output from B and input to A. In general we will expect that the output from a system is somehow correlated with the input, so the causal situation is that the input to A (f) influences the output from A (e) which is the input to B influencing the output from B (f) which is the input to A, i.e. a circular causality.

If we could just translate the energy bond to two information bonds carrying signals the two opposite ways then we could also translate the indexical signs to symbolic signal variables having definite numerical values, and if we knew one of these values we could presumably find the other by solving a set of simultaneous equations. This is the normal way to treat interaction bonds for classical situations and it leads back to the causality concept of fig. 2 except in singular cases where "causal conflicts" may arise e.g. if the simultaneous equations have no unique solution. However, this translation cannot in general be strictly valid for physical systems where we consider an energy bond to be a more primitive concept than an information bond. By our thesis above we would then translate one unactivated energy bond to two activated energy bonds which is to explain something simple with something

complicated, i.e. it may be a simulation but it is not a translation.

In a quantum mechanical context we must accept that the energy bond is an irreducible concept, and information bonds belong to the classical world although they may influence quantum systems (classical fields). The process of measurement can then be thought of as a means of activation of the energy bonds. In this way we can obtain a synéchistic understanding of how our symbolic concepts are related to results of measurement which again are related to indexical signs of nature through a continuous chain of physical and semiotic transformations.

The measurement process regarded semiotically is then the decisive transformation from index to symbol so it must be described with a genuine triadic relation. The bonds entering this relation must be energy bonds, so we cannot translate or explain the structure using the classical concepts of causality. In order to identify the categories we must try to classify the system components in the other end of the bonds, and here we can use the traditional system-science discrimination according to the "degree of activity" of systems which again is an example of the applicability of Peirce's three categories. According to formal system-science as exemplified by Paynter's energy bond formalism we can distinguish between the following three categories of systems:

1. Active systems whose output are independent of the input, i.e. sources of effort or flow.
2. Reactive/passive systems whose output depend deterministically on the previous and the present values of the input. If the previous input values determine the present output we say that the system is reactive, but if the input-output relation is simultaneous we say that the system is passive (this distinction is not so important here). Examples of reactive systems are the storage elements of potential and kinetic energy like capacitors and inductors. Passive behavior we find in reversible two-ports like ideal transformers, transducers and gyrators and in the two triadic elements, the 0-junction and the 1-junction representing respectively Kirchhoff's current and voltage law. All the systems in this category are reversible and it is the only category that is used for modelling a purely mechanical system.
3. Dissipative systems, i.e. sinks of energy like an ohmic resistor. These systems mediate between the two previous categories. In a normal macroscopic context they can be described as almost passive, but according to the fluctuation-dissipation theorem they are always noisy, i.e. there is an active component in their output. Dissipative systems are mediating.

in every instance of control: If we want to change the state of a reactive system we will influence it from an active system, e.g. a thermodynamic reservoir, but this will in general produce perpetual oscillations around the wanted state unless dissipative processes bring it to rest.

It should be clear from this discussion that all three of the above categories enter a genuine triadic relation as well for the preparation as for the measurement of a quantum mechanical system. In both cases the source of control acts from the classical world upon the quantum system and the process is mediated by dissipative laboratory equipment. The semiotic discussion of the measurement process is therefore based on the following bond graph relation:

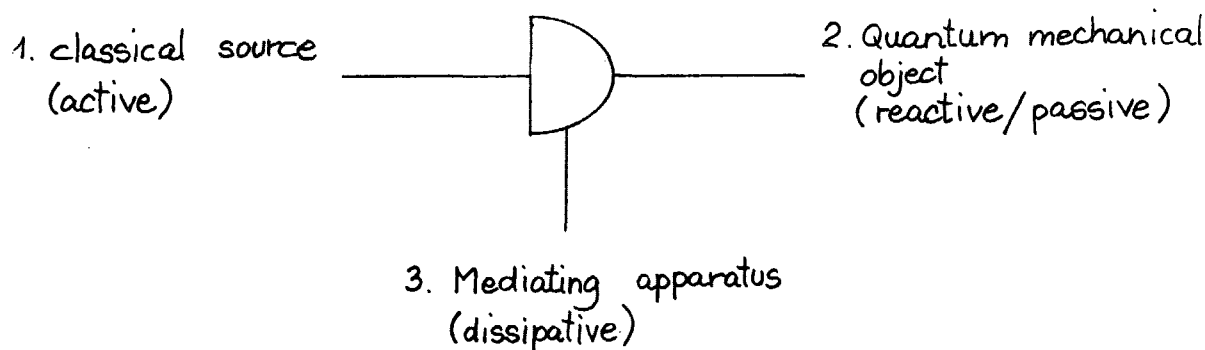

Fig. 4 Bond graph relation of quantum measurement.

By comparison between the classical causal relation of fig. 2 and the measurement relation of fig. 4 we note a certain similarity but also an important difference. In the latter case the bonds are energy bonds, not signal carrying information bonds, and if we want to simulate the process by postulating signals in the bonds then these must be dual signals of opposite directions in each bond and there must be a source of noise associated with the dissipative system according to the fluctuation-dissipation theorem.

It is important to note the difference between an energy bond connected with an active system and an activated bond or information bond. The input in bond 1 to the triadic relation of fig. 4 is determined by an active system, the classical source, but the output in bond 1 ought to carry information if the process considered is to be measurement and it is therefore not suppressed, i.e. bond 1 is not activated. The output information is entering the input

port of an amplifier that acts as an activator, i.e. on the other side of the amplifier we find a physical information bond. In the physical information bonds we are allowed to consider one of the dual variables as a classical signal with a well defined symbolic representation, but not the other which is suppressed. This does not mean that the suppressed variable is nonexistent and irrelevant for the discussion, on the contrary, as we shall see in the following sections, but just that it does not possess a symbolic representation. As an indexical sign it exists and plays a role in the process "setting the quality of the jump" as Kierkegaard said and this is because the physical information bonds are an integral part of the classical description of the experimental setup.

Where does then the physical description end? It must end at the precise place where the preset physical information bonds end, i.e. where some permanent mark of registration is made. From there on we can still speak of information transfer through data bonds and semiotic transformations but there is no question of back-action through the data bonds, because the data processing can be postponed until after the physical measurement process.

We can sum up the discussion with the following bond graph model where the data bonds are shown as dotted lines:

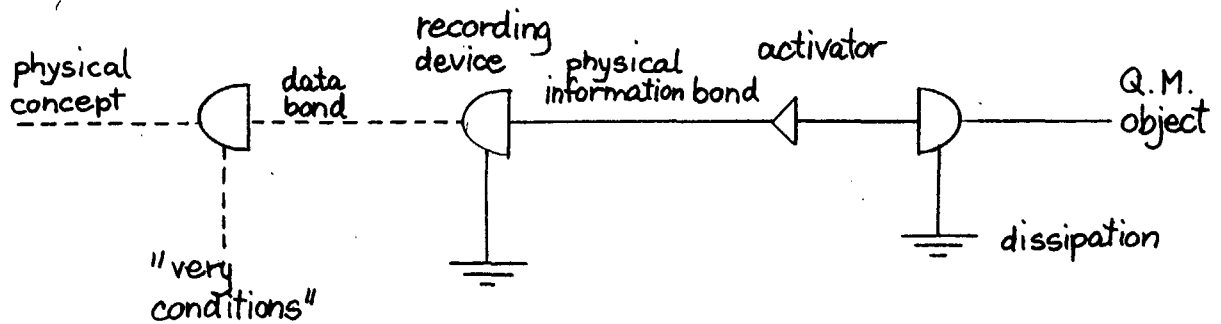

Fig. 5 Semiotic chain of measurement and data processing.

This model should illustrate that the "very conditions" Bohr speaks about lie outside the physical system and can have no influence on the measuring process in a synechistic description. The conditions that have an influence and may affect the quantum mechanical state must be located within the preset system of physical relations and bonds.

5. Zero point noise as a sign of consistency.

Quantum mechanics was born at the turn of the century out of a paradox showing the incompleteness of classical statistical mechanics: The Raleigh-Jeans formula for the spectrum of black body radiation which diverged at high frequencies. This divergence, the so called ultraviolet catastrophe, was resolved by Planck by the introduction of the quantum of action. Planck's analysis led to the new formula for the thermal energy of a harmonic oscillator with frequency ν at temperature T :

$$U_{\nu,T} = \frac{h\nu}{e^{h\nu/kT} - 1} \tag{1}$$

an expression that reproduces the classical expression kT for small frequencies but goes to zero exponentially at high frequencies which is fast enough to win over the power law increase (ν^{d-1} in d dimensions) of the phase space factor such that the divergence vanishes.

The subsequent formalistic development showed that there was a term missing in Planck's expression: the zero point energy

$$E_{\nu,0} = \frac{1}{2} h\nu \tag{2}$$

It was lucky for Planck and for quantum mechanics that he didn't discover this term, for if he had there would have been no resolution of the ultraviolet catastrophe, but an even more drastic catastrophe would have emerged. The theoretical discovery of the zero point energy came so late that it didn't shatter the faith in the consistency of the new formalism, it was more or less understood that there is a fundamental difference between thermal excitation and zero point motion. The latter is an intrinsic property of every quantum mechanical system related to the Heisenberg uncertainty relations, it cannot be transferred to another system by radiation and it is therefore invisible in the spectrum of the black body radiation.

Although the inclusion of the zero point noise faces us with the disagreeable task of explaining away an infinity of energy in a radiation cavity, at the same time it gives us the benediction of a much more rounded analytical expression for the oscillator energy

$$E_{\nu,T} = E_{\nu,0} + U_{\nu,T} = \frac{1}{2} h\nu \coth \frac{h\nu}{2kT} \tag{3}$$

an expression that is an even function of the frequency and matches the classical kT even better for small frequencies than Planck's formula (1). The ability of the quantum formalism to express the balance between absorption and emission of quanta of radiation by means of a single meromorphic function $S(\nu)$ of a complex frequency variable is a profound revelation conditioned by the existence of the zero point energy and indicates that this is not a weakness of the formalism that should be "renormalized" away as quickly as possible but rather a sign of consistency.

In 1928 it was shown by Nyquist that the problem of thermal noise in a resistor could be reduced to a one-dimensional radiation cavity and that the power spectrum could be expressed by the macroscopic coefficient of resistance without need of any microscopic model of the system. We are allowed to think of a resistor as a collection of independent oscillators whose eigenfrequencies are continuously and evenly distributed, each of them being thermally excited to the mean energy kT . The ultraviolet catastrophe inherent in the resulting spectrum of white noise disappears completely if the resistor is coupled to a linear reactive system like an inductor or a particle with inertia and leaves only the trace of the static classical fluctuation with mean energy $\frac{1}{2}kT$ per degree of freedom of the reactive system.

The discussion of classical noise generalized in the fluctuation-dissipation theorem leads directly into the triadic coupling of an active, a reactive, and a dissipative system similar to the one considered in fig. 4. If the active system is a flow-source then the combination of the reactive and the dissipative system (assumed linear) can be described with a frequency dependent complex impedance function $Z(\omega)$ ($\omega = 2\pi\nu$) and the power spectrum of the effort-fluctuations is then expressed by the real (dissipative) part of the impedance function for frequencies on the positive real axis:

$$P_e^T(\omega) = \frac{2}{\pi} Z_1(\omega) \cdot kT \quad (4)$$

An even simpler expression results if we Fourier-transform the impedance function to a time dependent rigidity response-function $G(t)$ and, by the Wiener-Khinchin theorem, introduce the autocorrelation function for the effort variable in the bond connected to the flow-source:

$$\langle e(t')e(t'+t) \rangle_T = kT G(|t|). \quad (5)$$

An example of such a triadic coupling of linear systems is shown in fig. 6 as an electric network and in energy bond graph notation:

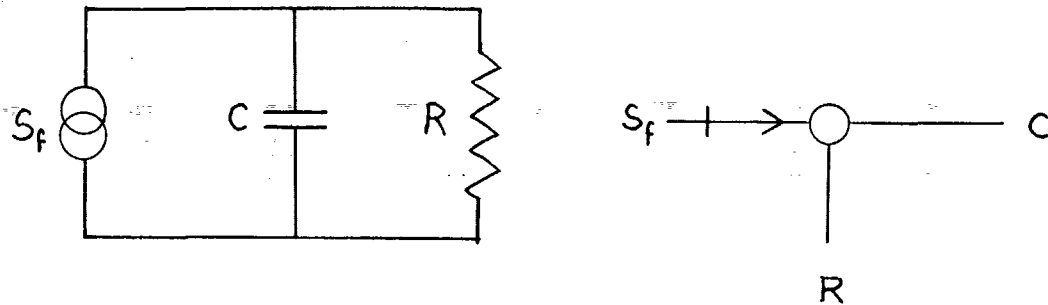

Fig. 6 Example of a triadic coupling of linear systems.

In this case the dissipative part of the impedance function is

$$Z_1(\omega) = \frac{R}{1 + \omega^2 \tau^2} \quad (\tau = RC) \quad (6)$$

and the time dependent rigidity function is

$$G(t) = \frac{1}{c} e^{-t/\tau} \quad (t > 0) \quad (7)$$

In general all three of the system categories enter in the discussion of thermal noise: the active system for identifying the controlled and the noisy variable (viz. flow and effort in fig. 6), the reactive system (the material aspect) for removing the ultraviolet catastrophe, and the dissipative system which ensures the ergodicity (well defined thermal equilibrium) and is the proper source of the noise. In accordance with Peirce's philosophy anything less than a genuine triadic relation of the system categories leads to an improper understanding of the concepts entering the fluctuation-dissipation theorem.

The quantum mechanical generalization of the theorem, made by Callen and Welton in 1951^{13.}, results simply in the substitution of the classical oscillator energy in eq. (4) with the full quantum mechanical oscillator energy of eq. (3), i.e.

$$P_e^T(\omega) = \frac{1}{\pi} Z_1(\omega) \cdot \hbar\omega \cdot \coth \frac{\hbar\omega}{2kT} \quad (8)$$

In this case we cannot by Fourier transformation find a simple proportionality (like eq. (5)) between the time independent rigidity response and the autocorrelation function because the oscillator energy is now frequency dependent, but this is not so serious. The most important new feature introduced by the finite quantum of action is the existence of zero point noise at $T = 0$:

$$P_e^0(\omega) = \frac{\hbar\omega}{\pi} Z_1(\omega) \quad (9)$$

The zero point noise exists at all temperatures but is superposed with thermal noise for $T > 0$. Just like in the discussion of black body radiation we must imagine two entirely different sorts of noise: the thermal noise is a "coherent" sort that can be transferred or radiated away to another system of lower temperature, but the zero point noise is non-transferable and intrinsic to the system considered, or rather intrinsic to any genuine triadic relation with an active and a dissipative system the quantum mechanical object may participate in.

The close connection between the zero point noise and the Heisenberg uncertainty relation was pointed out by I. R. Senitzky in 1960¹⁴. By considering a damped harmonic oscillator as his model system Senitzky showed that the pure effect of damping could be described with the usual Heisenberg equations of motion by adding an imaginary term proportional to the damping to the Hamiltonian operator of the undamped oscillator. This, however, has the unwanted side effect that the displacement-momentum commutator becomes time dependent and relaxes with the same rate as the classical oscillator. In other words: the Hamiltonian description of pure damping contradicts the Heisenberg uncertainty relations and brings us back to a purely classical deterministic theory which is clearly inconsistent. There can therefore be no Hamiltonian theory of damping, and this is because the concept of deterministic damping (dissipation) rests on a false conceptual logic. In order to preserve indeterminacy the damping effect must be balanced with a source of noise and this is just what the fluctuation-dissipation theorem states. The thermal fluctuations are produced by thermal noise, whereas the intrinsic fluctuations in a pure quantum mechanical state are produced by the zero point noise.

The fact that the fluctuation-dissipation theorem including zero point noise follows rigorously from the quantum formalism via response theory (e.g.

a Kubo formula) is a sign of consistency because the zero point noise can be regarded as the source of quantum indeterminacy and thereby an indispensable concept in the semantic discussion of the symbols of quantum mechanics. By accepting the reality of zero point noise in any genuine triadic systems relation we can begin to see how a physical theory based on semiotics may provide a justification and a limitation for Bohr's semantic thesis that the meaning of a wave function lies in the prescription of probabilities in connection with a classically described experimental setup.

6. The qualitative jump.

The semiotic problem of choosing the simplest possible model of measurement is easily solved with reference to the pioneering works of v. Neumann and Dirac. V. Neumann introduced an information theoretical approach by answering the question: how is the "atom of information", the binary question, represented by the quantum mechanical formalism? The answer is that any observable A is represented by a Hermitean operator \hat{A} that can be "spectrally resolved" into a weighted sum of projection operators \hat{P}_i whose only eigenvalues are zero and one:

$$\hat{A} = \sum a_i \hat{P}_i \tag{10}$$

where the a_i s are the real eigenvalues of the operator \hat{A} . The projection operators form a complete orthogonal system and therefore represent a semantically invariant transformation, a meaning preserving translation of the "question" A to a set of mutually exclusive yes/no questions. If two different observables are represented by the same set of projection operators they are quantum mechanically compatible, i.e. they can be measured simultaneously with the same set of "counters" which means that the physical discussion of measurement can be reduced to the discussion of a single counter (counting only to 0 or 1). This is of course a logical reduction, not a physical one at first blush, but as a physical measurement is an implementation of the logic of observation we should not be surprised to find that a real apparatus at closer inspection reveals itself as a collection of counters. For example: if we measure the position of a particle by means of a photographic plate the measurement is reduced to the counters corresponding to the separate grains of the photographic emulsion. In fact the logic seems to be so compelling that we can safely regard the binary counter as an irreducible com-

ponent of an ideal measurement in the pragmatic sense of the word, i.e. an idea that governs the manufacturing of actual experimental equipment.

The next step in the discussion is to analyze the operation of a single counter in semiotic terms, i.e. as a physical setting of a sign relation. We have already seen that this consideration leads to the energy bond graph model of fig. 4. This triadic relation is then the crucial link between the symbols of measurement results and the symbols of the quantum mechanical formalism, and in accordance with Bohr's semantic thesis we shall regard it as the place where the meaning of the quantum symbols originates. The use of semiotic terms is valuable in order to provide a general philosophical background but it should not obscure the content of which the main part has been discovered by physicists in the evolution of the quantum formalism. We have already seen that there are close connections between the epistemological ideas of Peirce and Bohr; now we are interested in the more specific development of formalism it is important to note how some of the more formalistic ideas of semiotics emerge in the work of Dirac.

A semiotician would say that the construction of symbolic concepts of physics proceeds via the preliminary sign categories of icons and indices. We start by considering an icon, e.g. the concept of a material particle, then we identify the indexical qualities that can be measured, e.g. inertia, velocity, etc., and finally the conventions of physical standards are used in connection with a measurement procedure to establish the symbolic concepts. For example the vectorial notation \vec{v} for the velocity of a particle without reference to a coordinate system is indexical in comparison with the symbolic coordinate representation that presupposes the convention of a basis set of orthogonal vectors. Historically the invention of the indexical vector notation came after the symbolical coordinate representation and it seems that the theoretical development has been much retarded by a neglect of a semiotic categorization and an illusory belief in the existence of context-free symbols in nature. Similarly in quantum mechanics: the symbolic concepts of Schrödinger's wave functions and Heisenberg's matrices were invented first and their final theoretical unification in the transformation theory was conditioned by Dirac's invention of an indexical notation: the "bras" and "kets".

The dualistic nature of the bra and ket vector spaces is closely connected with the semiotic idea that the constitutive sign relation of fig. 4 is set by interaction- or energy bonds. In a general interaction (energy) bond we can regard the dual indexical signs (effort and flow) as vectors belonging to dual vector spaces that are connected through the formation of a scalar inner product (the rate of energy transfer). We can distinguish between

the two dual spaces by calling them contravariant and covariant, or kets and bras, the meaning is the same and rests in the definition of the inner product, the bra-ket $\langle | \rangle$. The semiotic concept of the energy bond as the link between the classical and the quantum world is therefore sufficient to relate the indexical signs of the formalism to the concepts of dual vector spaces.

When we describe an isolated quantum mechanical system we can try to put up an equation for the rate of change of a state vector in either of the two dual spaces. In doing so we choose to refer to the state of the system with a sign that is more indexical, i.e. less context dependent, than Schrödinger's wave function, and this is appropriate when we describe the quantum world left to itself. We cannot apply Bohr's semantic thesis to this sign for it has no meaning except its direct reference to the object. The structure of the guiding equation must be reducible to an energy bond graph model (normally an infinitesimal segment that can be repeated in 1, 2 or 3 dimensions). There can be no concepts in the quantum formalism that cannot be brought back to the fundamental concept of the energy bond. The related discovery that the Schrödinger equation and equations of quantum field theory can be translated to electrical network structures was published in 1939 in the monumental monograph of G. Kron¹⁵; a similar viewpoint can be found in Brillouin's "Wave Propagation in Periodic Structures".

A general quantum mechanical energy bond represents some n-dimensional subspace of the Hilbert space and it can be decomposed into n elementary bonds, each corresponding to a ray, i.e. a one-dimensional subspace. Every choice of an orthogonal basis for the Hilbert space is then equivalent to the decomposition of a general vector bond into rays. We have seen that an observable and the corresponding apparatus of measurement can be analyzed as a collection of mutually exclusive binary counting operations, so we see that the indexical function of bond 2 in the model of fig. 4 consists in the identification of a ray of Hilbert space. Up to this point the semiotic discussion leads to the same point of view that can be found in other theories, e.g. the quantum logic of Jauch and Piron and the measuring theory of Ludwig¹⁶.

We can see how a collection of counters serve to establish an orthogonal set of basis vectors for the space of possible state vectors, and these basis vectors have a special physical significance because they are "setting the quality of the jump" i.e. defining the possible outcomes of which only one is realized by the quantum collapse of the state vector during measurement. It has no meaning to speak of a collapse unless these possibilities are set up in advance, but this also means that the preset counters must have a way of making a physical influence on the quantum system before the col-

lapse and there must be a random element in this influence.

Here we must be very careful. It is tempting to think of the dissipative noise that must be inherent in the triadic bond graph model of fig. 4 as a sort of perturbing random Hamiltonian acting on the pure state vector of the object and thereby gradually randomizing its phases such that its density matrix becomes diagonalized to a probability distribution. The idea of gradual phase randomization has been prominent in important theories of measurement, e.g. the theory of Daneri, Loinger, and Prosperi ^{17.}, and by use of the fluctuation-dissipation theorem it could be made to appear very simple and rather convincing. It would also be sufficient in order to point out the important role of the connectedness of the experimental setup thus giving a hint of what makes the quantum formalism valid in the correlation experiments of Aspect and others. But there is something very important missing in such a description: a diagonalized density matrix is conceptually very different from a probability distribution although its mathematical representation is the same. When we speak of a probability distribution over a discrete set of events we know that just one of these events is realized or going to be realized, but this is not the case when we speak of quantum mechanical density matrix that has been gradually phase randomized to a diagonal form. In the latter case the qualitative jump is missing.

We are looking here at the very problem that Kierkegaard wrote so much about. No matter how hard we try to make a description of the jump in continuous time we will always miss it. This is because we try to employ ideas of causality that are basically classical to a phenomenon that defies this notion of causality.

When we consider the initial stage of a measurement process before the collapse but after the physical setting of the triadic bond graph relation of fig. 4 we can imagine the existence of virtual small excitations of the bond graph variables as required by the fluctuation-dissipation theorem. We cannot locate the origin of such disturbances in one particular subsystem entering the relation although the conventional concept of noise would tend to locate it in the dissipative system and the conventional logic of measurement would tend to locate it in the reactive quantum system. The zero point noise is "non local" in the sense that it is a property of the genuine triadic relation as a whole, not of any of its constituent systems. This does not exclude a simulation of it in strictly local terms, but it should prevent us from attaching any ontological status to such a simulation. The local realism or synechism of our semiotic models has nothing to do with the localiza-

bility of causes, for the linear causal thinking is suspended for a while, but it is expressed by the continuity of interaction through space, i.e. by the connectedness of the sign generating bond graph models.

Let us take a close look at the possibilities for simulating zero point noise in connection with the model of fig. 6 in order to see if anything like a qualitative jump might emerge. The noisy variable will in this case be the effort which is the same for all three systems connected in parallel (an 0-junction). As the fluctuation-dissipation-theorem is unable to distinguish between continuous "wave noise"

$$\tilde{e}(t) = \sum_k \tilde{e}_k \exp(-i\omega_k t) \quad (11)$$

and "particle noise" or shot noise

$$e'(t) = \sum_k e'_k \delta(t - t_k) \quad (12)$$

and we are looking for a jump, it will be better to use the "particle noise" model of eq. (12).

The dimensions of the bond variables effort and flow can be chosen such that the flow measures the rate of particle transfer, i.e. f has the dimension of a reciprocal time, and the e'_k 's in (12) will then have the dimension of action. We can then further "quantize" the model (12) to

$$e'(t) = h \sum_k \eta_k \delta(t - t_k) \quad (13)$$

where h is Planck's constant and η_k are random numbers, either +1 or -1. It will still be possible to simulate the arrival times t_k such that the fluctuation-dissipation theorem is satisfied. Of course the continuing noise of eq. (13) is not what we are interested in; we are trying to describe one single event, the first occurring after $t = 0$, as a model of the qualitative jump. When this has occurred the situation is quite different, some non-linear process has taken place and the linear characteristics used in the construction of the model (13) for the virtual excitations are no longer valid. Thus we shall only use one of the terms in eq. (13) describing the single event,

say at $t = t_1 > 0$:

$$e'(t) = h \delta(t - t_1) \tag{14}$$

and this single event must be associated with the detection of a particle, i.e. the flow conjugate to e' must be

$$f'(t) = -\delta(t - t_1) \tag{15}$$

Of course the two expressions (14) and (15) cannot be strictly valid, because that would mean an infinite energy transfer at $t = t_1$. The use of delta functions to convey the idea of a sudden jump means that there are two widely separated time scales involved: a micro-time τ_i that characterizes the internal dynamics of the model and a macro-time τ_M that characterizes the whole measurement process. If τ_i and τ_M are separated with many orders of magnitude we can have the macro-appearance of the two simultaneous delta functions, but on the micro-level they will be smooth functions slightly separated in time, like shown in fig. 7. The energy transfer is then finite (but indefinite) and there is always exactly one quantum of action involved in an event.

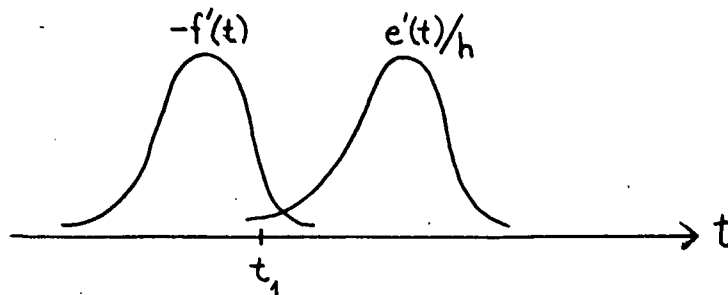

Fig. 7 A Microscopic view of the delta function expressions (14) and (15).

If the model shall be applicable we must then demand that the probability of an event has a nearly constant value for all times on the macroscopic scale, i.e. some orders of magnitude around τ_M , and that this value can be related to the quantum mechanical prescription of probability. For ordinary Poisson-type shot noise this demand can never be fulfilled because the waiting times are gamma-distributed (exponential for the first event) but for zero point noise it is in fact what we find, as we shall now see.

For the model on fig. 6 we can identify the microtime as

$$\tau_i = RC \quad (16)$$

By Fourier transforming the zero point power spectrum (9) we first get the time dependent autocorrelation function and if we integrate this expression twice over time (from 0 to t) and divide it by h^2 we find the following formula giving the average number of events between time 0 and time t:

$$N(t) = \rho \int_0^\infty \frac{1 - \cos \omega t}{\omega \cdot (1 + \omega^2 \tau_i^2)} d\omega \quad (17)$$

where ρ is the dimensionless parameter

$$\rho = \frac{R}{\pi^2 h} \quad (18)$$

In the limit $t \gg \tau_i$ we get

$$N(t) \approx \rho (\gamma + \ln \frac{t}{\tau_i}) = \rho \ln \frac{t}{\tau_i} \quad (19)$$

where $\gamma = 0.5772$ is Euler's constant. We see that if t is of the order τ_M , i.e. many orders of magnitude larger than τ_i , N(t) will have a nearly constant value

$$N(t) \approx N_0 = \rho \ln \frac{\tau_M}{\tau_i} \quad (20)$$

One may object that the impedance function we have used in (17) still

entails an ultraviolet catastrophe for the effort fluctuation. This is true but not important because we are interested in the width function $N(t)$ which is given by a convergent integral. The logarithmic behavior of $N(t)$ for large t is derived from the fact that the impedance has a finite value R for small frequencies and will not be disturbed if we introduce a high frequency cut-off in order to remove the remaining trace of an ultraviolet catastrophe.

In order to get a more detailed picture we need to determine the waiting time distributions $P_n(t)$, i.e. the probability of having exactly n events in the time interval from 0 to t . We have then

$$N(t) = \sum_{n=0}^{\infty} n P_n(t) \quad (21)$$

and the P_n s are determined by the recursive formula

$$P_n(t) = \int_0^t p_1(t') P_{n-1}(t-t') dt' \quad (22)$$

where

$$p_1(t) = -\frac{d}{dt} P_0(t) \quad (23)$$

is the probability density for the first event. By Laplace transformation

$$\tilde{N}(s) = \int_0^{\infty} N(t) e^{-st} dt ; \quad \tilde{P}_n(s) = \int_0^{\infty} P_n(t) e^{-st} dt \quad (24)$$

and use of eq.s (21) - (23) we find the following general formula valid for all types of discrete noise

$$\begin{aligned} \tilde{P}_0(s) &= [s(s\tilde{N}(s) + 1)]^{-1} \\ \tilde{P}_n(s) &= [1 - s\tilde{P}_0(s)]^n \tilde{P}_0(s) \end{aligned} \quad (25)$$

and

so it becomes possible by the inverse Laplace transformation to determine the whole family $P_n(t)$ from the single function $N(t)$ which is derived directly from the fluctuation-dissipation theorem. (A more detailed account of this derivation can be found in the appendix).

The above derivation based on the fluctuation-dissipation theorem for the width function $N(t)$ is based on the assumption that it is possible to define a time homogeneous ensemble describing the noisy system. On the other hand eq.s (21) and (22) assume that the ensemble is selected by the criterion that an event has taken place at $t = 0$ and the waiting time distributions will in general reflect a non-markoffian memory of the last event. There is no conflict between these two assumptions although it may sound so. The "event" at $t = 0$ should not be regarded as a real event but only as a selection criterion for a time homogeneous ensemble, the only possible criterion for a non-markoffian discrete stochastic process. The markoffian Poisson-process is exceptional by allowing time zero to be an arbitrary instant between events.

We are not interested in the general solution but only in the special case when $N(t)$ is nearly time independent as described by eq. (20). In this case we can show that

$$P_0(t) \approx \frac{1}{1+N(t)} \approx \frac{1}{1+N_0} \quad (26)$$

i. e. the probability of having no event up to time t is also nearly constant on the macroscopic time scale, and similarly for the other functions $P_n(t)$ which will give a geometric distribution for the number of events, n , i.e. quite different from the ordinary Poisson process.

As said before we shall only use the noise model until the first event has taken place which means that the only interesting function is $P_0(t)$ and the probability of having one event is not the $P_1(t)$ of the waiting time distribution family, but instead:

$$\hat{P}_1(t) = 1 - P_0(t) \approx \frac{N_0}{1+N_0} \quad (27)$$

This is then the expression that should be identified with the quantum mechanical prescription

$$\hat{P}_1 = |c|^2 \quad (28)$$

Where c is the expansion coefficient of the state vector or wave function after the ray of Hilbert space that has been set up by the counter in question. So comparing (27) and (28) we find that N_0 should be

$$N_0 = \frac{|c|^2}{1-|c|^2} \quad (29)$$

which, according to (20) means that the dissipative parameter ρ should have the value

$$\rho = \frac{1}{\ln \frac{\epsilon_M}{\tau}} \cdot \frac{|c|^2}{1-|c|^2} \quad (30)$$

At first sight this expression looks a bit artificial, but we shall see that there is a natural explanation for it. The divergence for $|c|^2 = 1$ means that the linear description of virtual excitations breaks down at this value because we here have a transition from probability to certainty of an event. Such a breakdown of a linear response theory is well known, e.g. in mean field theories of phase transitions, and it can be described most generally as the onset of instability of a positive feedback loop. In our model of a counter (fig. 4 and fig. 6) we can find such a transition if we assume that the active system in the relation presents itself to the virtual excitations as a negative resistance $-R_a$. If the passive resistance of the dissipative system is R_p (positive) we get the following expression for the effective resistance

$$\frac{1}{R} = \frac{1}{R_p} - \frac{1}{R_a} \quad , \quad \text{i.e.} \quad R = \frac{R_p}{1 - R_p/R_a} \quad (31)$$

so we see that the way the dissipative parameter ρ depends on the probability $|c|^2$ follows from the simple ansatz

$$\begin{aligned} R_a &= R' && \text{(a constant)} \\ R_p &= R' \cdot |c|^2 \end{aligned} \quad (32)$$

The constant R' should then have the definite value that satisfies eq. (30), i.e.

$$R' = \frac{\pi^2 h}{\ln \frac{\tau_M}{\tau'}} \quad (33)$$

This then raises the question if a measurement apparatus should always contain a "resistance" that is exactly tuned to the value (33) in order to satisfy the quantum mechanical prescription of probabilities? The answer is no! The value of a resistance depends on the exact symbolic fixation of the energy bond variables, an ideal scaling transformation $e' \rightarrow Te'$, $f' \rightarrow f'/T$ will transform a resistance according to the rule $R' \rightarrow T^2 R'$. This means that the value of the resistance is only well defined after a scale of measurement has been chosen, but this is exactly what we have done in deriving the expression (33). Thus there is a bootstrapping logic involved: the jump is setting the quality, as Kierkegaard said, although it at the same time is preset by the quality.

This again brings us back to Bohr's semantic thesis. The meaning of a quantum mechanical expansion of a state vector after an orthogonal basis

$$|\psi\rangle = \sum_i c_i |i\rangle \quad (34)$$

rests in a classical description of a measurement apparatus. We have provided such a classical description and have seen how it lends meaning to the quantum symbols:

- a) By analyzing an apparatus as a collection of binary counters identifying the rays $T|i\rangle$.
- b) By using the linear model of fig. 6 in connection with the theory of zero point noise to see how the possibility of the jump emerges.
- c) By using the quantum prescription of probability $p_i = |c_i|^2$ to determine the resistance value (33) which fixes the scale of measurement (T) along the ray whereby the numerical value of c_i acquires its meaning.

It may be objected that the model of a measurement apparatus we have used is very crude. This, perhaps, is not so serious. The logic of measurement has here been regarded as belonging to the discipline of semiotics, not to physics proper, and quantum semiotics is concerned with the establishment of

quantum mechanical concepts not with detailed physical theories of actual equipment. The models we have used are designed to extract the basic semiotic features of an apparatus, the features that make it possible to set up physical sign relations, and if we have succeeded in this there is no urgent need to investigate more complex models. The "counter" is here described in local terms and if we want a more concrete picture we can think of a single grain or even a single molecule of a photoactive substance in a photographic plate. The process of amplification (development) following the irreversible activation of the molecule is in this case unimportant for the measurement process because it is retrospective, i.e. it is postponed until after the completed measurement.

A much more serious objection is that the meaning of the dissipative constant R' in eq. (33) is unclear. A quantum mechanical system may be regarded as having connections to many different dissipative systems in its environment. In fact it is often said (especially after the Aspect experiment) that "quantum mechanics has taught us to regard the universe as an unbroken whole, that cannot be divided into parts, everything depends on everything else, etc.". We need a discussion of which types of connections are relevant to the measurement problem, and this is the topic of the next section.

7. The concept of connectedness.

The energy bond is an abstract concept used in physical models as an iconical sign for connectedness. The indexical signs of effort and flow that can be attached to it are vectors belonging to dual vector spaces and they can be associated with symbols, i.e. numbers and dimension, only after the choice of a vectorial basis including a measurement prescription and standard. In general a given physical system can be "reticulated". i.e. conceptually structured as an energy bond graph model in many equivalent ways and if a certain basis seems more natural than others then it will also seem natural to choose the energy bonds as simply related to the natural basis vectors. However, what seems "natural" depends on the viewpoint whether we are most interested in a close resemblance with the physical reality as it appears or in theoretical simplicity. It is therefore practical sometimes to have several choices of basis represented iconically within the same model and this can always be achieved by insertion of general tensorial transformers consisting of ideal passive 2-ports and 3-ports in an energy bond. For example, if we consider transmission of electrical energy the reticulation of physi-

cal resemblance may contain two energy bonds, because two wires are used, but a theoretically simpler reticulation regards the double-wire as a unit to be described with a single energy bond. The tensorial transformer connecting the two representations will in this case be an 1-junction (a series connection) as shown in fig. 8.

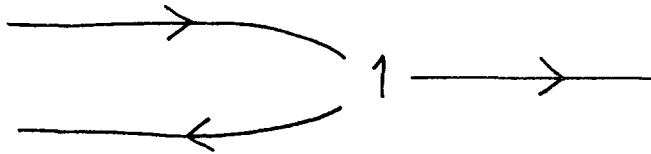

Fig. 8 Reticulation of electrical energy transmission cable as a double wire (to the left of the 1-junction) and as a single cable (to the right).

We can regard the 1-junction in fig. 8 in two ways: either as a dyadic transformer between two different representations of a one-dimensional subspace (a ray) within a higher dimensional space, or as a genuine triadic relation. In the same moment we choose to regard it as a genuine triadic relation we are forced to interpret the three bonds in the same way, as double wires, the two bonds on the left being associated with a common "earth" as illustrated in fig. 9.

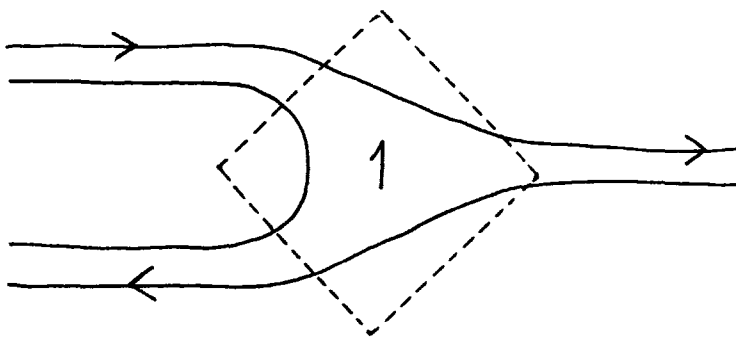

Fig. 9 The diagram of fig. 8 regarded as a genuine triadic relation of double-wire energy bonds.

This example should illustrate that when we have a genuine triadic relation of general vector bonds the three bonds entering the relation must necessarily have the same vector character. If a triadic relation for example involves two n -dimensional vector bonds and one bond of dimension $n-1$ then it is not a genuine but a degenerate relation in n dimensions and it can be reduced in the simplest cases to a genuine triadic relation in $n-1$ dimensions and another relation of lower rank, like a mechanical constraint. (For non-holonomic constraints, as for example the rolling of a sphere on a plane it will be necessary to carry the reduction further and it will involve active, monadic relations representing boundary conditions).

The synechistic viewpoint on the measurement problem regards a measurement as a physical setting of a sign relation, i.e. a genuine triadic relation of energy bonds. Furthermore, we have seen that the meaning of a quantum mechanical wavefunction is constituted by the measurement relation, in accordance with Bohr's semantic thesis. This consideration then accentuates the naive viewpoint that was brought forward in sec. 2 in connection with Mermin's exposition of the quantum correlation experiments of Aspect and others: it is the connectedness (which Mermin considers "irrelevant") of the experimental setup that legalizes the theoretical use of the concept of a two-particle wave function, and the "non-local" correlations observed cannot exist if the single particle detectors were as unconnected as Mermin claims they are. There is nothing strange or supernatural in finding two-particle correlations violating Bell's inequality, indeed these are explained very simply by using the concept of collapse of a two-particle wave function. But the explanation is semiotically worthless and non-synechistic if it cannot be documented "in a totally classical way" that the experimental equipment sets up a sign relation of counting where the associated ray of Hilbert space describes a genuine two-particle property. This means that the two distant single-particle detectors must be connected to a central coincidence counter (or another central black box), otherwise the measurement relation degenerates to two independent one-particle relations and the correlations will satisfy Bell's inequality.

The problem is now that "connectedness" is a mathematical abstraction; in the real world everything is connected with everything else, but there are strong connections and weak connections and we need a quantitative criterion in order to decide which connections are relevant in the measurement context and which are not. Intuitively one could say that the plainly visible wires connecting the single-particle detectors with the central black boxes in the

polarization correlation experiments must be relevant, but if the wires were removed and the signals sent by radio instead the radio links would be irrelevant connections. But apparently Mermin's intuition (or a hidden rational argument) has led him to the opposite conclusion as can be seen in the passage from his article quoted in sec. 2. So we need a more substantial argument to justify our intuition.

According to the fluctuation-dissipation theory of the qualitative jump outlined in the previous section a connection is characterized by a dissipative parameter ρ which is proportional to the mean square displacement in a diffusive motion of the phase of the wave function's projection on the ray in question. If we compare connections of different strength ρ we will find that the time needed before the phase diffusion due to a particular connection of strength ρ becomes significant varies approximately like $\exp(1/\rho)$ (comp. eq. (19) where $N = 1$ corresponds to a mean square phase displacement of $4\pi^2$). One special connection will be dominant and setting the quality of the jump, and the jump is setting the scale such that the largest ρ has the value (comp. eq. (33))

$$\rho_{\max} = \frac{1}{\ln \frac{\tau_M}{\tau'}} \quad (35)$$

For an ideal measurement the time scales τ_M and τ' are widely separated, so ρ_{\max} will be a small number. The exponential dependence on ρ of the characteristic diffusion time for the other connections then makes it plausible that these will not be able to influence the phase significantly during the measurement time τ_M , and thus we find that only one connection is relevant and this is the one set up by the measuring apparatus.

By adopting the dissipative response parameter ρ as the measure of strength of a connection we can justify the intuitive feeling that the connection established by a radio antenna radiating out into three-dimensional space to some distant receiver is very weak compared to a one-dimensional conductor or wave guide. The dominating resistance felt by a radio antenna is determined by the empty space and not by the receiver, so, if vacuum is an irrelevant connection, so is a radio link. The success of the Aspect experiments in demonstrating that the exact quantum correlations are maintained over distances up to 13 m is a sufficient experimental proof that the vacuum connections and fluctuations are irrelevant under normal laboratory circumstances. Before the last "switching" experiment ^{4c.} of Aspect the belief

expressed by Marshall ^{8a.} that vacuum fluctuations could communicate the setting of one polarizer to influence the detector at the other polarizer seemed to be a reasonable way of rescuing local realism, but this possibility is now ruled out by the switching experiment.

The earlier conception of local realism was tied up with the ideas of localizability of causes and symbolic hidden variables. The Aspect experiments have given good reasons for abandoning these ideas. But this does not exclude a local realism based on the continuity of interaction, i.e. synechism, with the semiotic logic of signs and relations. With the synechistic concept of local realism, as outlined in this paper, the difference between the non-switching and the switching experiments of Aspect's seems not so important, for the relevant connections are preset and unswitched over the whole experiment in all cases. These are the physical bonds connecting to the place where the final irreversible registration is made in the central black boxes, thus setting the quality of the collapse and the meaning of the wave function. If these connections were removed or sufficiently weakened we would simultaneously remove the very conditions for making predictions using the concepts of a two-particle wave function. If only single particles are detected by independent and unconnected detectors, the only applicable quantum mechanical concept is a weighted superposition of correlated products of single-particle density matrices, and such a construction will always satisfy Bell's inequality, as we shall see in the next section.

Although the synechistic concept of interaction causality has to dispense with the localizability of causes there is nothing to prevent us from simulating situations where signals propagate through the connecting wires. When we claim that a pair of wires leading to a central black box (coincidence counter) is a relevant connection setting up a ray of Hilbert space then we are also opening for the simulation of a process where disturbances originating in the central black box propagate "the wrong way" through the wires and create correlated disturbances at the two separated places where the single particles are detected. Such a simulation should not be regarded as a description of what actually happens in the real event of collapse of the two-particle wave function. The simulation expresses a linear, classical causal logic that is insufficient to grasp the idea of the qualitative jump. Indeed, it would be very unsatisfactory to say that the cause of a detection event lies in the counter, we would rather prefer to say that the cause is the real particles entering the detection chambers. But both descriptions are unsatisfactory because they both rest on the linear causality concept and the qualitative jump of the collapse can only be understood by the circular causal

logic of interaction. So. the possibility of simulating signals propagating "the wrong way" is insufficient as an explanation, but it is still necessary to have this possibility, otherwise the application of circular interaction causality would only be an empty postulate.

The question is now: if we consider the set of signals that could possibly travel the wrong way through amplifying devices, is this then an empty set? In the light of the discussion of the qualitative jump in the previous section it is clear that what we must look for are virtual small excitations of shot-noise type. For small signals a linear description will suffice, so what can we think of in linear systems that would permit signal propagation one way, but not the other way? Most linear two-ports are known to satisfy Onsager's reciprocity relations, but we also have antireciprocal linear two-ports called gyrators. Consider the composite two-port in fig. 10 that is a parallel combination (by 0-junctions) of a reciprocal conductance g and an anti-reciprocal gyrator, also with the magnitude g .

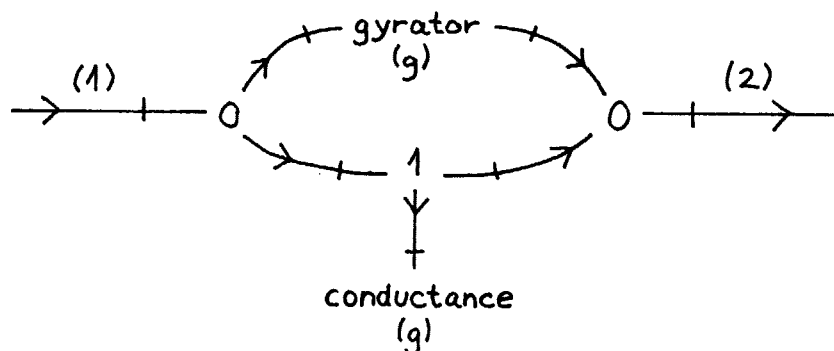

Fig. 10 Linear two-port that allows signal propagation from left to right but not from right to left.

With the flow-orientations chosen from left to right, as shown in fig. 10, the gyrator in the upper branch will have a symmetric response matrix with zeroes in the diagonal, and the lower branch involving the ohmic conductor will have non-diagonal elements of opposite signs, so the response relation of the combined system is:

$$\begin{pmatrix} f_1 \\ f_2 \end{pmatrix} = \left\{ \begin{pmatrix} 0 & g \\ g & 0 \end{pmatrix} + \begin{pmatrix} g & -g \\ g & -g \end{pmatrix} \right\} \begin{pmatrix} e_1 \\ e_2 \end{pmatrix} = \begin{pmatrix} g & 0 \\ 2g & -g \end{pmatrix} \begin{pmatrix} e_1 \\ e_2 \end{pmatrix} \quad (36)$$

(upper branch) (lower branch)

So we see for this model that an effort signal (e_2) propagating from right to left in bond 2 cannot be felt in bond 1. In fact the model in fig. 10, apart from dual symmetry, is the only possibility of a linear bond graph model that creates the situation of a one-way communication, and if we want to simulate the linear propagation of small signals through a one-way amplifier there can be no path that doesn't go through the simplified device of fig. 10 18.

However, there are good reasons why this device will not work the same way for zero point shot-noise. The dissipative conductance in fig. 10 would give rise to an ultraviolet catastrophe if there wasn't a reactive element hidden in it. This means that there must exist a microscopic characteristic time τ_i such that the lower branch of fig. 10 is a low pass filter that will only allow signals with frequency less than $1/\tau_i$ to pass through. But the simulation of zero point shot-noise is concerned with signals that vary rapidly on the microscopic time scale, so these signals can only go through the antireciprocal gyrator branch of fig. 10. There can therefore be no one-way communication on the microscopic time scale and the zero point shot-noise is passing only through reversible, reciprocal or antireciprocal two-ports.

If we consider a cascade coupling of amplifiers oriented from left to right (fig. 11) and ending in a recording device then the signals propagating the whole way from left to right will be amplified with a cumulative gain-factor $G = g_1 g_2 \dots g_n$. Because of the reciprocity or antireciprocity of each of the amplifiers on the microscopic time scale a zero point shot-noise impulse origination somewhere on the line will meet exactly the same gain-factors in the opposite order when it propagates to the left.

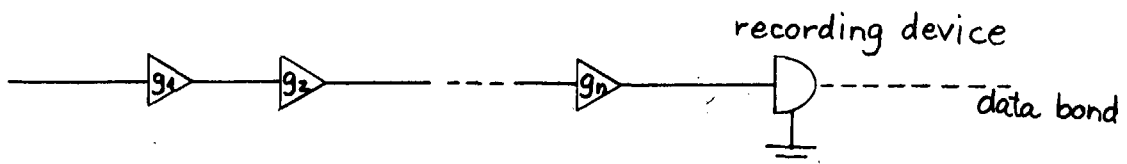

Fig. 11 Cascade coupling of amplifiers ending in a recording device.

If all the gain-factors g_1, g_2, \dots, g_n are greater than unity it will be the zero point noise originating in the recording device that will be amplified the most on the way to the left end, and this is quite opposite to the situation for classical signals whose leftward propagation is hindered by the bond activating amplifiers.

We see then that bond activation is a classical concept: the more we prevent classical signals from travelling "the wrong way" the easier we make it for the virtule zero point pulses to go just that way. However, this argument only applies to essentially one-dimensional connections and not, for example, to radiation through a two- or three-dimensional space and especially not to the data bonds associated with sign transformations that are not preset but postponed until after the physical process of measurement. Thus, the idea of a "retrospective collapse" that occurs, for example, when the human investigator who has been elsewhere drinking coffee during the experiment comes back and looks at the recorded results, is totally non-synechistic and should be buried as a misconception. The same can be said about the parapsychical ideas of consciousness as an agent acting through non-local hidden variables to affect the collapse. Of course synechism cannot exclude parapsychical effects, but in a physical context where physical synechism works there is no need to resort to parapsychical "explanations".

Having discussed the role of the amplifiers let us consider now the passive web of connections used in a coincidence monitored spin- or polarization correlation experiment. We assume that two particles, 1 and 2, each can be detected in two states denoted \uparrow and \downarrow as in a spin $\frac{1}{2}$ experiment, but it could just as well be parallel and perpendicular polarizations relative to the respective settings of the polarizers for particle 1 and 2 ^{4b}. Thus, we have 4 single-particle detectors: $1\uparrow$ and $1\downarrow$ at polarizer 1, and $2\uparrow$ and $2\downarrow$ at polarizer 2. There will also be 4 coincidence counters, denoted $1\uparrow 2\uparrow$, $1\uparrow 2\downarrow$, $1\downarrow 2\uparrow$, and $1\downarrow 2\downarrow$. If the output from a single-detector, e.g. $1\uparrow$, is a current pulse it shall be distributed evenly, through a 1-junction, to the two coincidence counters $1\uparrow 2\uparrow$ and $1\uparrow 2\downarrow$. On the other side a coincidence counter, e.g. $1\uparrow 2\uparrow$ shall receive the sum of the current pulses from the single-detectors $1\uparrow$ and $2\uparrow$ through a 0-junction. The whole scheme of passive connections is then described by the diagram of fig. 12.

We are thinking here of the simplest possible model of a coincidence counter: a parallel connection of a capacitor and a resistor. If it receives two pulses within a relaxation time the charge exceeds a critical value triggering counting whereas a single pulse is insufficient.

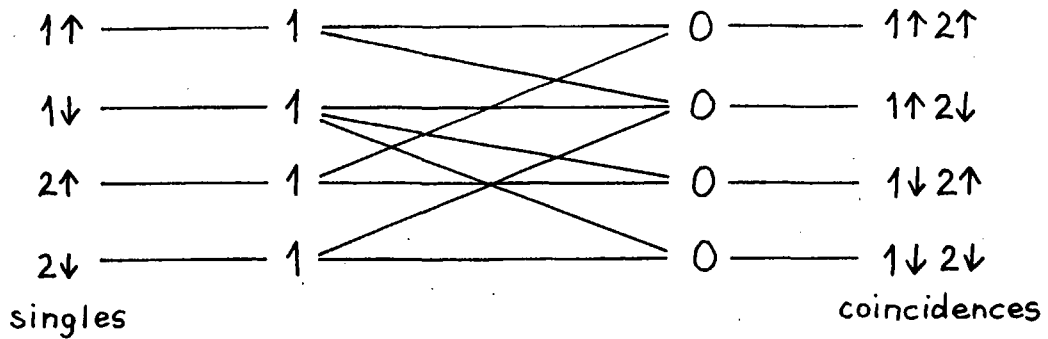

Fig. 12 Passive connections between single-particle- and coincidence counters.

The exact shape of the network of passive connections is not so important for our discussion. The important thing to note is that such a network of energy bond relations always has the reciprocity property, i.e. if the relations ensure that two simultaneous current pulses form the single-detectors $1\uparrow$ and $2\uparrow$ arrive simultaneously at the coincidence counter $1\uparrow 2\uparrow$ then they also ensure that a voltage pulse originating at $1\uparrow 2\uparrow$ will arrive simultaneously at $1\uparrow$ and $2\uparrow$. The whole network can be regarded as a tensorial transformer inserted in a 4-dimensional energy bond and the rays defined by the coincidence counters can be regarded as a basis for the Hilbert space of the two-particle system.

The simulation approach that forces us to consider the propagation of pulses through wires of considerable length raises some difficult questions. First, it is clear that the picture of two nearly simultaneous delta-function pulses (fig. 7) can only be valid in the immediate neighborhood of the single particle counters but not at the coincidence counters. Should we imagine that a pulse has started at the coincidence counters some time before the detection of a pair of particles and then travelled along the wires in order to arrive just in time for the single detections? Such a model would rely on the notion of backwards causality and is therefore just as strange as models proposed by Wheeler and others. Any physically reasonable model of simulation trying to localize the cause of the collapse must assume that the pulses originate where the single particles are detected. The role of the coincidence counters is then rather to coordinate or synchronize the detection of singles, and we can imagine that this synchronization is established through the previous history of correlated noise that has propagated from

the coincidence counters to the single detectors.

The second question is concerned with the uniqueness of the collapse event. We have analyzed a measurement as a collection of independent counters each defining a ray of Hilbert space, and we have seen that the probability of a detection event for a single counter, i , can be described with the quantum mechanical prescription $p_i = |c_i|^2$. But if the counters are independent one should think that the detection events are statistically independent such that there is a finite probability $p_i p_j$ that two different counters, i and j , both register an event even when there should be only one collapse. This would mean that the quantum mechanical probabilities only apply to an ensemble of similarly prepared systems, but not to the single system, as in the interpretations of Kemble, Ballentine and others¹⁹. However, continuing the line of reasoning, we could consider a situation where the different counters were all connected to a single "selector" that records which of the counters was activated. In this case we would expect that the collapse must be a unique event involving one and just one of the counters.

At present this is just speculation and the author prefers to think that the collapse is unique in all cases, whether there is a central selector-device connecting all the counters or not. After all, the counters are all connected to the real world of quantum phenomena and this may be the only selector we need. For the moment we may leave the question open because it is purely ontological and has no consequence for the experiments we are interested in.

8. The return to reality.

The main purpose of this paper has been to show that Peirce's conception of local realism, i.e. synechism, is compatible with quantum mechanics and that the experimental results obtained by Aspect and others, although they have falsified classical conceptions of local realism based on symbolic hidden variables, are not contradicting quantum semiotics and synechism. We have seen that quantum semiotics gives a theoretical foundation for Bohr's semantic thesis that the measurement process gives meaning to the wave function. On the other hand some of the points in Bohr's reply to EPR are at variance with the synechistic point of view and one cannot from this standpoint say that the very carefully formulated arguments of EPR, which do not depend on hidden variables, have been rejected, neither theoretically, nor by the experiments.

The lack of connectedness that has been emphasized in all the thought-

versions, from the original EPR experiment over Bohm's version²⁰. opening for the application of Bell's inequalities and to the brilliantly popularized version in Mermin's paper⁹, is from the synchistic viewpoint in sharp contrast to the strong connectedness via coincidence counters in the real experiments. Therefore, one can say that local realism of the synchistic variety has not been disproved by the real experiments, but the thought experiments for which the Bell inequalities are applicable may still be regarded as possible falsification tests for local realism, provided that their emphasis on the lack of connectedness is taken seriously.

Apparently, the idea that coincidence counters or other central black boxes may have an influence on the correlations measured has not been seriously considered by the authors of the thought experiments. When Mermin, for example, speaks of the lack of relevant connections he is thinking of a way of communication from one polarizer or single-particle detector to the other and not of connections to a central black box. A possible exception to this way of thinking is given by Aspect in his presentation of the idea of the switching experiment²¹. Aspect considered the possibility that the hidden variables, λ_1 and λ_2 , characterizing the two single-particle detectors were statistically correlated (and such a correlation could of course be due to the presence of a central black box), and he then proceeded to show that this correlation would not destroy the validity of Bell's inequalities. The argument, however, has no consequence for our present discussion because it rests on the assumption of local hidden variables, whereas we have seen that sufficiently strong connections to a central black box ensure that the quantum mechanical two-particle wave function is a valid concept.

Quantum mechanics cannot by itself state the exact conditions for the validity of its formalism which depends on a classically described measuring apparatus. In this way quantum mechanics is incomplete, but the incompleteness has nothing to do with hidden variables, and quantum semiotics is in accordance with the Copenhagen interpretation in this view. However, quantum semiotics goes a step further than the Copenhagen interpretation in pointing out the physical connections to the counters as a necessary condition for the reality of the associated quantum symbols. It is still difficult to formulate a sufficient condition which would require a detailed theory of actual measuring equipment and it seems dubious whether such an undertaking can lead to a clear result. Fortunately, there is a lot of experimental evidence showing that the concept of ideal measurements presupposed by quantum mechanics is not an empty postulate. We can feel reasonably confident that the pragmatic logic of experimentalism is precisely what the theory needs.

Here comes then a difficult point: When we propose an experiment, that may either falsify the synechistic theory outlined here or demonstrate the incompleteness of quantum mechanics, then the crucial feature of such an experiment, i.e. a deliberate weakening of the connections between various pieces of equipment, may be regarded as conflicting with a sound experimental praxis. Hence this long exposition that leads to some rather trivial proposals for experiments that could be stated on the back of an envelope. Good experimentalists are naturally proud of their skill and will not voluntarily weaken it unless there are good theoretical reasons for it. Such experiments will only be performed when it is realized by a sufficiently strong group of physicists that the epistemology of quantum semiotics and the ontology of synechism is a possible theoretical standpoint of some explanatory power and thus worth testing.

We shall consider three possible experiments that are all slight modifications of the original photon cascade experiment by Freedman and Clauser²² or of the first of Aspect's experiments (Aspect, Grangier, and Roger, 1981)^{4a}. Aspect's experiments have the merit of a long distance (13m) between the single-particle detectors which is desirable in order to ensure that the two photon wavepackets do not overlap in the moment of detection, and thus there is no possibility that one detection should be able to influence the other through a "quantum potential" inherent in the two-particle wave equation. The experiment of Freedman and Clauser has another merit in that it doesn't rely on corrections for accidental coincidences. Both these merits are desirable, but the far most important is that there shall be no question of accidental coincidences. In principle it should be easy to fulfil this demand by decreasing the counting rate of single photons sufficiently.

The diagram for the experiment is shown in fig. 13. The connections to the coincidence counter are shown with dotted lines. The three proposals we shall consider are just three different ways of weakening these connections.

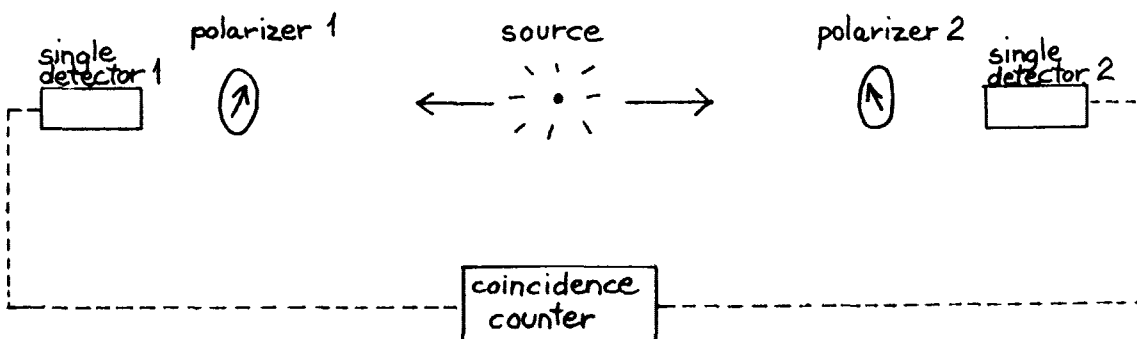

Fig. 13 Diagram of photon cascade experiment.

We shall not go into a detailed discussion of polarizer- and counter efficiencies etc. which can be found in the review article by Clauser and Shimony³, so we assume that the polarizers are ideal and that the "no enhancement" hypothesis of Clauser and Horne²³ is valid. The fraction of coincidences as a function of the angle θ between the polarizers is then according to quantum mechanics

$$G_{c,q}(\theta) = \frac{N_c(\theta)}{N_\infty} = \frac{1}{2} \cos^2 \theta \quad (37)$$

where N_∞ is the number of coincidences in the absence of polarizers.

Let us for a moment assume that a certain fraction γ were accidental coincidences. This would weaken the correlation such that the expression (37) should be replaced by

$$G_{c,r}(\theta) = \frac{1}{4} \gamma + (1 - \gamma) \cdot \frac{1}{2} \cos^2 \theta \quad (38)$$

If we had no way of identifying the fraction γ as accidental coincidences and found something that could be described with the expression (38) then we would have to accept it without correction. Bell's inequality will then be satisfied if

$$\gamma > \gamma_0 = 1 - \frac{1}{\sqrt{2}} \approx 0.29 \quad (39)$$

In Aspect's experiment the correction factor γ is about 0.4 so the resulting disagreement with Bell's inequality is strongly dependent on an explicit correction for accidental coincidences which were measured directly by a delayed coincidence counter and then subtracted from the total coincidence rate. This procedure was recently criticized in an interesting paper by E. Santos²⁴.

If the experiment were performed without connections to central black boxes it would be impossible to make a direct counting of accidental coincidences. It would then be necessary to have a sufficiently low counting rate of single photons such that the fraction of accidental coincidences could be considered negligible from statistical reasons alone. If then an expression

of the form (38) was measured, with $\gamma > \gamma_b$, it could only be explained by admitting that the two-particle wave function collapse was nonexistent and that only single particle measuring events were taking place.

According to the present theory the conjecture $\gamma > \gamma_b$ would be the weakest bid for the outcome of such an experiment. A much more reasonable prediction is $\gamma = \frac{1}{2}$, as we shall now see. Imagine first that the two photons were in a pure state where both photons are polarized in a direction \vec{n} having an angle u with the vertical. If the direction of polarizer 1 is vertical the amplitude for a detection of both particles would be

$$\langle 1 \parallel, 2 \parallel \mid 1 \vec{n}, 2 \vec{n} \rangle = \cos u \cdot \cos(u - \theta) \quad (40)$$

If the density matrices corresponding to such pure states are averaged with equal weight over all angles u we find the following expression replacing (37)

$$G_{c,s}(\theta) = \frac{1}{2\pi} \int_0^{2\pi} \cos^2 u \cdot \cos^2(u - \theta) du = \frac{1}{8} + \frac{1}{4} \cos^2 \theta \quad (41)$$

i.e. of the form (38) with $\gamma = \frac{1}{2}$.

This model that is based on a superposition of products of single-particle density matrices has been proposed several times. According to the Furry-hypothesis²⁵ a two-particle wave function would spontaneously degenerate into such a sum when the spatial wavepackets of the two particles no longer overlapped. This hypothesis was disproved by the Aspect experiment. According to the present theory there is no spontaneous degeneration of the pure two-particle state; the effect leading to (41) should rather be considered a sort of coarse graining due to a measuring equipment that because of its lack of connectedness is unable to define a two-particle collapse. The angle u plays now the same role as a hidden variable in Bell's theory, so any probability distribution for the factorized density matrices will lead to Bell's inequalities, But it is difficult to argue for any distribution except the uniform one that leads to the expression (41).

Let us now consider three different ways of weakening the connections to the central black box.

The first proposal is simply to remove any preset connections and coincidence counters (or time-to-amplitude converters, etc.). This would mean

that the coincidences have to be found retrospectively by comparison of sufficiently accurate time records of the detections of single particles. The diagram in fig. 13 is still applicable if we regard the connections shown as dotted lines as data bonds. Retrospective coincidence counting has been used earlier, notably in the famous experiment by Bothe and Geiger²⁶, but, to the knowledge of the author, never in cases where there is a conflict between orthodox quantum mechanics and a local realistic theory.

The second proposal is to use a preset coincidence counter with wireless radio links to transmit the single events instead of wires. This would be a test of the hypothesis put forward in the previous section that the relevant connections in an experimental setup are essentially one-dimensional and not radiation through higher dimensional spaces. Other modifications are possible by inserting a "weak link" in a wired connection one might be able to study a transition from the strongly connected case described by (37) to the unconnected case described by (41).

We can imagine a weak link in a one dimensional connection as a place where a package of information is formed and has to propagate further by pure diffusion (unlike the diffusion over the base layer of a transistor where the inertia of the injected particles is essential). Similarly, if the information package propagates like a soliton (e.g. a nerve pulse) or like a mailed letter. In such cases the information package has the character of a permanent record and its line of propagation has the semiotic character of a data bond without back action.

The third proposal is to keep the strong preset connections to a coincidence counter but to introduce an asymmetry in the placement of the source and to compensate for this by a sufficient delay in one of the connections to the coincidence counter. Until now we have tacitly assumed that the source is placed exactly midway between the two polarizers and single-particle detectors as has been the case in most of the experiments. Let us now assume that the source is displaced a piece x towards polarizer 1 such that there is a difference $\tau_x = 2x/c$ in the time of flight of the two photons. It is then necessary to compensate for this difference by inserting a passive delay τ_x in the wire from single-detector 1 to coincidence counter (e.g. by using a longer wire). We have seen that the logic of the collapse depends on the possibility of simulating a pulse that propagates from the coincidence counter to the single-particle detectors. Now such a pulse will arrive the time τ_x later at 1 than at 2, but the wavepacket of photon 1 arrives τ_x earlier than that of photon 2 and the wavepacket has a limited temporal exten-

sion τ_w , so if

$$\tau_x > \tau_w/2, \quad \text{i.e.} \quad x > x_c = \frac{1}{4} c \tau_w \quad (42)$$

there will be no possibility for the pulse to be there when both wave present and thus no possibility for a two-particle collapse. With the value $\tau_w = 5\text{ns}$ that is relevant for the cascade process used in the experiments we find $x_c \approx 40\text{cm}$. If the distance from the midpoint to the polarizers is 6.5m as in the Aspect experiment there should be ample space to study the transition from the regime of eq. (37) to that of eq. (41) by gradually increasing x from 0 to a value above x_c .

The argument above leading to a rather small value of x_c is perhaps too primitive because it relies on the concept of a single pulse propagating from the coincidence counters, and as we have seen in the previous section, if such a pulse should be responsible for the collapse we should accept the notion of backwards causality. The role of the coincidence counters is rather to synchronize the single detections within the window of coincidence and it seems therefore a more reasonable bid for the critical distance x_c if we substitute τ_c , the coincidence window, for τ_w in (42). In the Aspect experiments $\tau_c = 18\text{ns}$ which increases our estimate of x_c to 135cm . There will still be ample space and the previous estimate (40cm) retains its significance as a lower limit for x_c because the temporal extension of the wavepacket, τ_w , is a lower limit for the window of coincidence, τ_c .

An asymmetric placing of the source was tried in the experiment by Faraci et al. ²⁷. Their conclusion was for the case of greatest asymmetry that the result was in better agreement with a local realistic theory than with orthodox quantum mechanics. However, the uncertainties are too big to allow a conclusion to be drawn from this single result.

The three proposals have been ordered according to priority. The first is the clearest falsification test of the synechistic theory outlined in this paper. If it gives results in accordance with orthodox quantum mechanics after a retrospective data processing without any correction for accidental coincidences then one can safely conclude that this theory is wrong. On the other hand, a result in accordance with (41) would be a clear proof of the incompleteness of quantum mechanics and a good point in favor of the synechistic conception of local realism. The second and the third proposed experiments would not be relevant if synechism fails in the first test, but they are probably easier to perform, especially the second, and they can also be regarded as falsification tests, perhaps not as much for the basic view-

point of synechism but rather for more specific points in the present application of synechism and semiotics.

The author believes that the formalism of quantum mechanics when interpreted according to the semantic thesis of Niels Bohr is consistent but incomplete, like mathematics, according to Gödel. Local realism in its synechistic formulation (continuity of interaction) is compatible with all known dynamical equations and seems to contain so much explanatory power that the incompleteness of the quantum formalism is likely to show up in cases where the formalism contradicts local realism. This is again the EPR argument, but with the synechistic concept of local realism there is no need to look for hidden variables as a more basic description of reality. On the contrary: The application of Peirce's theory of semiotics in connection with the energy bond formalism of Paynter points to the applicability of the quantum formalism in cases where the necessary physical sign relations are preset by the measuring apparatus. There seems to be a hidden logic of good experimentalism that normally ensures the validity of the quantum formalism and quantum semiotics is an attempt to reveal this logic by pointing to the importance of preset connecting bonds. If the necessary connections are absent or weak a coarse graining procedure must be used instead of predictions based on the collapse of the pure state. In the case of two-particle spin- or polarization correlation experiment the coarse graining needed in the absence of preset connections to a coincidence counter will lead to the applicability of Bell's inequalities.

Acknowledgements.

The author wishes to express his gratitude for many discussions on the philosophical questions of the EPR paradox with E. Klug Andersen, M. Asmussen, Helmuth Hansen, E. Brun Hansen, and the late R. D. Mattuck. Thanks for useful critique and comments to the present paper are due to T. Juul Andersen, S. Brier, J. P. Christensen, J. Gundermann and J. Jensen.

APPENDIX

Simulation of discrete noise.

The fluctuation-dissipation theorem (8) gives by Fourier-transformation (Wiener-Khinchin theorem)

$$\langle e(t')e(t'+t) \rangle_T = \int_0^\infty P_e^T(\omega) \cos \omega t d\omega = \frac{\hbar}{\pi} \int_0^\infty Z_1(\omega) \cdot \omega \coth \frac{\hbar\omega}{2kT} \cdot \cos \omega t d\omega \quad (A1)$$

We now introduce the phase variable ϕ by the definition

$$\phi(t) = \frac{1}{\hbar} \int_0^t e(t') dt' \quad (A2)$$

This variable will perform a diffusive motion with the width function

$$\begin{aligned} \langle \phi(t)^2 \rangle_T &= \frac{1}{\hbar^2} \int_0^t dt' \int_0^t dt'' \langle e(t')e(t'') \rangle_T \\ &= \frac{2}{\pi\hbar} \int_0^\infty Z_1(\omega) \coth \frac{\hbar\omega}{2kT} \cdot \frac{1 - \cos \omega t}{\omega} d\omega \end{aligned} \quad (A3)$$

For shot noise of the type (13) we find that the average number of events from time 0 to t is given by the width function divided by $4\pi^2$, i.e.

$$N(t) = \frac{1}{\pi^2 \hbar} \int_0^\infty Z_1(\omega) \coth \frac{\hbar\omega}{2kT} \cdot \frac{1 - \cos \omega t}{\omega} d\omega \quad (A4)$$

so, for $T = 0$ when we use (6) for $Z_1(\omega)$ we get eq. (17). and for arbitrary T we have

$$N(t) = \rho \int_0^\infty \frac{1 - \cos \omega t}{\omega(1 + \omega^2 \tau_i^2)} \coth \frac{\hbar\omega}{2kT} d\omega \quad (A5)$$

with $\rho = \frac{R}{\pi^2 \hbar}$.

For general time-homogeneous shot noise the connections between $N(t)$ and the family of waiting time distributions $P_n(t)$ are given by eq.s (21) - (23).

By transforming these equations with the Laplace transform (24) we get

$$\begin{aligned}\tilde{N}(s) &= \sum_{n=0}^{\infty} n \tilde{P}_n(s) \\ \tilde{P}_n(s) &= \tilde{p}_1(s) \tilde{P}_{n-1}(s) \\ \tilde{p}_1(s) &= 1 - s \tilde{P}_0(s)\end{aligned}\tag{A6}$$

and accordingly

$$\tilde{P}_n(s) = [1 - s \tilde{P}_0(s)]^n \tilde{P}_0(s)\tag{A7}$$

$$\tilde{N}(s) = \tilde{P}_0(s) \sum_{n=0}^{\infty} n \cdot [1 - s \tilde{P}_0(s)]^n = \frac{1 - s \tilde{P}_0(s)}{s^2 \tilde{P}_0(s)}\tag{A8}$$

Solving eq. (A8) for $\tilde{P}_0(s)$ we get

$$\tilde{P}_0(s) = \frac{1}{s[s\tilde{N}(s) + 1]}\tag{A9}$$

Let us first consider the classical limit

$$kT \gg \hbar/\tau_i, \quad t \gg \tau_i\tag{A10}$$

where we get from (A5)

$$N(t) = \frac{2RkT}{\hbar^2} \cdot t = t/\tau_c\tag{A11}$$

showing that this is a markoffian process with the time-independent intensity $1/\tau_c$. Laplace transformation gives

$$N(s) = 1/(s^2 \tau_c), \text{ so, by (A9): } \tilde{P}_0(s) = \frac{\tau_c}{1 + s\tau_c}$$

and by inverse Laplace transformation

$$P_0(t) = \frac{1}{2\pi i} \int_{\Sigma - i\infty}^{\Sigma + i\infty} \tilde{P}_0(s) e^{st} ds = e^{-t/\tau_c} \quad (\text{A12})$$

The other distributions $P_n(t)$ are found to be the gamma distributions characterizing the ordinary Poisson process. This is all very well known and should just illustrate that the general formalism based on (A5) and (A9) works in the classical limit but that the result (A12) never approaches a constant finite value and therefore cannot reproduce the quantum mechanical probability for the qualitative jump.

For the zero point noise we can determine $N(t)$ directly from eq. (17) and find it analytically expressed by exponential integrals

$$\frac{1}{\rho} N(t) = \frac{1}{2} [e^{t/\tau_i} E_1(t/\tau_i) - e^{-t/\tau_i} Ei(t/\tau_i)] + \gamma + \ln \frac{t}{\tau_i} \quad (\text{A13})$$

where γ is Euler's constant. In the two limits $t \ll \tau_i$ and $t \gg \tau_i$ we have

$$N(t) = \begin{cases} \frac{\rho}{2} \frac{t^2}{\tau_i^2} \left(\frac{3}{2} - \gamma - \ln \frac{t}{\tau_i} \right) & \text{for } t \ll \tau_i \\ \rho \left(\gamma + \ln \frac{t}{\tau_i} \right) = \rho \ln \frac{t}{\tau_i} & \text{for } t \gg \tau_i \end{cases} \quad (\text{A14})$$

By Laplace transformation of eq. (17) we find

$$\tilde{N}(s) = \rho \cdot \frac{\ln \frac{1}{s\tau_i}}{s \cdot (1 - s^2\tau_i^2)} \quad (\text{A15})$$

and hence, from (A9)

$$\tilde{P}_0(s) = \left[s \left(\rho \frac{\ln \frac{1}{s\tau_i}}{1 - s^2\tau_i^2} + 1 \right) \right]^{-1} \quad (\text{A16})$$

When using this expression in the inverse Laplace transform (A12) we let be an infinitesimal positive quantity, i.e. $s = -i\omega + 0+$, and

$$\ln \frac{1}{s\tau_i} = \ln \frac{1}{|\omega\tau_i|} + i \frac{\pi}{2} \text{sign}(\omega)$$

so that $P_0(t)$ can be calculated by the real integral

$$P_0(t) = \int_0^{\infty} \frac{(1 + \omega^2 \tau_i^2) \left[\frac{\rho}{2} \cos \omega t + \frac{1}{\pi} (\rho \ln \frac{1}{\omega\tau_i} + 1 + \omega^2 \tau_i^2) \sin \omega t \right]}{\omega \left[(\rho \ln \frac{1}{\omega\tau_i} + 1 + \omega^2 \tau_i^2)^2 + \frac{\pi^2}{4} \rho^2 \right]} d\omega \quad (\text{A17})$$

which can be determined numerically for all values of ρ . It will always decrease monotonically from $P_0(0) = 1$ to $P_0(\infty) = 0$.

As shown in sec. 6 the ideal case is characterized by a small value of ρ of the order $1/\ln(\tau_M/\tau_i)$ because $N(t)$ shall have nearly constant value of the order unity when t is of the order $\tau_M \gg \tau_i$. We can estimate ρ in the following way: The microtime τ_i is about h/E where $E \approx 1\text{eV}$ is a suitable activation energy, i.e. $\tau_i \approx 10^{-15}$ s. Putting $\tau_M \approx 10^{-9}$ s we find

$$\rho \lesssim 0.1 \quad (\text{A18})$$

For such small values, $P_0(t)$ will be nearly constant in a large interval around τ_M .

In order to find $P_0(t)$ in the appropriate limit we put

$$\rho = \frac{q}{\ln \frac{\tau_M}{\tau_i}} \quad (\text{A19})$$

so, by letting $\tau_M \rightarrow \infty$ for fixed q and τ_i we find: $P_0(t) = C(\xi) + S(\xi)$ where $\xi = t/\tau_M$ and $C(\xi)$ and $S(\xi)$ are respectively the cosine- and the sine-part of the integral (A17)

$$S(\xi) \approx \frac{1}{\pi(1+q)} \int_0^{\infty} \frac{\sin u\xi}{u} du = \frac{1}{2(1+q)}$$

$$C(\xi) \approx \frac{\rho}{2} \int_0^1 \frac{du}{u(1+q+\rho \ln \frac{1}{u})^2} \approx \frac{1}{2} \int_0^{\infty} \frac{dz}{(1+q+z)^2} = \frac{1}{2(1+q)}$$

$$\text{i.e. } P_0(t) \approx \frac{1}{1+q}$$

This approximation can also be used in the limit $t \gg \tau_i$ if we, instead of defining q by (A19) use the slowly time-dependent function $q = N(t)$, so

$$P_0(t) \approx \frac{1}{1+N(t)} \tag{A20}$$

and for the other distributions $P_n(t)$ we find

$$P_n(t) = \frac{1}{1+N(t)} \cdot \left[\frac{N(t)}{1+N(t)} \right]^n$$

showing that in this limit we have a geometric distribution for the number of events, quite different from the Poisson distribution in the classical limit.

For the case $\rho = 1$ the integral (A17) has been evaluated numerically. The following interpolation formula gives the result to 4 decimals ($x = t/\tau_i$):

$$P_0 = \begin{cases} \exp \left\{ -x^{1.75} (-0.0276x^3 + 0.1858x^2 - 0.5375x + 0.9598) \right\} & \text{for } 0 \leq x \leq 1 \\ 2.2088x^{-5} - 7.3107x^{-4} + 8.2578x^{-3} - 3.4264x^{-2} + 0.6146x^{-1} + 0.2155 & \text{for } 1 < x \leq 5 \\ (\ln x + 3.9256x^{-3/2} - 3.0034x^{-1} + 1.7651x^{-1/2} + 1.7511)^{-1} & \text{for } x > 5 \end{cases}$$

The interpolation formula can easily be inverted on a programmable calculator and the stochastic process can then be simulated in the following way:

- a) We choose an $x = t/\tau_i$ and calculate $u = P_0(x)$.
- b) We generate a random number v with a uniform distribution between 0 and 1.
- c) If $v < u$ the number of events is zero (simulation over).
- d) If $v > u$ we determine $x_1 = P_0^{-1}(v)$, and x_1 is then the time of the first event.
- e) We then go back to a) using x_1 as the new origin of time and $x - x_1$ as the new value of x . This procedure continues summing the number of events until it ends in point c).

The following table gives results for 100 simulations with $x = 10$ ($\rho = 1$).

no. of events:	0	1	2	3	4	5	6	7	8	9
no. of simulations:	28	16	13	11	10	8	5	6	2	1

Average: $\langle n \rangle = 2.52$ (theory $N(10) = 2.5363$). Std. dev. $\sigma_n = 2.41$.

The fact that the standard deviation σ_n is nearly equal to the mean value $\langle n \rangle$ indicates a geometric process. So, we see that even though $\rho = 1$ is not a particularly small value we find a nearly geometric distribution for the number of events.

Notes and references.

1. A. Einstein, B. Podolsky, and Rosen, Phys. Rev. 47, 777 (1935)
2. J. S. Bell, Physics 1, 195 (1965)
3. The following review article gives a thorough discussion of the experimental implementation of Bell's theory:
J. F. Clauser and A. Shimony, Rep. Prog. Phys. 41, 1981 (1978).
- 4.a A. Aspect, P. Grangier, and G. Roger, Phys. Rev. Lett. 47, 460 (1981)
b A. Aspect, P. Grangier, and G. Roger, Phys. Rev. Lett. 49, 91 (1982)
c A. Aspect, J. Dalibard, and G. Roger, Phys. Rev. Lett. 49, 1804 (1982).
The whole series of Orsay experiments is described in:
d A. Aspect and P. Grangier, Proc. Int. Symp. Foundations of quantum mechanics, Tokyo, 1983, pp 214 - 224.
5. N. Bohr, Phys. Rev. 48, 696 (1935).
6. See for example: R. C. Lyndon, "Notes on Logic". D. van Nostrand, Princeton 1966.
7. L. Rosenfeld who acted as a secretary and discussion partner for Bohr has told the following story of the reaction to the EPR-article in the memorial volume "Niels Bohr" (1964). (My translation from danish).

"As soon as Bohr had heard my account of Einstein's argument everything else was put aside: we had to clear up such a misunderstanding at once. We should answer by going through the same example and demonstrate the correct way of speaking about it. Very anxious Bohr immediately began to dictate me a sketch for such an answer, but soon he became hesitant: "No, this will not work. We'll have to try once more from scratch ... We'll have to make it totally clear ...". In this way we continued for some time increasingly puzzled by the unexpected sophistication of the argument. Now and then he turned to me: "What can they mean? Do you understand it?" Some rather unconvincing attempts of interpretation followed. Evidently we were farther from the goal than we had first believed. Finally Bohr stopped with the well known remark that he "had to sleep on it". The next morning he continued the dictation immediately and it struck me that there was a change in the sound of sentences. Yesterday's sharp expression of disagreement had vanished. As I remarked to Bohr that he now seemed to consider the case more mildly he smiled: "That is just a sign," he said, "that we are beginning to understand the problem". And really, now the serious work began. Day after day, week after week the whole ar-

gumentation was patiently investigated by means of simpler and more transparent examples. Einstein's problem was reshaped and its solution formulated again with such precision and clarity that the weakness in the reasoning of the critics became evident, and their whole argumentation, in spite of all its fake spirituality, was shattered to pieces. "They do it nicely," was Bohr's comment, "but what counts is to do it correctly".

8. Compare, for example, the following two papers by T. W. Marshall, before and after the "switching" experiment by Aspect, Dalibard, and Roger ^{4c.}:

a T. W. Marshall, Phys. Lett. 75A, 265 (1980)

(with the title "The Aspect experiment and the return to reality", comp. sec. 8. of this paper. Marshall writes here about the role of the zero point vacuum fluctuations).

b T. W. Marshall, E. Santos and F Selleri, Phys. Lett. 98A, 5 (1983).

(Here the critique is directed against the "no enhancement" hypothesis of Clauser and Horne ^{17.}).

9. N. D. Mermin, Am. J. Phys. 49, 940 (1981).

10. A good introduction to Peirce's philosophy can be found in the following 5 papers he wrote to "The Monist", 1891 - 93:

a C. S. Peirce, The Monist I, 161 (1891).

b - - - - - , ibid. II, 321 (1892)

c - - - - - , ibid. II, 534 (1892)

d - - - - - , ibid. III, 1 (1893)

e - - - - - , ibid. III, 176 (1893).

Abbreviated versions of these papers can be found in:

f J. Buchler (ed.) "Philosophical writings of Peirce", Dover, N.Y. (1955).

Other sides of Peirce's work in: (Pragmatism, semiotics, etc.)

g "Collected Papers, C. S. Peirce", vol. I - VIII. Ed. Charles Hartshorne and Paul Weiss, The Belknap Press of Harvard University Press, Cambridge Mass. (1969).

11. In "The Conceptual Development of Quantum Mechanics" Max Jammer points out Bohr's interest in Kierkegaard's philosophy and certain conceptual parallels, in particular between Kierkegaard's qualitative jump and Bohr's irreducible quantum jumps. One can also find strong parallels in the dialectical approach to teaching (e.g. Bohr's famous remark about the complementarity between truth and clarity). The whole viewpoint that Bohr should have been influenced from Kierkegaard is criticized in the following article:

- a D. Favrhøldt, Danish Yearbook of Philosophy, 13, 206 (1976).
Another paper points out that the philosophical teacher of Bohr in his youth, H. Høffding, although an expert in Kierkegaard's philosophy, was more inspired by the continuity thinking of Leibniz than by Kierkegaard's jump, and that the continuity concept is important in Bohr's correspondence principle:
- b J. Witt-Hansen, Danish Yearbook of Philosophy, 17, 31 (1980).
- 12.a H. M. Paynter, "Analysis and Design of Engineering Systems", M.I.T. Class Notes (1961).
A more recent textbook treatment of Paynter's formalism and its applications in physics and engineering, but without reference to Peirce's philosophy, can be found in:
- b D. Karnopp and R. C. Rosenberg, "System Dynamics: A Unified Approach", Michigan State University, (1971).
13. H. B. Callen and T. A. Welton, Phys. Rev. 83, 34 (1951).
14. I. R. Senitzky, Phys. Rev. 119, 670 (1960).
15. G. Kron, "Tensor Analysis of Networks", Mc Donald, London (1939,1965).
16. Proceedings of the International School of Physics "Enrico Fermi", Foundations of quantum Mechanics, Academic Press, N.Y. (1971).
17. A. Daneri, A. Loinger and C. M. Prospero, Nuclear Physics 33, 297 (1962).
18. There is a simple synechistic explanation for the importance of this device: If we consider a cascade coupling of identical two ports with the same structure but without the restriction that the gyrator and the conductance shall have the same magnitude (gyrator g , conductance g') then the limiting behavior of an infinite number of such cascaded devices will be described exactly by the model of fig. 10, irrespective of the value of the conductance g' .
- 19.a E. C. Kemble, Phys. Rev. 47, 973 (1935).
b I. E. Ballentine, Revs. Mod. Phys. 42, 358 (1970).
20. D. Bohm, "Quantum Theory", Prentice Hall, N.Y. (1951).
21. A. Aspect, Phys. Rev. D14, 1944 (1976).
22. S. J. Freedman and J. F. Clauser, Phys. Rev. Lett. 28, 938 (1972).
23. J. F. Clauser and M. A. Horne, Phys. Rev. D10, 526 (1974).
24. E. Santos, Phys. Lett. 101A, 379 (1984).

25. An account of the Furry-hypothesis in connection with Bell's inequalities can be found in:
A. Baracca, D. J. Bohm, B. J. Hiley and A. E. G. Stuart, *Nuov. Cim.* 28B, 453 (1975).
26. W. Bothe und H. Geiger, *Zeitschr. f. Physik*, 32, 44 (1925).
27. G. Faraci, D. Gutkowski, S. Notarrigo and A. R. Pennisi, *Lett. Nuov. Cim.* 9, 607 (1974).

- 1/78 "TANKER OM EN PRAKSIS" - et matematikprojekt.
Projekt rapport af Anne Jensen, Lena Lindenskov, Marianne Kesselhahn og Nicolai Lomholt.
Vejleder: Anders Madsen.
- 2/78 "OPTIMERING" - Menneskets forøgede beherskelsesmuligheder af natur og samfund.
Projekt rapport af Tom J. Andersen, Tommy R. Andersen, Gert Kreinøe og Peter H. Lassen.
Vejleder: Bernhelm Booss.
- 3/78 "OPGAVESAMLING", breddekursus i fysik. Nr. 3 er a jour ført i marts 1984
Lasse Rasmussen, Aage Bonde Kræmmer, Jens Højgaard Jensen.
- 4/78 "TRE ESSAYS" - om matematikundervisning, matematiklæreruddannelsen og videnskabsrindalismen. Nr. 4 er p.t. udgået.
Mogens Niss.
- 5/78 "BIBLIOGRAFISK VEJLEDNING til studiet af DEN MODERNE FYSIKS HISTORIE". Nr. 5 er p.t. udgået.
Helge Kragh.
- 6/78 "NOGLE ARTIKLER OG DEBATINDLÆG OM - læreruddannelse og undervisning i fysik, og - de naturvidenskabelige fags situation efter studenteroprøret".
Karin Beyer, Jens Højgaard Jensen og Bent C. Jørgensen.
- 7/78 "MATEMATIKKENS FORHOLD TIL SAMFUNDSØKONOMIEN". Nr. 7 er udgået.
B.V. Gnedenko.
- 8/78 "DYNAMIK OG DIAGRAMMER". Introduktion til energy-bond-graph formalismen.
Peder Voetmann Christiansen.
- 9/78 "OM PRAKSIS' INDFLYDELSE PÅ MATEMATIKKENS UDVIKLING". - Motiver til Kepler's: "Nova Stereometria Doliorum Vinariorum".
Projekt rapport af Lasse Rasmussen.
Vejleder: Anders Madsen.
-
- 10/79 "TERMODYNAMIK I GYMNASIET".
Projekt rapport af Jan Christensen og Jeanne Mortensen.
Vejledere: Karin Beyer og Peder Voetmann Christiansen.
- 11/79 "STATISTISKE MATERIALER"
red. Jørgen Larsen
- 12/79 "LINEÆRE DIFFERENTIALLIGNINGER OG DIFFERENTIALLIGNINGSSYSTEMER". Nr. 12 er udgået
Mogens Brun Heefelt
- 13/79 "CAVENDISH'S FORSØG I GYMNASIET".
Projekt rapport af Gert Kreinøe.
Vejleder: Albert Chr. Paulsen

- 14/79 "BOOKS ABOUT MATHEMATICS: History, Philosophy, Education, Models, System Theory, and Works of Reference etc. A Bibliography".
Else Høyrup. Nr. 14 er p.t. udgået.
- 15/79 "STRUKTUREL STABILITET OG KATASTROFER i systemer i og udenfor termodynamisk ligevægt".
Specialeopgave af Leif S. Striegler.
Vejleder: Peder Voetmann Christiansen.
- 16/79 "STATISTIK I KRÆFTFORSKNINGEN".
Projektrapport af Michael Olsen og Jørn Jensen.
Vejleder: Jørgen Larsen.
- 17/79 "AT SPØRGE OG AT SVARE i fysikundervisningen".
Albert Christian Paulsen.
- 18/79 "MATHEMATICS AND THE REAL WORLD", Proceedings of an International Workshop, Roskilde University Centre, Denmark, 1978. Preprint.
Bernhelm Booss & Mogens Niss (eds.).
- 19/79 "GEOMETRI, SKOLE OG VIRKELIGHED".
Projektrapport af Tom J. Andersen, Tommy R. Andersen og Per H.H. Larsen.
Vejleder: Mogens Niss.
- 20/79 "STATISTISKE MODELLER TIL BESTEMMELSE AF SIKRE DOSER FOR CARCINOGENE STOFFER".
Projektrapport af Michael Olsen og Jørn Jensen.
Vejleder: Jørgen Larsen.
- 21/79 "KONTROL I GYMNASIET - FORMAL OG KONSEKVENSER".
Projektrapport af Crilles Bacher, Per S. Jensen, Preben Jensen og Torben Nysteen.
- 22/79 "SEMIOTIK OG SYSTEMEGENSKABER (1)".
1-port lineært response og støj i fysikken.
Peder Voetmann Christiansen.
- 23/79 "ON THE HISTORY OF EARLY WAVE MECHANICS - with special emphasis on the role of reality".
-
- 24/80 "MATEMATIKOPFATTELSE HOS 2.G'ERE".
a+b 1. En analyse. 2. Interviewmateriale. Nr. 24 a+b er p.t. udgået.
Projektrapport af Jan Christensen og Knud Lindhardt Rasmussen.
Vejleder: Mogens Niss.
- 25/80 "EKSAMENSOPGAVER", Dybdemodulet/fysik 1974-79.
- 26/80 "OM MATEMATISKE MODELLER".
En projektrapport og to artikler.
Jens Højgaard Jensen m.fl.
- 27/80 "METHODOLOGY AND PHILOSOPHY OF SCIENCE IN PAUL DIRAC'S PHYSICS".
Helge Kragh.
- 28/80 "DIELEKTRISK RELAXATION - et forslag til en ny model bygget på væskernes viscoelastiske egenskaber".
Projektrapport, speciale i fysik, af Gert Kreinøe.
Vejleder: Niels Boye Olsen.

- 29/80 "ODIN - undervisningsmateriale til et kursus i differentiallyigningsmodeller".
 Projekt rapport af Tommy R. Andersen, Per H.H. Larsen og Peter H. Lassen.
 Vejleder: Mogens Brun Heefelt
- 30/80 "FUSIONSENERGIEN - - - ATOMSAMFUNDETS ENDESTATION".
 Oluf Danielsen. Nr. 30 er udgået.
 Udkommer medio 1982 på Fysik-, Matematik- og Kemilærer-
 nes forlag.
- 31/80 "VIDENSKABSTEORETISKE PROBLEMER VED UNDERVISNINGSSY-
 STEMER BASERET PÅ MÆNGDELÆRE". Nr. 31 er p.t. udgået
 Projekt rapport af Troels Lange og Jørgen Karrebæk.
 Vejleder: Stig Andur Pedersen.
- 32/80 "POLYMERE STOFFERS VISCOELASTISKE EGENSKABER - BELYST
 VED HJÆLP AF MEKANISKE IMPEDANSMALINGER OG MOSSBAUER-
 EFFEKTMALINGER".
 Projekt rapport, speciale i fysik, af Crilles Bacher og
 Preben Jensen.
 Vejledere: Niels Boye Olsen og Peder Voetmann Chri-
 stiansen.
- 33/80 "KONSTITUERING AF FAG INDEN FOR TEKNISK-NATURVIDENSKA-
 BELIGE UDDANNELSER. I-II".
 Arne Jakobsen.
- 34/80 "ENVIRONMENTAL IMPACT OF WIND ENERGY UTILIZATION".
 ENERGY SERIES NO.1. Nr. 34 er udgået.
 Bent Sørensen. Publ. i "Renewable Sources of Energy and the Environment",
 Tycooli International Press, Dublin, 1981.
- 35/80 "HISTORISKE STUDIER I DEN NYERE ATOMFYSIKS UDVIKLING".
 Helge Kragh.
- 36/80 "HVAD ER MENINGEN MED MATEMATIKUNDERVISNINGEN ?".
 Fire artikler.
 Mogens Niss.
- 37/80 "RENEWABLE ENERGY AND ENERGY STORAGE".
 ENERGY SERIES NO.2.
 Bent Sørensen.
-
- 38/81 "TIL EN HISTORIETEORI OM NATURERKENDELSE, TEKNOLOGI
 OG SAMFUND". Nr. 38 er p.t. udgået
 Projekt rapport af Erik Gade, Hans Hedal, Henrik Lau
 og Finn Physant.
 Vejledere: Stig Andur Pedersen, Helge Kragh og
 Ib Thiersen.
- 39/81 "TIL KRITIKKEN AF VÆKSTØKONOMIEN".
 Jens Højgaard Jensen.
- 40/81 "TELEKOMMUNIKATION I DANMARK - oplæg til en teknolo-
 givurdering". Nr. 40 er p.t. udgået
 Projekt rapport af Arne Jørgensen, Bruno Petersen og
 Jan Vedde.
 Vejleder: Per Nørgaard.
- 41/81 "PLANNING AND POLICY CONSIDERATIONS RELATED TO THE
 INTRODUCTION OF RENEWABLE ENERGY SOURCES INTO ENERGY
 SUPPLY SYSTEMS".
 ENERGY SERIES NO.3.
 Bent Sørensen.

- 42/81 "VIDENSKAB TEORI SAMFUND - En introduktion til materialistiske videnskabsopfattelser".
Helge Kragh og Stig Andur Pedersen.
- 43/81 1. "COMPARATIVE RISK ASSESSMENT OF TOTAL ENERGY SYSTEMS".
2. "ADVANTAGES AND DISADVANTAGES OF DECENTRALIZATION".
ENERGY SERIES NO.4.
Bent Sørensen.
- 44/81 "HISTORISK UNDERSØGELSE AF DE EKSPERIMENTELLE FORUDSÆTNINGER FOR RUTHERFORDS ATOMMODEL".
Projektrapport af Niels Thor Nielsen.
Vejleder: Bent C. Jørgensen.
-
- 45/82
- 46/82 "EKSEMPLARISK UNDERVISNING OG FYSISK ERKENDELSE - I+II ILLUSTRERET VED TO EKSEMPLER".
Projektrapport af Torben O. Olsen, Lasse Rasmussen og Niels Dreyer Sørensen.
Vejleder: Bent C. Jørgensen.
- 47/82 "BARSEBACK OG DET VÆRST OFFICIELT-TÆNKELIGE UHELD".
ENERGY SERIES NO.5.
Bent Sørensen.
- 48/82 "EN UNDERSØGELSE AF MATEMATIKUNDERVISNINGEN PÅ ADGANGSKURSUS TIL KØBENHAVNS TEKNIKUM".
Projektrapport af Lis Eilertzen, Jørgen Karrebæk, Troels Lange, Preben Nørregaard, Lissi Pedersen, Laust Rishøj, Lill Røn, Isac Showiki.
Vejleder: Mogens Niss.
- 49/82 "ANALYSE AF MULTISPEKTRALE SATELLITBILLEDER".
Projektrapport af Preben Nørregaard.
Vejledere: Jørgen Larsen & Rasmus Ole Rasmussen.
- 50/82 "HERSLEV - MULIGHEDER FOR VEDVARENDE ENERGI I EN LANDSBY". ENERGY SERIES NO.6.
Rapport af Bent Christensen, Bent Hove Jensen, Dennis B. Møller, Bjarne Laursen, Bjarne Lillethorup og Jacob Mørch Pedersen.
Vejleder: Bent Sørensen.
- 51/82 "HVAD KAN DER GØRES FOR AT AFHJÆLPE PIGERS BLOKERING OVERFOR MATEMATIK?"
Projektrapport af Lis Eilertzen, Lissi Pedersen, Lill Røn og Susanne Stender.
- 52/82 "DESUSPENSION OF SPLITTING ELLIPTIC SYMBOLS"
Bernhelm Booss & Krzysztof Wojciechowski.
- 53/82 "THE CONSTITUTION OF SUBJECTS IN ENGINEERING EDUCATION".
Arne Jakobsen & Stig Andur Pedersen.
- 54/82 "FUTURES RESEARCH" - A Philosophical Analysis of Its Subject-Matter and Methods.
Stig Andur Pedersen & Johannes Witt-Hansen.

- 55/82 "MATEMATISKE MODELLER" - Litteratur på Roskilde
Universitetsbibliotek. Vedr. tekst nr. 55/82:
En bibliografi. Se også tekst 62/83.
Else Høyrup.
- 56/82 "ÉN - TO - MANGE" -
En undersøgelse af matematisk økologi.
Projektrapport af Troels Lange.
Vejleder: Anders Madsen.
-
- 57/83 "ASPECT EKSPERIMENTET" - Nr. 57 er udgået.
Skjulte variable i kvantemekanikken?
Projektrapport af Tom Juul Andersen.
Vejleder: Peder Voetmann Christiansen.
- 58/83 "MATEMATISKE VANDRINGER" - Modelbetragtninger
over spredning af dyr mellem småbiotoper i
agerlandet.
Projektrapport af Per Hammershøj Jensen &
Lene Vagn Rasmussen.
Vejleder: Jørgen Larsen.
- 59/83 "THE METHODOLOGY OF ENERGY PLANNING".
ENERGY SERIES NO. 7.
Bent Sørensen.
- 60/83 "MATEMATISK MODEKSPERTISE" - et eksempel.
Projektrapport af Erik O. Gade, Jørgen Karrebæk og
Preben Nørregaard.
Vejleder: Anders Madsen.
- 61/83 "FYSIKS IDEOLOGISKE FUNKTION", som et eksempel på
en naturvidenskab - historisk set.
Projektrapport af Annette Post Nielsen.
Vejledere: Jens Høyrup, Jens Højgaard Jensen og
Jørgen Vogelius.
- 62/83 "MATEMATISKE MODELLER" - Litteratur på Roskilde
Universitetsbibliotek.
En bibliografi. 2. rev. udgave
Else Høyrup
- 63/83 "CREATING ENERGY FUTURES: A SHORT GUIDE TO
ENERGY PLANNING".
ENERGY SERIES No. 8
David Crossley & Bent Sørensen
- 64/83 "VON MATHEMATIK UND KRIEG".
Bernhelm Booss og Jens Høyrup
- 65/83 "ANVENDT MATEMATIK - TEORI ELLER PRAKSIS".
Projektrapport af Per Hedegård Andersen, Kirsten
Habekost, Carsten Holst-Jensen, Annelise von Moos,
Else Marie Pedersen, Erling Møller Pedersen.
Vejledere: Bernhelm Booss & Klaus Grünbaum
- 66/83 "MATEMATISKE MODELLER FOR PERIODISK SELEKTION I
ESCHERICHIA COLI".
Projektrapport af Hanne Lisbet Andersen, Ole
Richard Jensen og Klavs Frisdahl.
Vejledere: Jørgen Larsen og Anders Hede Madsen

- 67/83 "ELIPSOIDE METODEN - EN NY METODE TIL LINEÆR PROGRAMMERING?"
Projektrapport af Lone Biilmann og Lars Boye
Vejleder: Mogens Brun Heefelt
- 68/83 "STOKASTISKE MODELLER I POPULATIONSGENETIK"
- til kritikken af teoriladede modeller.
Projektrapport af Lise Odegård Gade, Susanne Hansen, Michael Hviid, Frank Mølgård Olsen.
Vejleder: Jørgen Larsen.
- 69/83 "ELEVFORUDSÆTNINGER I FYSIK"
- en test i l.g med kommentarer
Albert Chr. Paulsen
- 70/83 "INDLÆRINGS- OG FORMIDLINGSPROBLEMER I MATEMATIK PÅ VOKSENDERVISNINGSNIVEAU"
Projektrapport af Hanne Lisbet Andersen, Torben J. Andreasen, Svend Åge Houmann, Helle Glerup Jensen, Keld Fl. Nielsen, Lene Vagn Rasmussen.
Vejleder: Klaus Grünbaum & Anders H. Madsen
- 71/83 "PIGER OG FYSIK"
- et problem og en udfordring for skolen?
Karin Beyer, Sussanne Blegaa, Birthe Olsen, Jette Reich & Mette Vedelsby
- 72/83 "VERDEN IFØLGE PEIRCE" - to metafysiske essays, om og af C.S. Peirce.
Peder Voetmann Christiansen
- 73/83 "EN ENERGIANALYSE AF LANDBRUG"
- økologisk contra traditionelt
ENERGY SERIES No. 9
Specialeopgave i fysik af
Bent Hove Jensen
Vejleder: Bent Sørensen
-
- 74/84 "MINIATURISERING AF MIKROELEKTRONIK" - om videnskabeliggjort teknologi og nytten af at lære fysik
Projektrapport af Bodil Harder og Linda Szko-
tak Jensen.
Vejledere: Jens Højgaard Jensen og Bent C.
Jørgensen
- 75/84 "MATEMATIKUNDERVISNINGEN I FREMTIDENS GYMNASIUM"
- Case: Lineær programmering
Projektrapport af Morten Blomhøj, Klavs Frisdahl, Frank Mølgård Olsen
Vejledere: Mogens Brun Heefelt & Jens Bjørneboe
- 76/84 "KERNEKRAFT I DANMARK?" - Et høringssvar indkaldt af miljøministeriet, med kritik af miljøstyrelsens rapporter af 15. marts 1984.
ENERGY SERIES No. 10
Af Niels Boye Olsen og Bent Sørensen
- 77/84 "POLITISKE INDEKS - FUP ELLER FAKTA?"
Opinionsundersøgelser belyst ved statistiske modeller
Projektrapport af Svend Åge Houmann, Keld Nielsen, Susanne Stender
Vejledere: Jørgen Larsen & Jens Bjørneboe

- 78/84 "JÆVNSTRØMSLEDNINGSEVNE OG GITTERSTRUKTUR I AMORFT GERMANIUM"
Specialerapport af Hans Hedal, Frank C. Ludvigsen og Finn C. Physant
Vejleder: Niels Boye Olsen
- 79/84 "MATEMATIK OG ALMENDANNELSE"
Projektrapport af Henrik Coster, Mikael Wennerberg Johansen, Povl Kattler, Birgitte Lydholm og Morten Overgaard Nielsen.
Vejleder: Bernhelm Booss
- 80/84 "KURSUSMATERIALE TIL MATEMATIK B"
Mogens Brun Heefelt
- 81/84 "FREKVENSafhængig LEDNINGSEVNE I AMORFT GERMANIUM"
Specialerapport af Jørgen Wind Petersen og Jan Christensen
Vejleder: Niels Boye Olsen
- 82/84 "MATEMATIK- OG FYSIKUNDERVISNINGEN I DET AUTOMATISEREDE SAMFUND"
Rapport fra et seminar afholdt i Hvidovre 25-27 april 1983
Red.: Jens Højgaard Jensen, Bent C. Jørgensen og Mogens Niss
- 83/84 "ON THE QUANTIFICATION OF SECURITY"
PEACE RESEARCH SERIES NO. 1
af Bent Sørensen
- 84/84 " NOGLE ARTIKLER OM MATEMATIK, FYSIK OG ALMENDANNELSE".
Jens Højgaard Jensen, Mogens Niss m. fl.
- 85/84 "CENTRIFUGALREGULATORER OG MATEMATIK"
Specialerapport af Per Hedegård Andersen, Carsten Holst-Jensen, Else Marie Pedersen og Erling Møller Pedersen
Vejleder: Stig Andur Pedersen
- 86/84 "SECURITY IMPLICATIONS OF ALTERNATIVE DEFENSE OPTIONS FOR WESTERN EUROPE"
PEACE RESEARCH SERIES NO. 2
af Bent Sørensen
- 87/84 "A SIMPLE MODEL OF AC HOPPING CONDUCTIVITY IN DISORDERED SOLIDS"
af Jeppe C. Dyre
- 88/84 "RISE, FALL AND RESURRECTION OF INFINITESIMALS"
af Detlef Laugwitz
- 89/84 "FJERNVARMEOPTIMERING"
af Bjarne Lillethorup & Jacob Mørch Pedersen
- 90/84 "ENERGI I I.G- en teori for tilrettelæggelse"
af Albert Chr. Paulsen
- 91/85 "KVANTETEORI FOR GYMNASIET"
I. Lærervejledning
Projektrapport af: Birger Lundgren, Henning Sten Hansen og John Johansson
Vejleder: Torsten Meyer

92/85 "KVANTETEORI FOR GYMNASIET
2. Materiale

Projektrapport af: Birger Lundgren, Henning
Sten Hansen og John Johansson

Vejleder: Torsten Meyer

93/85 "THE SEMIOTICS OF QUANTUM-NON-LOCALITY"
af Peder Voetmann Christiansen

TEKST NR 138

1987

JOSEPHSON EFFECT AND CIRCLE MAP.

Paper presented at
The International Workshop on Teaching Nonlinear Phenomena
at Universities and Schools, "Chaos in Education".
Balaton, Hungary, 26 April - 2 May 1987.

By

Peder Voetmann Christiansen,
Institute of Mathematics and Physics,
Roskilde University Center,
P.O. box 260, DK 4000 Roskilde, Denmark.

TEKSTER fra

IMFUFA

ROSKILDE UNIVERSITETSCENTER
INSTITUT FOR STUDIET AF MATEMATIK OG FYSIK SAMT DERES
FUNKTIONER I UNDERVISNING, FORSKNING OG ANVENDELSER

JOSEPHSON EFFECT AND CIRCLE MAP.

Peder Voetmann Christiansen

IMFUFA Text no. 138/87

27 pages

ISSN 0106-6242

ABSTRACT.

The Josephson effects associated with a thin insulating layer or a narrow constriction between two superconductors has important technological applications and also provides an instructive example of non-linear effects that may be studied with relatively simple methods. The system is dynamically analogous to a damped pendulum driven by a constant and an oscillating torque and may be simulated by solving a non-linear second order differential equation. The phenomena of phase-locking and transition to chaos are, however, much more conveniently studied by the discrete circle-map.

This paper discusses the connection between the continuous time Josephson equation and the discrete circle-map by the method of return-maps. It will be shown that the so called critical circle map in many cases (but not all) is associated with the transition to hysteretic behaviour of the Josephson junction. The critical circle map, exhibiting a fractal mode-locking structure, is an example of the relevance of the mathematical theories of rational numbers to physics and is recommended as a good example of the challenges of experimental mathematics.

1. The Josephson equation

Superconductivity is one striking example of a macroscopic quantum phenomenon. A crude explanation for metallic superconductivity is obtained by the observation by Cooper (1956) that the effective interaction between electrons through lattice vibrations (phonons) is attractive for states near the Fermi surface, so it becomes energetically favorable to form pair-states, the so called Cooper pairs. These pairs have spin zero and act therefore like particles obeying Bose-Einstein statistics, like e.g. the atoms of He^4 , and similarly to liquid Helium the electrons will condense in a superfluid state at sufficiently low temperatures. This is an example of a Bose-condensation due to the "social" nature of Bose-particles who, quite unlike the "exclusive" Fermi particles, prefer to occupy the same quantum state.

The common wave function for the condensed Cooper-pairs thus acquires the status of a macroscopic order-parameter for the superconducting state, and all of the most striking phenomena of superconductivity, like perfect diamagnetism (Meissner effect), flux quantization, and persistent currents, can be related to the quantum mechanical nature of this complex, scalar field that is coupled to the electromagnetic vector-field. The combined thermodynamic and quantum-mechanical theory leading to non-linear partial differential equations for these two fields was discovered already in 1950 by Landau and Ginzburg¹, and this phenomenological theory has later been able to account for the Josephson effects².

In 1962 it was suggested by Brian D. Josephson that a thin insulating layer between two bulk superconductors should be able to carry a tunnelling supercurrent in the absence of any voltage. The magnitude of this current is given by the dc-equation

$$I_s = I_c \cdot \sin\phi \quad (1)$$

where I_c is the critical current and ϕ is the phase difference between the superconducting wave functions on the two sides of the barrier. In the presence of a voltage difference, V , over the barrier, the phase difference will increase linearly with time in accordance with the ac-equation

$$d\phi/dt = 2eV/\hbar \quad (2)$$

where e is the numerical charge of the electron (thus, the charge of a Cooper-pair is $-2e$) and $\hbar = h/2\pi$, h being Planck's quantum of action. Eq.s (1) and (2) together show that a constant dc-voltage over the junction will produce an ac-supercurrent with vanishing mean value.

In practice, however, it is not easy to control the voltage across the junction. The experimental situation is one of current-control, because the resistance of the junction is much smaller than the resistance in the external wires. The junction-resistance is due to the normal (i.e. not condensed) electrons, and this normal fluid is thus providing an extra channel for the current, parallel to the super-channel described by eq. (1). The normal current is given by Ohm's law:

$$I_n = V/R_n \quad (3)$$

where R_n is the normal resistance. Finally, if the junction has a non-vanishing capacitance, C , the following displacement-current must be added to the super- and the normal current:

$$I_d = C \cdot dV/dt \quad (4)$$

The resulting model, called the resistively and capacitively shunted Josephson junction, is very successful in explaining the observed current-voltage characteristics, when a Josephson junction is exposed to a microwave field. The effect of the microwaves is then described by an ac-current source, $I_{AC} \cdot \sin \omega t$, added to the dc-current, I_{DC} . The model in fig. 1a corresponds to the equation:

$$I_d + I_n + I_s = I_{DC} + I_{AC} \cdot \sin \omega t \quad (5)$$

This equation can be reduced to a dimensionless form in the following way. First, we measure the currents in units of the critical current, I_c , putting

$$I = I_{DC}/I_c \quad ; \quad A = I_{AC}/I_c \quad (6)$$

Next, we note that the super-channel, described by eq.s (1) and (2), for small values of the phase ϕ acts like a self-inductance

$$L_s = \hbar/(2eI_c), \quad (7)$$

so the ratio between this quantity and the normal resistance, $\tau = L_s/R_n$, can be used as a unit of time. Thus,

we introduce the symbols

$$\dot{\phi} = \tau \cdot d\phi/dt \quad ; \quad \ddot{\phi} = \tau^2 \cdot d^2\phi/dt^2 \quad ; \quad f = \tau \cdot \omega / 2\pi \quad (8)$$

and get the following second order differential equation:

$$Q^2 \cdot \ddot{\phi} + \dot{\phi} + \sin\phi = I + A \cdot \sin(2\pi f T) \quad (9)$$

where $T = t/\tau$, and Q is the dimensionless quantity

$$Q = R_n \cdot \sqrt{2eI_c C / \hbar} \quad (10)$$

As shown in fig. 1b the Josephson equation (9) may just as well describe a classical mechanical system: a damped and driven pendulum. The device may be constructed as metal disc with an excentric mass, M , and a friction unit, F , (e.g. a magnet). Through a torque-control unit, T , the experimenter should be able to apply a torque, consisting of a constant part superposed on a sinusoidally oscillating part, to the pendulum. The correspondence between the parameters and dynamic variables of the two analogous systems is shown in the table below.

<u>Josephson junction</u> .	<u>Pendulum</u> .
Phase ϕ	Angle from vertical
Supercurrent $I_s = I_c \sin\phi$	Torque from gravity
Normal current	Torque from friction
Capacitance C	Moment of inertia
Applied current $I_{DC} + I_{AC}$	Applied torque

In the following, however, we shall use "Josephson language", mainly because there is a wealth of experimental data to compare with for many different types of superconducting weak links. Before we go on to discuss such data we may remark the following on the different time scales in question. In addition to the inductive relaxation time τ , used as the time unit in eq. (9), and the period of oscillation τ/f of the ac-current (the microwave field), there are two other characteristic times. One is the capacitive relaxation time

$$R_n \cdot C = Q^2 \cdot \tau \quad (11)$$

and the other is the period of oscillation of the undamped "Josephson plasmon" or the undamped pendulum near the stable equilibrium in the absence of driving torques:

$$2\pi \cdot \sqrt{L_S \cdot C} = 2\pi Q \cdot \tau \quad (12)$$

The parameter Q is the quality factor for the plasmon-resonance; the motion will be oscillatory only for $Q > \frac{1}{2}$. A reason for using Q as the parameter instead of "the damping factor", $G = 1/Q$, is that it becomes easier to consider the case $Q = 0$, which is not a case of "infinite damping", but rather of vanishing capacitance. This case is particularly relevant for the case when the Josephson junction has the shape of a "Dayem-bridge", i.e. a narrow constriction in a thin superconducting film. The model in this case degenerates into "the resistively shunted junction", described by the first order differential equation (9) with $Q = 0$.

The experimental current-voltage characteristic with and without a microwave field present are sketched in fig. 2. (For a more detailed account, see ref. 3, and references therein). The figure applies to the cases $Q < \frac{1}{2}$; for greater values of Q the curves will exhibit hysteresis. The voltage measured is not the instantaneous value of V , but rather its mean value over a long period of time. A dimensionless measure of the voltage is the mean value of the phase derivative $\dot{\phi}$. This is related to the so called winding number, W , i.e. the average number of full turns of the phase per period of the ac-current (we always assume there is an ac-current with frequency f , even though its amplitude A may be zero):

$$W = \lim_{T \rightarrow \infty} \frac{\phi(T) - \phi(0)}{2\pi T \cdot f} = \frac{\langle \dot{\phi} \rangle}{2\pi f} \quad (13)$$

For $Q=0$, $A=0$ the IV-curve is a hyperbola approaching Ohm's law for the normal metal as I goes to infinity, but for $A>0$ there is a step in the current for every voltage that corresponds to an integral value $p/1$ of the winding number W . These are the so called harmonic steps, and their magnitude can be shown to go like the Bessel function J_p of the amplitude A . The supercurrent ($p=0$) should thus be reduced for $A>0$, but for real junctions there will often be an enhancement instead. This enhancement, the Dayem effect, is one of the few qualitative features that are not revealed by eq. (9) but must be explained by the microscopic theory⁴.

The subharmonic steps (not shown in fig. 2) for $W=p/q$, $q>1$, exist for all rational values of W and will be discussed in the following sections.

2. From continuous to discrete time .

The integration of the Josephson equation (9) is in principle straightforward, but very time consuming on a digital computer. A fast and reliable analog computer is the best tool, but this is very expensive, and the programming is rather intricate due to the presence of the $\sin\phi$. In this paper we discuss an alternative approach: the integration is done on an ordinary digital computer of a type that is common in high-schools and private homes (Amstrad 6128), but the results are presented graphically in a way that makes a transition to a discrete time model possible. Afterwards, the qualitative features of phase locking, bifurcations and chaos are investigated by the discrete model, the circle-map.

The method of integration is a 4th order Runge Kutta with variable step-length. When the four parameters Q , I , A and f have been chosen, the integration leads to a definite trajectory for every initial value of ϕ (in the interval from 0 to 2π) and $\dot{\phi}$. As the system is dissipative, the first part of the solution will be transient and has to be integrated out before the results start to have significance for the I-V characteristic. The determination of the observed voltage will then require a long period of integration before the mean value of $\dot{\phi}$ has attained a reasonably stable value. So a single I-V characteristic, where I is the only parameter to be varied is a tedious job. In the following we keep the ac-amplitude and the driving frequency fixed, $A = 1$, $f = 0.4$.

The period of the ac-current, $1/f$, is the only natural unit of discrete time. At all the times 0 , $1/f$, $2/f$, $3/f$, -

the situation with respect to the external world is the same. If we could find a simple mapping from the state $(\phi, \dot{\phi})$ at one of these times to the state at the next time in the discrete series, the whole investigation could be made much faster.

For the case $Q = 0$ the situation is even simpler, because ϕ is the only state variable. Instead of ϕ we use the reduced phase

$$y_n = \phi(n/f)/2\pi \quad (14)$$

so when ϕ is confined to the interval from 0 to 2π , y will lie between 0 and 1. The return map, F , defined by

$$y_{n+1} = F(y_n) \quad (15)$$

will then be well defined, and because there is a unique solution curve for every ϕ at a given time, we can be sure that F is a monotonous function. In some cases the discrete solutions y_n will repeat themselves after a small period and a graphical representation of y_{n+1} versus y_n will only show isolated dots, but in other cases a whole curve can be traced out. Fig. 3 shows such a case.

In general the return map for the Josephson equation, when it exists, can be shown to be a circle map⁵, i.e. a non-linear mapping of the unit circle on itself. The function F has two points of inflection and is reasonably well described as a case of Arnold's sine map⁶:

$$y_{n+1} = y_n + \Omega - (K/2\pi) \cdot \sin(2\pi \cdot y_n) \quad (16)$$

where the values of the dynamical variable y have to be reduced to the interval between 0 and 1. When comparing the return maps (15) to the sine map (16) one must allow for an arbitrariness in the choice of the phase of the ac-current at the discrete instants picked out. This means that there will be an arbitrary offset in the y -scale, so that the two points of inflection do not occur for $y=0$ and $y=1/2$, as they do for the sine map. This is, however, not essential.

The surprising thing is that the sine map fits the return maps so well, even when $Q > 0$ and the state space is two dimensional. The explanation is that the dissipative character of the system ensures that the discrete motion in the $(\phi, \dot{\phi})$ plane after the transient period will be restricted to an attractor of dimension lower than 2, and that in typical cases this attractor will define $\dot{\phi}$ as a single-valued function of ϕ . For $Q=0$ we have according to (9):

$$\dot{\phi}_n = I - \sin \phi_n \quad (17)$$

so for small values of Q we can expect something similar.

For $Q=0$ the return map is necessarily increasing, so the parameter K for the approximating sine map is less than 1. The circle map is then subcritical. The value of K is one minus the slope of the tangent at the point of inflection (comp. fig. 3). For $Q>0$ we may find a supercritical return map with $K>1$ and negative slope of the tangent, as shown in fig. 4. Correspondingly, in such cases the discrete attractor in the $(\phi, \dot{\phi})$ plane for some values of ϕ allows more than one value of $\dot{\phi}$, as can be seen in fig. 5. A closer inspection of the supercritical return

maps reveal small wiggles, so they are not strictly univalued⁵, but for a slightly supercritical case the wiggles are too small to be seen on a normal scale and are not important for the gross features of the I-V characteristics. We conclude that the return maps for the Josephson equation are well described by the sine map for the subcritical, critical and slightly supercritical cases.

When investigating the dynamics of the sine map (16) one normally chooses a fixed value of K and determines the winding number

$$W = \lim_{n \rightarrow \infty} (y_n - y_0)/n \quad (18)$$

as a function of the parameter Ω . It then turns out that phase-locking occurs for every rational value $W = p/q$ in a finite Ω -interval. These phase locking intervals correspond to the steps on the Josephson I-V characteristics, both harmonic and subharmonic, but the correspondence is not straightforward, because when we vary I alone, both Ω and K change; $\Omega(I)$ is increasing, while $K(I)$ is decreasing. For some values of Q a transition takes place from supercritical to subcritical behaviour when I increases beyond a value $I_1(Q)$. The transition can only be seen on the I-V curves when $I_1(Q)$ is greater than the smallest current that allows a solution with nonzero voltage. For $A=1$, $f=0.4$ this will be the case in the interval $0.4 < Q < 1.1$; I_1 has a maximum ≈ 1.3 for $Q \approx 2$. No supercritical parts can be found on the I-V characteristics for these values of A and f with winding numbers above 0.44.

Fig. 6 shows three different return maps for the same

current $I = 1.05$ but three different Q -values, 0.3, 1, and 1.5. For $Q = 1$ we see only three isolated groups of points of three points each. This is a case of phase-locking and the winding number is $1/3$, but as there are nine points the mode structure is not $1/3$, but $3/9$. For a supercritical case there are several modes for some of the winding numbers that correspond to irreducible fractions p/q . This is because there is a local maximum on the circle map for $K > 1$, and therefore we can expect to find traces of the Feigenbaum route to chaos superposed on the mode locked steps.

For the subcritical circle map there is a finite measure of q -values giving an irrational winding number, but in the critical case, $K = 1$, this measure is zero and the values form a Cantor-set of fractal dimension 0.87, as will be discussed in the next section. For supercritical cases some of the phase-locked q -intervals overlap, meaning that we can find different winding numbers for the same q . This gives rise to hysteresis in the Josephson I - V curves, a feature that can be used for distinguishing supercritical regions from subcritical ones when looking at experimental data. However, there is another sort of hysteresis as regards the supercurrent for $Q > 1$. For $Q = 1.5$ we can lower the current from above 1 down to about 0.7 and find a subcritical circle map all the way, until it touches the line $y_{n+1} = y_n$ at which point the transition to zero voltage suddenly takes place. Raising the current again we stay on the supercurrent (the 0/1 step) until the current is almost 1, when the winding number changes discontinuously from 0 to 0.41. Apparently the return map between these two transitions includes an isolated point on the line.

3. The critical sine map .

The winding number W as a function of the driving parameter α for the sine map forms a "Devil's staircase". For the critical case $K = 1$ the staircase is complete, which means that the steps for rational W together have the same measure as the α -domain, although they do not cover it completely but leave a Cantor-set of zero measure. Considering α as a function of W we have the curious case of a function that is discontinuous for all rational values, but continuous for all irrational values of W . Fig. 7 shows a graph of the complete staircase for $0 < \alpha < \frac{1}{2}$. This is sufficient, because $W(1-\alpha) = 1 - W(\alpha)$.

The dynamical process for the critical sine map can be depicted as in fig. 8, where subsequent values of y (reduced to the interval between 0 and 1) have been plotted while α slowly increases from 0 to $\frac{1}{2}$. There is no real "chaos" in this picture, although it may look so. An irrational winding number corresponds to a quite regular motion on the circle, although it never repeats itself.

The critical sine map is particularly interesting because it shows a universal scaling structure common to all circle maps with a horizontal slope at the point of inflection, provided that the local behaviour is cubic. Shenker showed⁷ for the Fibonacci-fractions q_n/q_{n+1} , where the numerator and the denominator are consecutive members of the Fibonacci-sequence

$$1, 1, 2, 3, 5, 8, \dots, q_n = q_{n-1} + q_{n-2}, \dots \quad (19)$$

that the stability intervals asymptotically scale with the

power law

$$\Delta \Omega(q_{n-1}/q_n) \propto q_n^{-2.164} \quad (20)$$

If all stability intervals for $W = p/q$ scaled with the denominator in the same power, $-\alpha$, we could easily calculate the fractal dimension for the set of qs with irrational W . If $L(\Delta)$ denotes the measure seen when all stability intervals less than Δ are ignored, we have

$$dL(\Delta)/d\Delta \propto \tilde{q}(\Delta)^{1-\alpha} \cdot d\tilde{q}(\Delta)/d\Delta \quad (21)$$

where we have used that the number of irreducible fractions with denominator q is proportional to q , asymptotically. The quantity $\tilde{q}(\Delta)$ is the largest denominator whose stability interval can be seen with the Δ -scale, i.e. $\tilde{q} \propto \Delta^{-1/\alpha}$, and therefore

$$dL(\Delta)/d\Delta \propto \Delta^{-2/\alpha} \quad (22)$$

But by definition⁸ of D , the fractal dimension, $L \propto \Delta^{1-D}$, so we should have

$$D = 2/\alpha \quad (23)$$

Shenker's value, $\alpha = 2.164$ would thus give $D = 0.924$. A direct measurement using calculated stability intervals and the definition of D gives however⁹,

$$D = 0.870 \quad (24)$$

so, it seems that the Fibonacci fractions studied by Shenker are not very "typical". In fact they are extreme in the

sense that the Fibonacci intervals are always the largest for fractions with the same denominator. Another extreme are the fractions $1/q$ which always have the smallest intervals for the given q . These intervals are easily shown to go like q^{-3} , a consequence of the fact that N rises like a square root on the lowest part of the Devil's staircase.

The best way to define what is meant by "extreme" or "typical" fractions is based on the continued fraction expansion

$$p/q = 1/(a_1 + 1/(a_2 + 1/(a_3 + \dots + 1/a_N))) \dots \quad (25)$$

The number of terms, $N(p/q)$ can be shown to lie between the limits 1 and $N_{\max}(q)$, where $N_{\max}(q)$ is the number characterizing the Fibonacci-fractions for which all the terms are 1. Asymptotically for q large:

$$N_{\max}(q) = \frac{\ln[(3-\tau) \cdot q]}{\ln \tau} \quad (26)$$

where $\tau = (\sqrt{5}+1)/2$ is the golden mean ($1/\tau$ is the limiting value of the Fibonacci-fractions). An even better way of characterizing the fractions is to use the sum of terms

$$S = \sum a_n \quad (27)$$

For given q , S will lie between the maximum q (for $1/q$) and the minimum, attained by the Fibonacci-fractions

$$S_{\min}(q) = N_{\max}(q) \quad (28)$$

As a rule of thumb one can say that the length of the

stability intervals $\Delta\Omega(p/q)$ depends only on q and S , i.e. if two fractions have identical values of q and S we can be sure that the corresponding stability intervals have equal lengths within a few percent, even if their N values differ.

A way of characterizing "typical" fraction is suggested by the result¹⁰ that the values of N for large q are normally distributed around the value

$$N_t(q) = \frac{12 \ln 2}{\pi^2} \cdot \ln q \quad (29)$$

with a standard deviation given by $\ln N_t$. The value N_t is about 40% of N_{\max} . If we look at the quantity

$$\sigma(q, S) = [1 + (S - S_{\min}) / (N_t \ln N_t)]^{-1} \quad (30)$$

we can see that it is confined to the interval between 0 and 1. Furthermore, it will have a rather stable distribution around the "typical" value $\frac{1}{2}$. An empirical formula for the phase-locking intervals is given by

$$\Delta\Omega(p/q) \approx b \cdot (q/r)^{-\xi(\sigma)} \quad (31)$$

where $b \approx 0.035$ and $r \approx 2.8$. The exponent ξ is given by the expression (30) using the interpolation formula

$$\xi(\sigma) \approx 2 + 1 / (5.1 \cdot \sigma + 1) \quad (32)$$

The expressions (30)-(32) summarize some of the main known features of the critical sine map and give within 10% uncertainties the correct magnitudes of the intervals, at least up to denominators about 100. However, it does not

pretend to give any exact insight in the self-similar structure. The self-similarity is not strict, but slightly modulated from place to place on the staircase, but still, the overall fractal dimension $D = 0.870$ seems very well defined. The universality of this result is confirmed by direct measurements of D on the critical steps of IV-characteristics for Josephson junctions simulated on an analog computer¹¹.

A proper theory for the scaling properties may lie hidden in the particular ordering of rational numbers known as the Farey-tree ¹². For a given value of the sum S ($S > 1$) there are exactly 2^{S-2} irreducible fractions between 0 and 1, which suggests that all these fractions may be ordered in a binary tree where each layer has a constant S . As shown in fig. 9 the construction is very simple: a fraction is formed by adding both the numerators and the denominators of the nearest adjacent fractions on the left and the right in the layers above. This will preserve the natural ordering of all the numbers from left to right. Fig. 9 shows also how to determine the number of terms in the continued fraction expansion by visual inspection: The branches of the tree are drawn alternating between solid and dashed lines. By starting in the point $1/1$ where $N=1$ and going to another point p/q , N is increased by one for every solid line and stays constant on the dashed lines.

The number theoretical mysteries hidden in such hard boiled physical problems as the Josephson junction and the pendulum have just begun to reveal themselves through the experimental mathematics of the circle maps.

Acknowledgements .

The author gratefully acknowledges stimulating discussions with T. Bohr, P. Cvitanovic, and M. T. Levinsen.

References .

1. L. D. Landau and V. L. Ginzburg, Zh. Eksperim. i Teor. Fiz., 20 , 1064 (1950).
2. P. V. Christiansen, E. B. Hansen and C. J. Sjöström, J. Low Temp. Phys., 4 , 349 (1971).
3. D. E. McCumber, J. Appl. Phys., 39 , 3113 (1968).
4. G. M. Eliashberg, Zh. Eksperim. i Teor. Fiz. Pis. Red., 11 , 186 (1970).
5. P. Bak, T. Bohr, M. H. Jensen and P. V. Christiansen, Solid State Comm., 51 , 231 (1984).
6. V. I. Arnold, Izv. Acad. Nauk., 25 , 21 (1961); Trans. Am. Math. Soc., 46 , 213 (1965).
7. S. J. Shenker, Physica, 5D , 405 (1982).
8. B. Mandelbrot, "Fractals: Form, Chance, and Dimension", W. H. Freeman, San Fransisco (1977).
9. M. H. Jensen, P. Bak and T. Bohr, Phys. Rev. Lett., 50 , 1637 (1983).
10. A. I. Khinchin, "Kettenbrüche", B. G. Teubner, Leipzig (1956).
11. W. J. Yeh, D. a-Ren He and Y. H. Kao, Phys. Rev. Lett., 52 , 480 (1984).
- P. Alstrøm and M. T. Levinsen, Phys. Rev. B 31 , 2753 (1985); *ibid.* 32 , 1503 (1985).
12. P. Cvitanovic and B. Shraiman, private communication.

Figure captions .

Fig. 1 . Iconic models of physical analogies for the Josephson equation.

Fig. 2 . Current (I) - voltage (V) characteristics for Josephson junction. Solid curve: without ac-current. Dotted curve: with ac-current. Line: normal conductivity.

Fig. 3 . Return map for $Q=0$ showing how to determine K by the slope of the tangent at the point of inflection.

Fig. 4 . Supercritical return map.

Fig. 5 . Discrete attractor corresponding to the return map of fig. 4. Horizontal: ϕ , vertical: $\dot{\phi}$. The arrow indicates a place where $\dot{\phi}$ is not uniquely determined from ϕ .

Fig. 6 . Three return maps for the same current.

Fig. 7 . Devil's staircase for the critical sine map.

Fig. 8 . Dynamics of the critical sine map.

Fig. 9 . The Farey-tree.

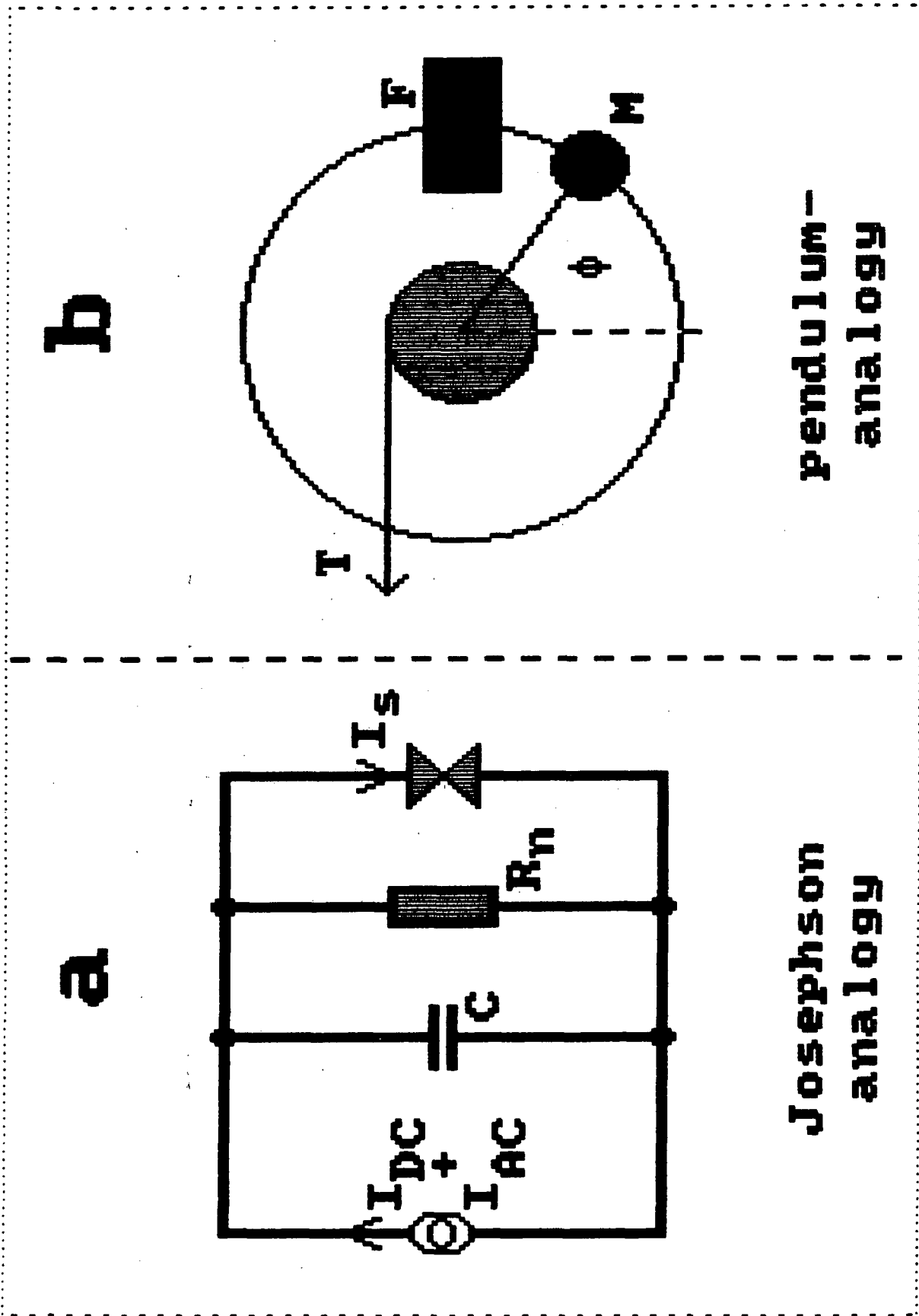

(up)

Fig. 1

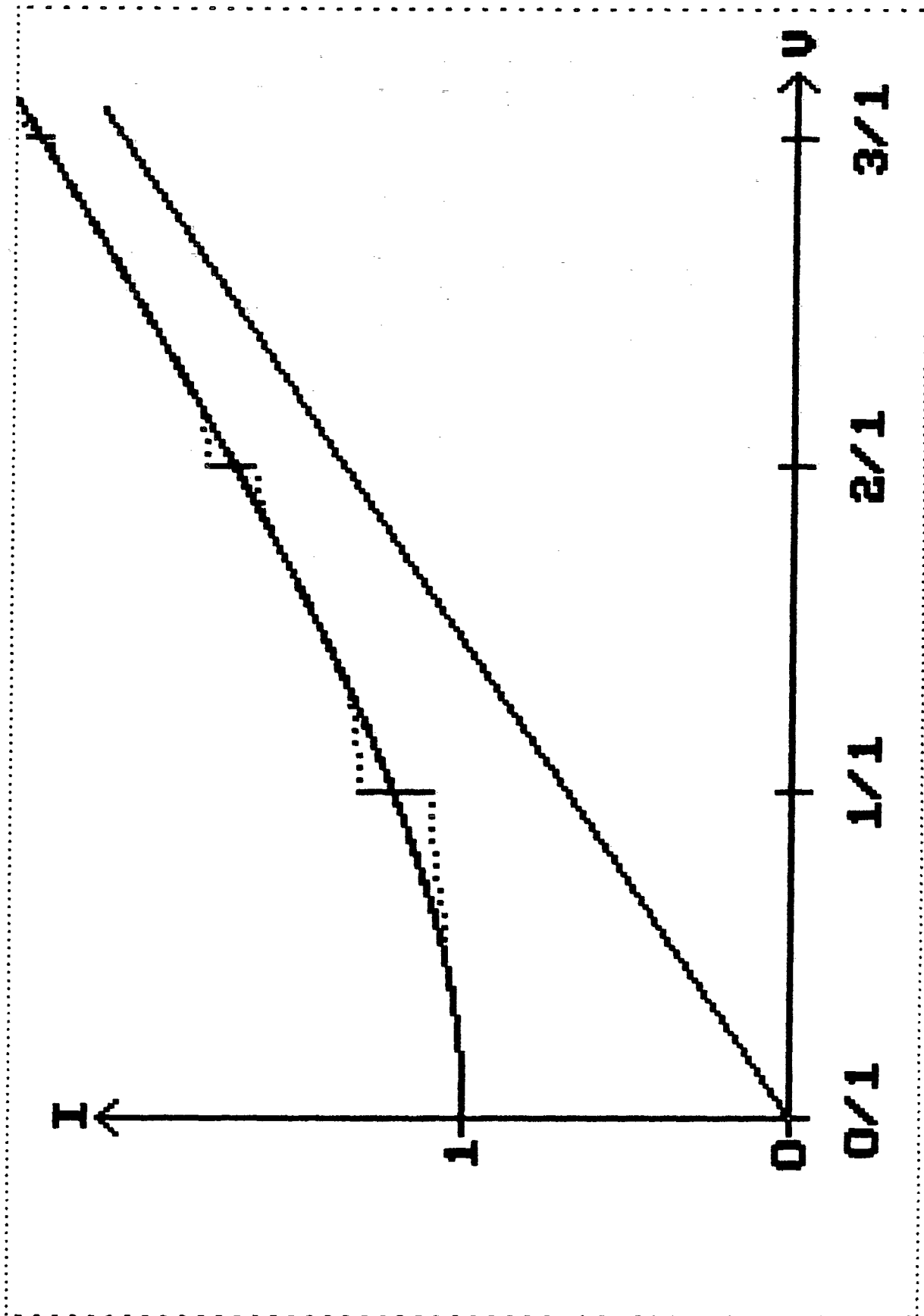

(up)

Fig. 2

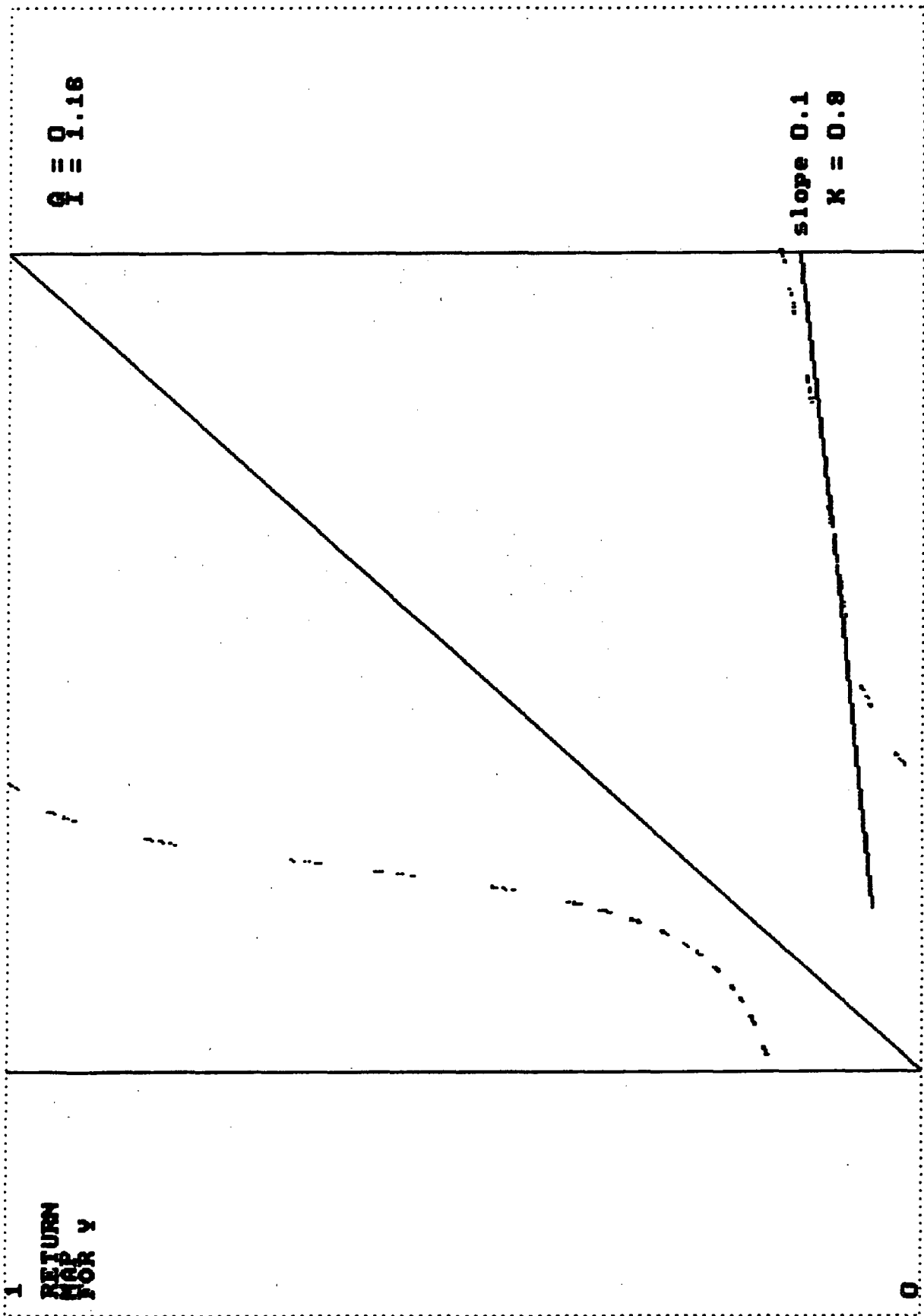

(up)

Fig. 3

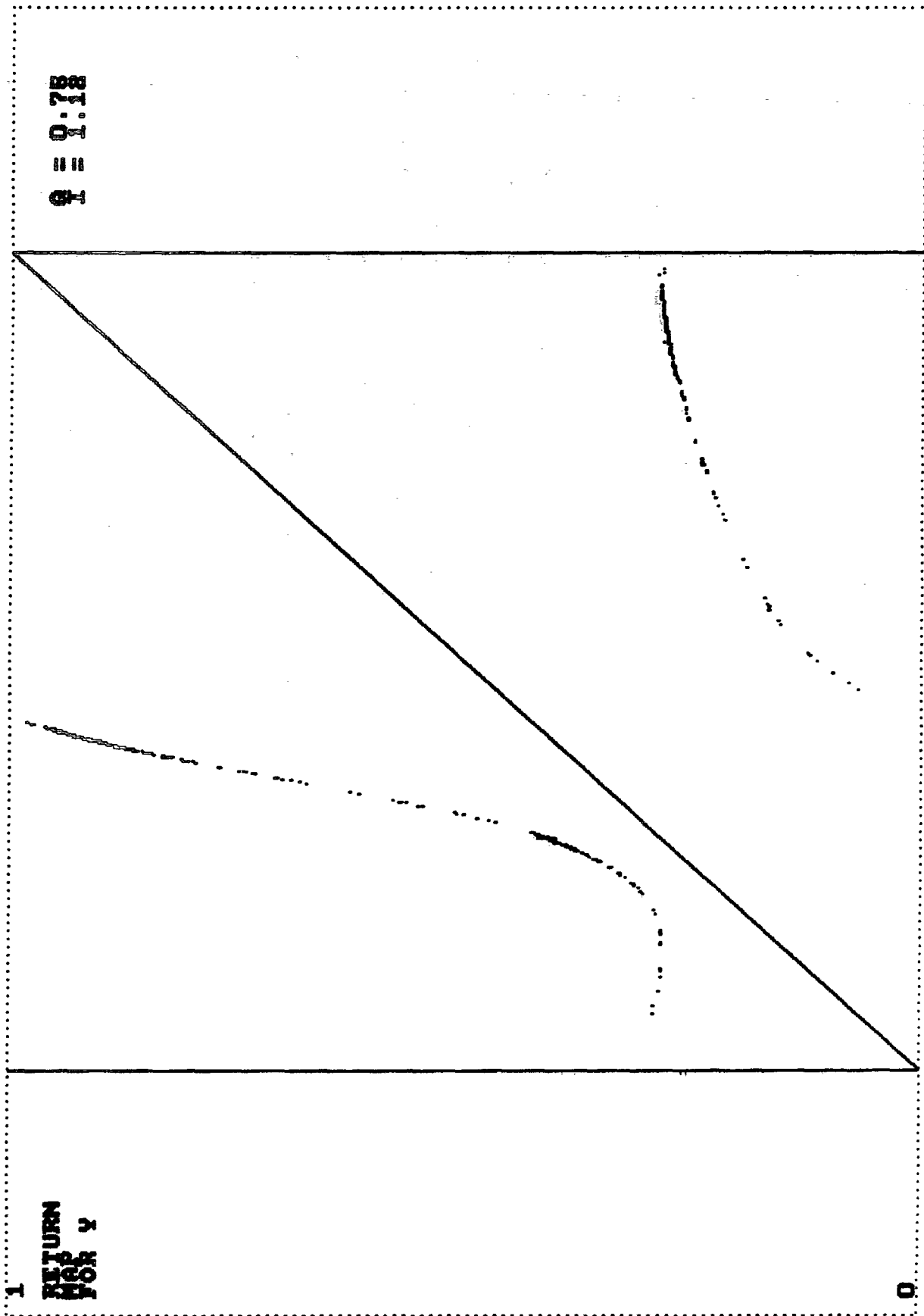

(up)

Fig. 4

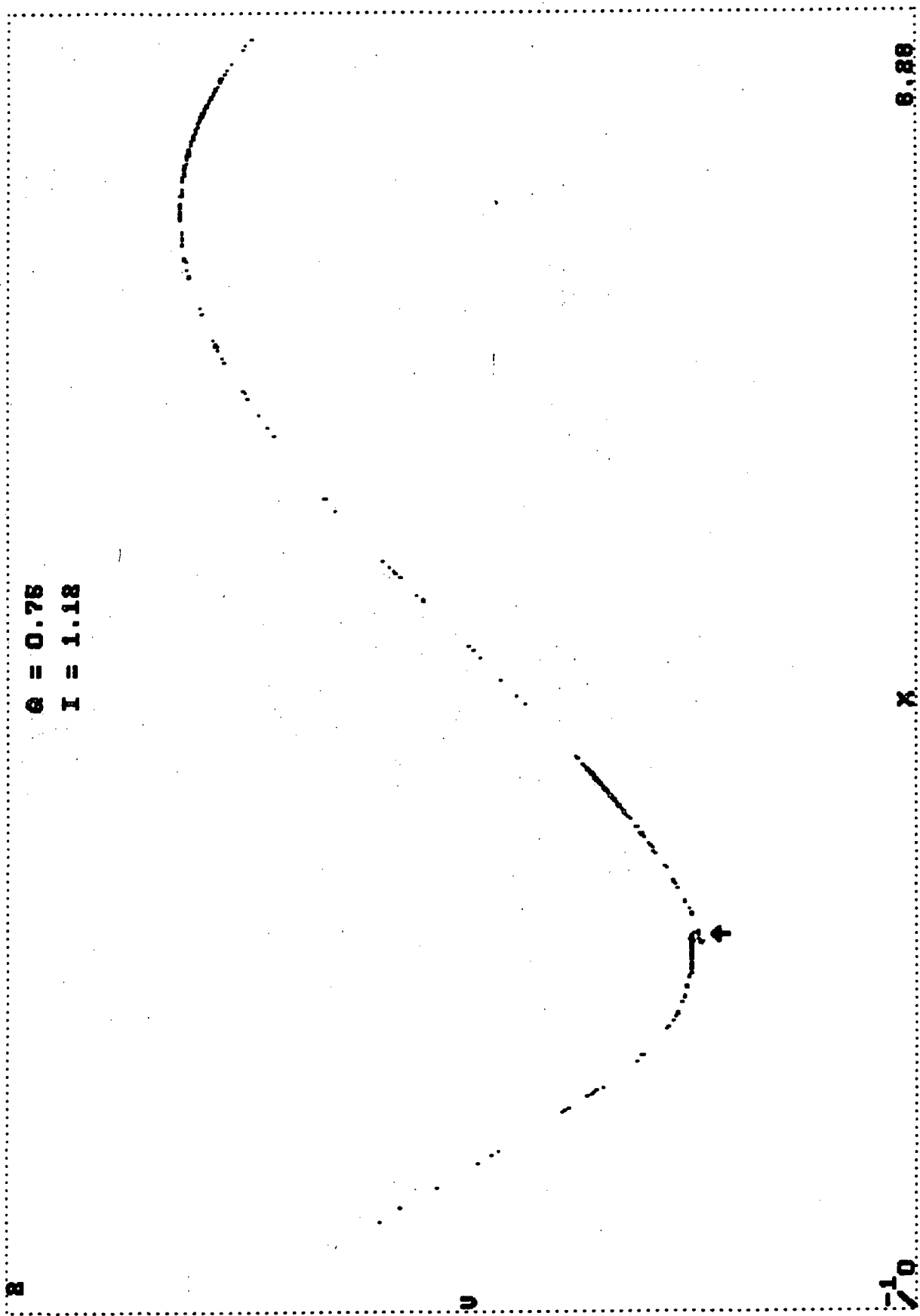

(up)

Fig. 5

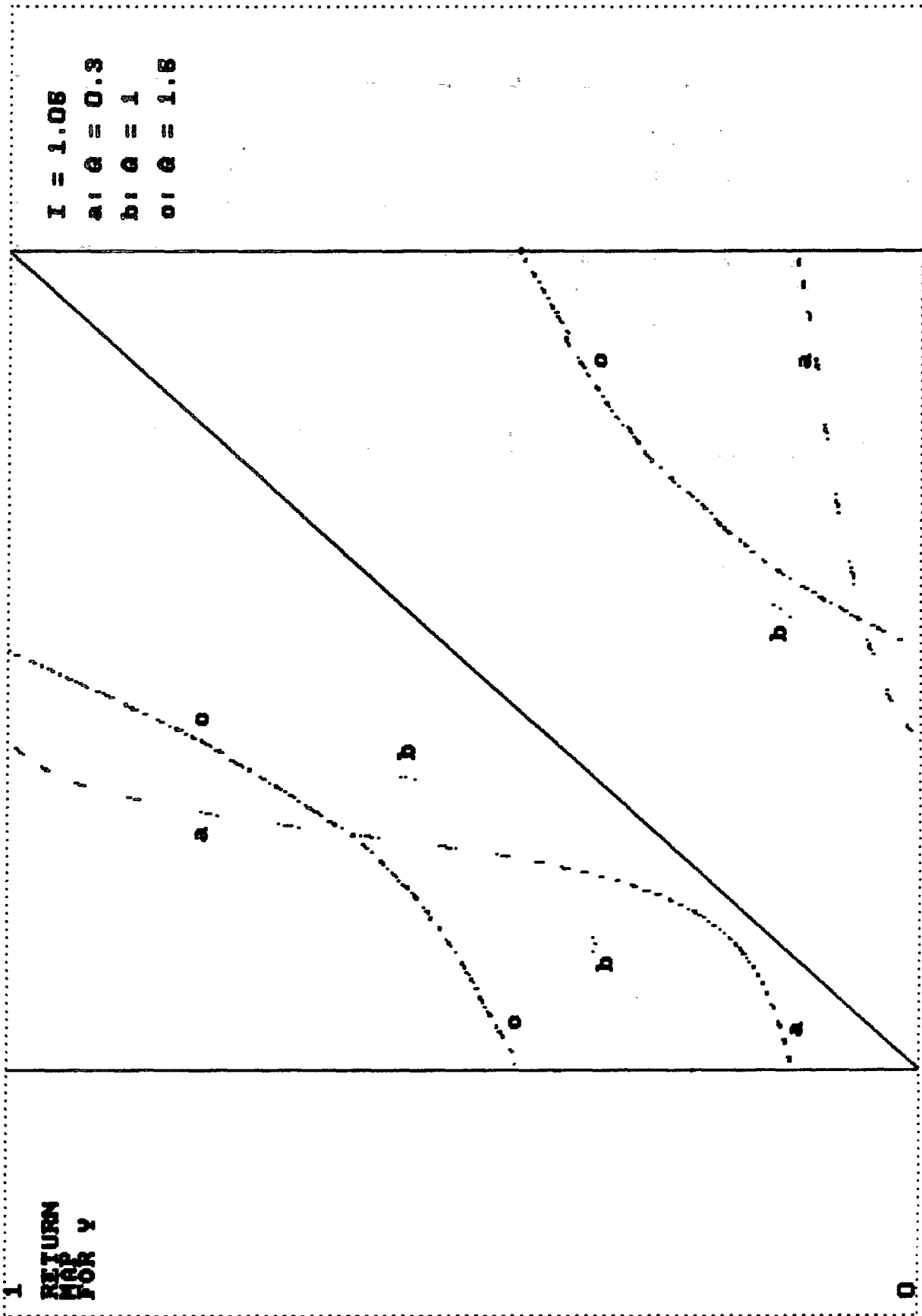

(up)

Fig. 6

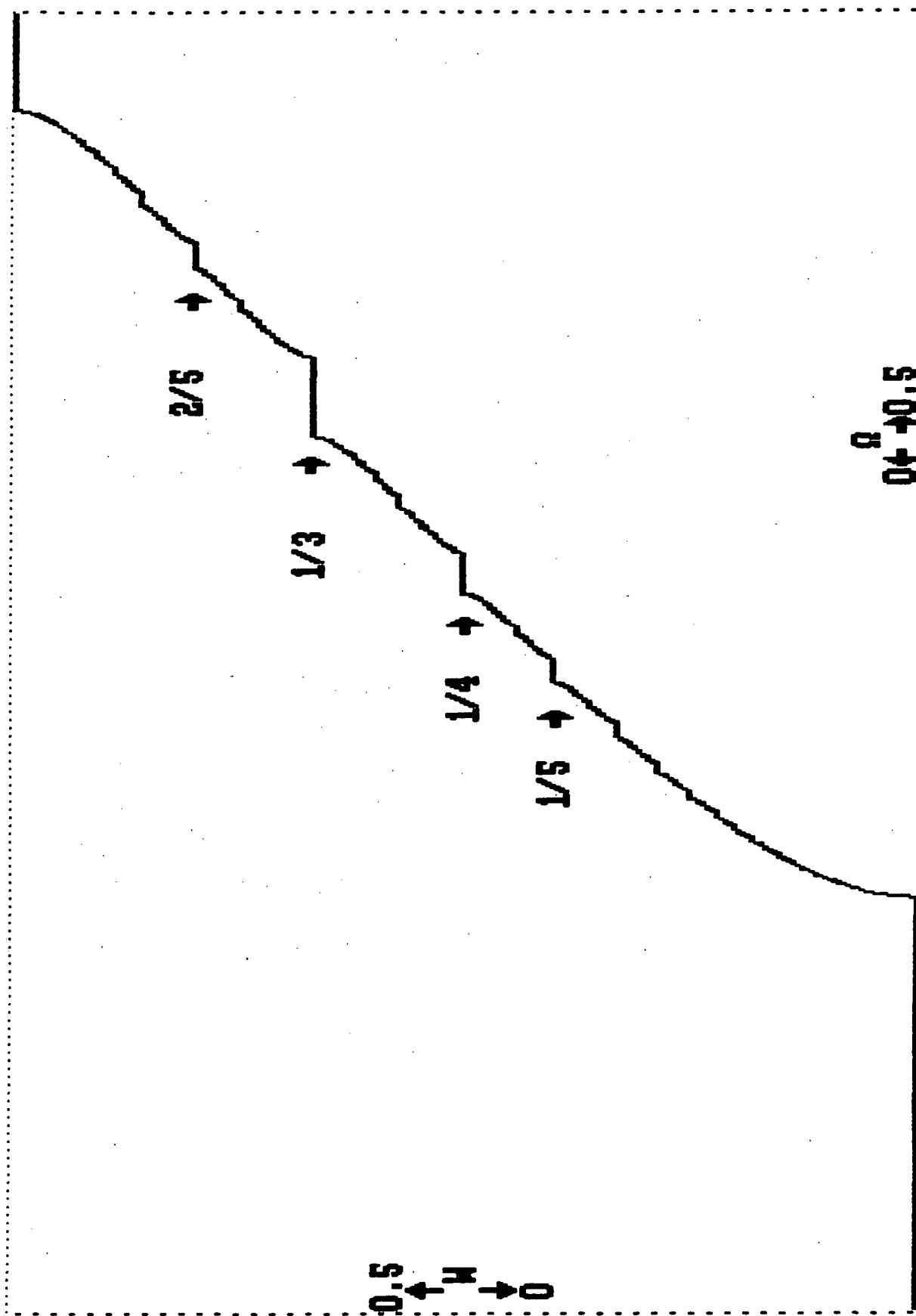

(up)

Fig. 7

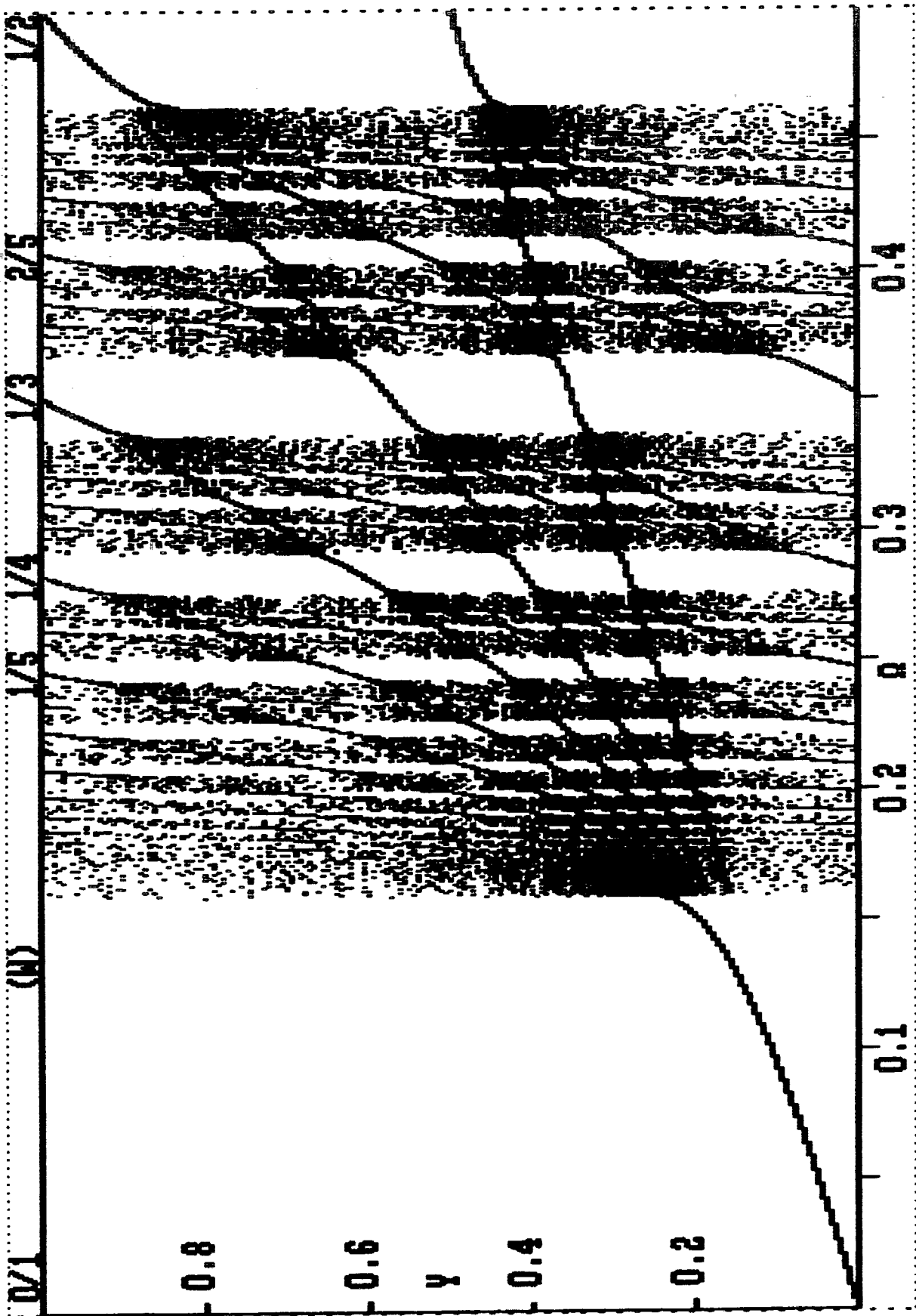

(up)

Fig. 8

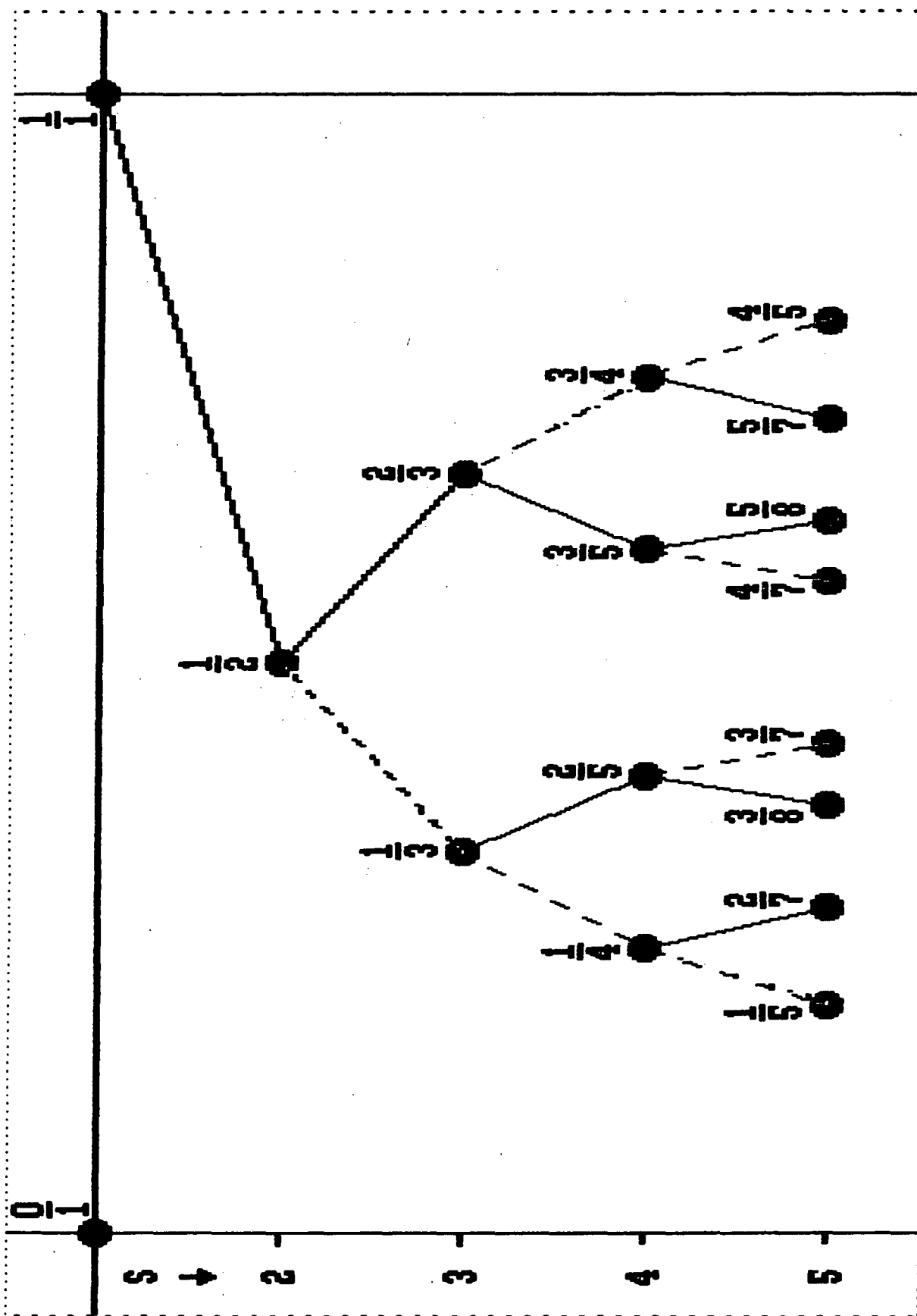

(up)

Fig. 9

- 1/78 "TANKER OM EN PRAKSIS" - et matematikprojekt.
 Projektrapport af: Anne Jensen, Lena Lindenskov, Marianne Kesselhahn og Nicolai Lomholt.
 Vejleder: Anders Madsen
- 2/78 "OPTIMERING" - Menneskets forøgede beherskelsesmuligheder af natur og samfund.
 Projektrapport af: Tom J. Andersen, Tommy R. Andersen, Gert Krenøe og Peter H. Lassen
 Vejleder: Bernhelm Boss.
- 3/78 "OPCAVESAMLING", breddekursus i fysik.
 Af: Lasse Rasmussen, Aage Bonde Kræmmer og Jens Højgaard Jensen.
- 4/78 "TRE ESSAYS" - om matematikundervisning, matematiklæreruddannelsen og videnskabsrindalismen.
 Af: Mogens Niss
 Nr. 4 er p.t. udgået.
- 5/78 "BIBLIOGRAFISK VEJLEDNING til studiet af DEN MODERNE FYSIKS HISTORIE".
 Af: Helge Kragh.
 Nr. 5 er p.t. udgået.
- 6/78 "NOGLE ARTIKLER OG DEBATINDLÆG OM - læreruddannelse og undervisning i fysik, og - de naturvidenskabelige fags situation efter studenteroprøret".
 Af: Karin Beyer, Jens Højgaard Jensen og Bent C. Jørgensen.
- 7/78 "MATEMATIKKENS FORHOLD TIL SAMFUNDSØKONOMIEN".
 Af: B.V. Gnedenko.
 Nr. 7 er udgået.
- 8/78 "DYNAMIK OG DIAGRAMMER". Introduktion til energy-bond-graph formalismen.
 Af: Peder Voetmann Christiansen.
- 9/78 "OM PRAKSIS' INDFLYDELSE PÅ MATEMATIKKENS UDVIKLING". - Motiver til Kepler's: "Nova Stereometria Doliorum Vinariorum".
 Projektrapport af: Lasse Rasmussen.
 Vejleder: Anders Madsen.
-
- 10/79 "TERMODYNAMIK I GYMNASIET".
 Projektrapport af: Jan Christensen og Jeanne Mortensen.
 Vejledere: Karin Beyer og Peder Voetmann Christiansen.
- 11/79 "STATISTISKE MATERIALER".
 Af: Jørgen Larsen.
- 12/79 "LINEÆRE DIFFERENTIALLIGNINGER OG DIFFERENTIALLIGNINGSSYSTEMER".
 Af: Mogens Brun Heefelt.
 Nr. 12 er udgået.
- 13/79 "CAVENDISH'S FORSØG I GYMNASIET".
 Projektrapport af: Gert Kreinøe.
 Vejleder: Albert Chr. Paulsen.
- 14/79 "BOOKS ABOUT MATHEMATICS: History, Philosophy, Education, Models, System Theory, and Works of".
 Af: Else Høyrup.
 Nr. 14 er p.t. udgået.
- 15/79 "STRUKTUREL STABILITET OG KATASTROFER i systemer i og udenfor termodynamisk ligevægt".
 Specialeopgave af: Leif S. Striegler.
 Vejleder: Peder Voetmann Christiansen.
- 16/79 "STATISTIK I KRÆFTFORSKNINGEN".
 Projektrapport af: Michael Olsen og Jørn Jensen.
 Vejleder: Jørgen Larsen.
- 17/79 "AT SPØRGE OG AT SVARE i fysikundervisningen".
 Af: Albert Christian Paulsen.
- 18/79 "MATHEMATICS AND THE REAL WORLD", Proceedings af an International Workshop, Roskilde University Centre, Denmark, 1978.
 Preprint.
 Af: Bernhelm Booss og Mogens Niss (eds.)
- 19/79 "GEOMETRI, SKOLE OG VIRKELIGHED".
 Projektrapport af: Tom J. Andersen, Tommy R. Andersen og Per H.H. Larsen.
 Vejleder: Mogens Niss.
- 20/79 "STATISTISKE MODELLER TIL BESTEMMELSE AF SIKRE DOSER FOR CARCINOGENE STOFFER".
 Projektrapport af: Michael Olsen og Jørn Jensen.
 Vejleder: Jørgen Larsen
- 21/79 "KONTROL I GYMNASIET-FORMÅL OG KONSEKVENSER".
 Projektrapport af: Crilles Bacher, Per S.Jensen, Preben Jensen og Torben Nysteen.
- 22/79 "SEMIOTIK OG SYSTEMEGENSKABER (1)".
 1-port lineært response og støj i fysikken.
 Af: Peder Voetmann Christiansen.
- 23/79 "ON THE HISTORY AF EARLY WAVE MECHANICS - with special emphasis on the role af reality".
 Af: Helge Kragh.
-
- 24/80 "MATEMATIKOPFATTELSE HOS 2.G'ERE".
 a+b 1. En analyse. 2. Interviewmateriale.
 Projektrapport af: Jan Christensen og Knud Lindhardt Rasmussen.
 Vejleder: Mogens Niss.
- 25/80 "EKSAMENSOPGAVER", Dybdemodulet/fysik 1974-79.
- 26/80 "OM MATEMATISKE MODELLER".
 En projektrapport og to artikler.
 Af: Jens Højgaard Jensen m.fl.
- 27/80 "METHODOLOGY AND PHILOSOPHY AF SCIENCE IN PAUL DIRAC'S PHYSICS".
 Af: Helge Kragh.
- 28/80 "DILENTRISK RELAXATION - et forslag til en ny model bygget på væskernes viscoelastiske egenskaber".
 Projektrapport af: Gert Kreinøe.
 Vejleder: Niels Boye Olsen.
- 29/80 "ODIN - undervisningsmateriale til et kursus i differentiaalligningsmodeller".
 Projektrapport af: Tommy R. Andersen, Per H.H. Larsen og Peter H. Lassen.
 Vejleder: Mogens Brun Heefelt.
- 30/80 "FUSIONSENERGIEN - - - ATOMSAMFUNDETS ENDESTATION".
 Af: Oluf Danielsen.
 Nr. 30 er udgået.
- 31/80 "VIDENSKABSTEORETISKE PROBLEMER VED UNDERVISNINGSSYSTEMER BASERET PÅ MÆNGDELÆRE".
 Projektrapport af: Troels Lange og Jørgen Karrebæk.
 Vejleder: Stig Andur Pedersen.
 Nr. 31 er p.t. udgået.
- 32/80 "POLYMERE STOFFERS VISCOELASTISKE EGENSKABER - BELYST VED HJÆLP AF MEKANISKE IMPEDANSMÅLINGER - MØSSBAUEREFFEKTMÅLINGER".
 Projektrapport af: Crilles Bacher og Preben Jensen.
 Vejledere: Niels Boye Olsen og Peder Voetmann Christiansen.
- 33/80 "KONSTITUERING AF FAG INDEN FOR TEKNISK - NATURVIDENSKABELIGE UDDANNELSER. I-II".
 Af: Arne Jakobsen.
- 34/80 "ENVIRONMENTAL IMPACT AF WIND ENERGY UTILIZATION".
 ENERGY SERIES NO. I.
 Af: Bent Sørensen
 Nr. 34 er udgået.

- 35/80 "HISTORISKE STUDIER I DEN NYERE ATOMFYSIKS UDVIKLING".
Af: Helge Kragh.
- 36/80 "HVAD ER MENINGEN MED MATEMATIKUNDERVISNINGEN?".
Fire artikler.
Af: Mogens Niss.
- 37/80 "RENEWABLE ENERGY AND ENERGY STORAGE".
ENERGY SERIES NO. 2.
Af: Bent Sørensen.
-
- 38/81 "TIL EN HISTORIE TEORI OM NATURERKENDELSE, TEKNOLOGI OG SAMFUND".
Projektrapport af: Erik Gade, Hans Hedal, Henrik Lau og Finn Physant.
Vejledere: Stig Andur Pedersen, Helge Kragh og Ib Thiersen.
Nr. 38 er p.t. udgået.
- 39/81 "TIL KRITIKKEN AF VÆKSTØKONOMIEN".
Af: Jens Højgaard Jensen.
- 40/81 "TELEKOMMUNIKATION I DANMARK - oplæg til en teknologivurdering".
Projektrapport af: Arne Jørgensen, Bruno Petersen og Jan Vedde.
Vejleder: Per Nørregaard.
- 41/81 "PLANNING AND POLICY CONSIDERATIONS RELATED TO THE INTRODUCTION OF RENEWABLE ENERGY SOURCES INTO ENERGY SUPPLY SYSTEMS".
ENERGY SERIES NO. 3.
Af: Bent Sørensen.
- 42/81 "VIDENSKAB TEORI SAMFUND - En introduktion til materialistiske videnskabsopfattelser".
Af: Helge Kragh og Stig Andur Pedersen.
- 43/81 1. "COMPARATIVE RISK ASSESSMENT OF TOTAL ENERGY SYSTEMS".
2. "ADVANTAGES AND DISADVANTAGES OF DECENTRALIZATION".
ENERGY SERIES NO. 4.
Af: Bent Sørensen.
- 44/81 "HISTORISKE UNDERSØGELSER AF DE EKSPERIMENTELLE FORUDSÆTNINGER FOR RUTHERFORDS ATOMMODEL".
Projektrapport af: Niels Thor Nielsen.
Vejleder: Bent C. Jørgensen.
-
- 45/82 Er aldrig udkommet.
- 46/82 "EKSEMPLARISK UNDERVISNING OG FYSISK ERKENDELSE-
1+1 ILLUSTRERET VED TO EKSEMPLER".
Projektrapport af: Torben O. Olsen, Lasse Rasmussen og Niels Dreyer Sørensen.
Vejleder: Bent C. Jørgensen.
- 47/82 "BARSEBÄCK OG DET VÆRST OFFICIELT-TÆNKELIGE UHELD".
ENERGY SERIES NO. 5.
Af: Bent Sørensen.
- 48/82 "EN UNDERSØGELSE AF MATEMATIKUNDERVISNINGEN PÅ ADGANGSKURSUS TIL KØBENHAVNS TEKNIKUM".
Projektrapport af: Lis Eilertzen, Jørgen Karrebæk, Troels Lange, Preben Nørregaard, Lissi Pedersen, Laust Rishøj, Lill Røn og Isaac Showiki.
Vejleder: Mogens Niss.
- 49/82 "ANALYSE AF MULTISPEKTRALE SATELLITBILLEDER".
Projektrapport af: Preben Nørregaard.
Vejledere: Jørgen Larsen og Rasmus Ole Rasmussen.
- 50/82 "HERSLEV - MULIGHEDER FOR VEDVARENDE ENERGI I EN LANDSBY".
ENERGY SERIES NO. 6.
Rapport af: Bent Christensen, Bent Hove Jensen, Dennis B. Møller, Bjarne Laursen, Bjarne Lillethorup og Jacob Mørch Pedersen.
Vejleder: Bent Sørensen.
- 51/82 "HVAD KAN DER GØRES FOR AT AFHJÆLPE PIGERS BLOKERING OVERFOR MATEMATIK?".
Projektrapport af: Lis Eilertzen, Lissi Pedersen, Lill Røn og Susanne Stender.
- 52/82 "DESUSPENSION OF SPLITTING ELLIPTIC SYMBOLS".
Af: Bernhelm Booss og Krzysztof Wojciechowski.
- 53/82 "THE CONSTITUTION OF SUBJECTS IN ENGINEERING EDUCATION".
Af: Arne Jacobsen og Stig Andur Pedersen.
- 54/82 "FUTURES RESEARCH" - A Philosophical Analysis of Its Subject-Matter and Methods.
Af: Stig Andur Pedersen og Johannes Witt-Hansen.
- 55/82 "MATEMATISKE MODELLER" - Litteratur på Roskilde Universitetsbibliotek.
En biografi.
Af: Else Høytrup.

Vedr. tekst nr. 55/82 se også tekst nr. 62/83.
- 56/82 "EN - TO - MANGE" -
En undersøgelse af matematisk økologi.
Projektrapport af: Troels Lange.
Vejleder: Anders Madsen.
-
- 57/83 "ASPECT EKSPERIMENTET"-
Skjulte variable i kvantemekanikken?
Projektrapport af: Tom Juul Andersen.
Vejleder: Peder Voetmann Christiansen.
Nr. 57 er udgået.
- 58/83 "MATEMATISKE VANDRINGER" - Modelbetragtninger over spredning af dyr mellem småbiotoper i agerlandet.
Projektrapport af: Per Hammershøj Jensen og Lene Vagn Rasmussen.
Vejleder: Jørgen Larsen.
- 59/83 "THE METHODOLOGY OF ENERGY PLANNING".
ENERGY SERIES NO. 7.
Af: Bent Sørensen.
- 60/83 "MATEMATISK MODEKSPERTISE"- et eksempel.
Projektrapport af: Erik O. Gade, Jørgen Karrebæk og Preben Nørregaard.
Vejleder: Anders Madsen.
- 61/83 "FYSIKS IDEOLOGISKE FUNKTION, SOM ET EKSEMPEL PÅ EN NATURVIDENSKAB - HISTORISK SET".
Projektrapport af: Annette Post Nielsen.
Vejledere: Jens Høytrup, Jens Højgaard Jensen og Jørgen Vogelius.
- 62/83 "MATEMATISKE MODELLER" - Litteratur på Roskilde Universitetsbibliotek.
En biografi 2. rev. udgave.
Af: Else Høytrup.
- 63/83 "CREATING ENERGY FUTURES: A SHORT GUIDE TO ENERGY PLANNING".
ENERGY SERIES No. 8.
Af: David Crossley og Bent Sørensen.
- 64/83 "VON MATEMATIK UND KRIEG".
Af: Bernhelm Booss og Jens Høytrup.
- 65/83 "ANVENDT MATEMATIK - TEORI ELLER PRAKSIS".
Projektrapport af: Per Hedegård Andersen, Kirsten Habekost, Carsten Holst-Jensen, Annelise von Moos, Else Marie Pedersen og Erling Møller Pedersen.
Vejledere: Bernhelm Booss og Klaus Grünbaum.
- 66/83 "MATEMATISKE MODELLER FOR PERIODISK SELEKTION I ESCHERICHIA COLI".
Projektrapport af: Hanne Lisbet Andersen, Ole Richard Jensen og Klavs Frisdahl.
Vejledere: Jørgen Larsen og Anders Hede Madsen.
- 67/83 "ELEPSOIDE METODEN - EN NY METODE TIL LINEÆR PROGRAMMERING?".
Projektrapport af: Lone Billmann og Lars Boye.
Vejleder: Mogens Brun Heefelt.
- 68/83 "STOKASTISKE MODELLER I POPULATIONSGENETIK" - til kritikken af teoriladede modeller.
Projektrapport af: Lise Odgård Gade, Susanne Hansen, Michael Hviid og Frank Mølgård Olsen.
Vejleder: Jørgen Larsen.

- 69/83 "ELEVFORUDSÆNINGER I FYSIK"
- en test i l.g med kommentarer.
Af: Albert C. Paulsen.
- 70/83 "INDLÆRINGS - OG FORMIDLINGSPROBLEMER I MATEMATIK PÅ VOKSENUNDERVISNINGSNIVEAU".
Projektrapport af: Hanne Lisbet Andersen, Torben J. Andreasen, Svend Åge Houmann, Helle Glerup Jensen, Keld Fl. Nielsen, Lene Vagn Rasmussen.
Vejleder: Klaus Grünbaum og Anders Hede Madsen.
- 71/83 "PIGER OG FYSIK"
- et problem og en udfordring for skolen?
Af: Karin Beyer, Sussanng Blegaa, Birthe Olsen, Jette Reich og Mette Vedelsby.
- 72/83 "VERDEN IFVLGE PEIRCE" - to metafysiske essays, om og af C.S Peirce.
Af: Peder Voetmann Christiansen.
- 73/83 ""EN ENERGIANALYSE AF LANDBRUG"
- økologisk contra traditionelt.
ENERGY SERIES NO. 9
Specialeopgave i fysik af: Bent Hove Jensen.
Vejleder: Bent Sørensen.
-
- 74/84 "MINIATURISERING AF MIKROELEKTRONIK" - om videnskabeliggjort teknologi og nytten af at lære fysik.
Projektrapport af: Bodil Harder og Linda Szkotak Jensen.
Vejledere: Jens Højgaard Jensen og Bent C. Jørgensen.
- 75/84 "MATEMATIKUNDERVISNINGEN I FREMTIDENS GYMNASIUM"
- Case: Lineær programmering.
Projektrapport af: Morten Blomhøj, Klavs Frisdahl og Frank Mølgaard Olsen.
Vejledere: Mogens Brun Heefelt og Jens Bjørneboe.
- 76/84 "KERNEKRAFT I DANMARK?" - Et høringsvar indkaldt af miljøministeriet, med kritik af miljøstyrelsens rapporter af 15. marts 1984.
ENERGY SERIES No. 10
Af: Niels Boye Olsen og Bent Sørensen.
- 77/84 "POLITISKE INDEKS - FUP ELLER FAKTA?"
Opinionsundersøgelser belyst ved statistiske modeller.
Projektrapport af: Svend Åge Houmann, Keld Nielsen og Susanne Stender.
Vejledere: Jørgen Larsen og Jens Bjørneboe.
- 78/84 "JÆVNSTRØMSLEDNINGSEVNE OG GITTERSTRUKTUR I AMORFT GERMANIUM".
Specialrapport af: Hans Hedal, Frank C. Ludvigsen og Finn C. Physant.
Vejleder: Niels Boye Olsen.
- 79/84 "MATEMATIK OG ALMENDANNELSE".
Projektrapport af: Henrik Coster, Mikael Wennerberg Johansen, Povl Kattler, Birgitte Lydholm og Morten Overgaard Nielsen.
Vejleder: Bernhelm Booss.
- 80/84 "KURSUSMATERIALE TIL MATEMATIK B".
Af: Mogens Brun Heefelt.
- 81/84 "FREKVENSafhængig LEDNINGSEVNE I AMORFT GERMANIUM".
Specialrapport af: Jørgen Wind Petersen og Jan Christensen.
Vejleder: Niels Boye Olsen.
- 82/84 "MATEMATIK - OG FYSIKUNDERVISNINGEN I DET AUTOMATISEREDE SAMFUND".
Rapport fra et seminar afholdt i Hvidovre 25-27 april 1983.
Red.: Jens Højgaard Jensen, Bent C. Jørgensen og Mogens Niss.
- 83/84 "ON THE QUANTIFICATION OF SECURITY":
PEACE RESEARCH SERIES NO. 1
Af: Bent Sørensen
nr. 83 er p.t. udgået
- 84/84 "NOGLE ARTIKLER OM MATEMATIK, FYSIK OG ALMENDANNELSE".
Af: Jens Højgaard Jensen, Mogens Niss m. fl.
- 85/84 "CENTRIFUGALREGULATORER OG MATEMATIK".
Specialrapport af: Per Hedegård Andersen, Carsten Holst-Jensen, Else Marie Pedersen og Erling Møller Pedersen.
Vejleder: Stig Andur Pedersen.
- 86/84 "SECURITY IMPLICATIONS OF ALTERNATIVE DEFENSE OPTIONS FOR WESTERN EUROPE".
PEACE RESEARCH SERIES NO. 2
Af: Bent Sørensen.
- 87/84 "A SIMPLE MODEL OF AC HOPPING CONDUCTIVITY IN DISORDERED SOLIDS".
Af: Jeppe C. Dyre.
- 88/84 "RISE, FALL AND RESURRECTION OF INFINITESIMALS".
Af: Detlef Laugwitz.
- 89/84 "FUERNVARMEOPTIMERING".
Af: Bjarne Lillethorup og Jacob Mørch Pedersen.
- 90/84 "ENERGI I L.G - EN TEORI FOR TILRETTELÆGGELSE".
Af: Albert Chr. Paulsen.
-
- 91/85 "KVANTETEORI FOR GYMNASIET".
1. Lærervejledning
Projektrapport af: Biger Lundgren, Henning Sten Hansen og John Johansson.
Vejleder: Torsten Meyer.
- 92/85 "KVANTETEORI FOR GYMNASIET".
2. Materiale
Projektrapport af: Biger Lundgren, Henning Sten Hansen og John Johansson.
Vejleder: Torsten Meyer.
- 93/85 "THE SEMIOTICS OF QUANTUM - NON - LOCALITY".
Af: Peder Voetmann Christiansen.
- 94/85 "TREENIGHEDEN BOURBAKI - generalen, matematikeren og ånden".
Projektrapport af: Morten Blomhøj, Klavs Frisdahl og Frank M. Olsen.
Vejleder: Mogens Niss.
- 95/85 "AN ALTERNATIV DEFENSE PLAN FOR WESTERN EUROPE".
PEACE RESEARCH SERIES NO. 3
Af: Bent Sørensen
- 96/85 "ASPEKTER VED KRAFTVARMEFORSYNING".
Af: Bjarne Lillethorup.
Vejleder: Bent Sørensen.
- 97/85 "ON THE PHYSICS OF A.C. HOPPING CONDUCTIVITY".
Af: Jeppe C. Dyre.
- 98/85 "VALGMULIGHEDER I INFORMATIONSSALDEREN".
Af: Bent Sørensen.
- 99/85 "Der er langt fra Q til R".
Projektrapport af: Niels Jørgensen og Mikael Klintorp.
Vejleder: Stig Andur Pedersen.
- 100/85 "TALSYSTEMETS OPBYGNING".
Af: Mogens Niss.
- 101/85 "EXTENDED MOMENTUM THEORY FOR WINDMILLS IN PERTURBATIVE FORM".
Af: Ganesh Sengupta.
- 102/85 OPSTILLING OG ANALYSE AF MATEMATISKE MODELLER, BELYST VED MODELLER OVER KØERS FODEROPTAGELSE OG - OMSÆTNING".
Projektrapport af: Lis Eilertzen, Kirsten Habekost, Lill Røn og Susanne Stender.
Vejleder: Klaus Grünbaum.

- 103/85 "ØDSLE KOLDKRIGERE OG VIDENSKABENS LYSE IDEER".
Projektrapport af: Niels Ole Dam og Kurt Jensen.
Vejleder: Bent Sørensen.
- 104/85 "ANALOGREGNEMASKINEN OG LORENZLIGNINGER".
Af: Jens Jøger.
- 105/85 "THE FREQUENCY DEPENDENCE OF THE SPECIFIC HEAT OF THE GLASS REANSITION".
Af: Tage Christensen.
- "A SIMPLE MODEL OF AC HOPPING CONDUCTIVITY".
Af: Jeppe C. Dyre.
Contributions to the Third International Conference on the Structure of Non - Crystalline Materials held in Grenoble July 1985.
- 106/85 "QUANTUM THEORY OF EXTENDED PARTICLES".
Af: Bent Sørensen.
- 107/85 "EN MYG GØR INGEN EPIDEMI".
- flodblindhed som eksempel på matematisk modellering af et epidemiologisk problem.
Projektrapport af: Per Hedegård Andersen, Lars Boye, Carsten Holst Jensen, Else Marie Pedersen og Erling Møller Pedersen.
Vejleder: Jesper Larsen.
- 108/85 "APPLICATIONS AND MODELLING IN THE MATHEMATICS CURRICULUM" - state and trends -
Af: Mogens Niss.
- 109/85 "COX I STUDIETIDEN" - Cox's regressionsmodel anvendt på studenteroplysninger fra RUC.
Projektrapport af: Mikael Wønnenberg Johansen, Poul Kattler og Torben J. Andreassen.
Vejleder: Jørgen Larsen.
- 110/85 "PLANNING FOR SECURITY".
Af: Bent Sørensen
- 111/85 "JORDEN RUNDT PÅ FLADE KORT".
Projektrapport af: Birgit Andresen, Beatriz Quinones og Jimmy Staal.
Vejleder: Mogens Niss.
- 112/85 "VIDENSKABELIGGØRELSE AF DANSK TEKNOLOGISK INNOVATION FREM TIL 1950 - BELYST VED EKSEMPLER".
Projektrapport af: Erik Odgaard Gade, Hans Hedal, Frank C. Ludvigsen, Annette Post Nielsen og Finn Physant.
Vejleder: Claus Bryld og Bent C. Jørgensen.
- 113/85 "DESUSPENSION OF SPLITTING ELLIPTIC SYMBOLS 11".
Af: Bernhelm Booss og Krzysztof Wojciechowski.
- 114/85 "ANVENDELSE AF GRAFISKE METODER TIL ANALYSE AF KONFIGURATIONSTABELLER".
Projektrapport af: Lone Billmann, Ole R. Jensen og Arne-Lise von Moos.
Vejleder: Jørgen Larsen.
- 115/85 "MATEMATIKKENS UDVIKLING OP TIL RENESSANCEN".
Af: Mogens Niss.
- 116/85 "A PHENOMENOLOGICAL MODEL FOR THE MEYER-NELDEL RULE".
Af: Jeppe C. Dyre.
- 117/85 "KRAFT & FJERNVARMOPTIMERING".
Af: Jacob Mørch Pedersen.
Vejleder: Bent Sørensen
- 118/85 "TILFÆLDIGHEDEN OG NØDVENDIGHEDEN IFØLGE PEIRCE OG FYSIKKEN".
Af: Peder Voetmann Christiansen
- 120/86 "ET ANVAL STATISTISKE STANDARDMODELLER".
Af: Jørgen Larsen
- 121/86 "STIMULATION I KONTINUERT TID".
Af: Peder Voetmann Christiansen.
- 122/86 "ON THE MECHANISM OF GLASS IONIC CONDUCTIVITY".
Af: Jeppe C. Dyre.
- 123/86 "GYMNASIEFYSIKKEN OG DEN STORE VERDEN".
Fysiklærerforeningen, IMFUA, RUC.
- 124/86 "OPGAVESAMLING I MATEMATIK".
Samtlige opgaver stillet i tiden 1974-jan. 1986.
- 125/86 "UVBYG - systemet - en effektiv fotometrisk spektral-klassifikation af B-, A- og F-stjerner".
Projektrapport af: Birger Lundgren.
- 126/86 "OM UDVIKLINGEN AF DEN SPECIELE RELATIVITETSTEORI".
Projektrapport af: Lise Odgaard & Linda Szkotak Jensen
Vejledere: Karin Beyer & Stig Andur Pedersen.
- 127/86 "GALOIS' BIDRAG TIL UDVIKLINGEN AF DEN ABSTRAKTE ALGEBRA".
Projektrapport af: Pernille Sand, Heine Larsen & Lars Frandsen.
Vejleder: Mogens Niss.
- 128/86 "SMÅRYB" - en ikke-standard analyse.
Projektrapport af: Niels Jørgensen & Mikael Klintorp.
Vejleder: Jeppe Dyre.
- 129/86 "PHYSICS IN SOCIETY"
Lecture Notes 1983 (1986)
Af: Bent Sørensen
- 130/86 "Studies in Wind Power"
Af: Bent Sørensen
- 131/86 "FYSIK OG SAMFUND" - Et integreret fysik/historie-projekt om naturanskuelsens historiske udvikling og dens samfundsmæssige betingethed.
Projektrapport af: Jakob Heckscher, Søren Brønd, Andy Wierød.
Vejledere: Jens Høyrup, Jørgen Vogelius, Jens Højgaard Jensen.
- 132/86 "FYSIK OG DANNEELSE"
Projektrapport af: Søren Brønd, Andy Wierød.
Vejledere: Karin Beyer, Jørgen Vogelius.
- 133/86 "CHERNOBYL ACCIDENT: ASSESSING THE DATA. ENERGY SERIES NO. 15.
AF: Bent Sørensen.
-
- 134/87 "THE D.C. AND THE A.C. ELECTRICAL TRANSPORT IN AsSeTe SYSTEM"
Authors: M.B.El-Den, N.B.Olsen, Ib Høst Pedersen, Petr Viscor
- 135/87 "INTUITIONISTISK MATEMATIKS METODER OG ERKENDELSESTEORETISKE FORUDSÆTNINGER"
MATEMATIKSPECIALE: Claus Larsen
Vejledere: Anton Jensen og Stig Andur Pedersen
- 136/87 "Mystisk og naturlig filosofi: En skitse af kristendommens første og andet møde med græsk filosofi"
Projektrapport af Frank Colding Ludvigsen
Vejledere: Historie: Ib Thiersen
Fysik: Jens Højgaard Jensen
- 137/87 "HOPMODELLER FOR ELEKTRISK LEDNING I UORDNEDE FASTE STOFFER" - Resume af licentiatforhandling
Af: Jeppe Dyre
Vejledere: Niels Boye Olsen og Peder Voetmann Christiansen.
- 119/86 "DET ER GANSKE VIST - - EUKLIDS FEMTE POSTULAT KUNNE NOK SKABE RØRE I ANEDAMMEN".
Af: Iben Maj Christiansen
Vejleder: Mogens Niss.

TEKST NR 144

1987

**Context and Non-Locality
– A Peircean Approach.**

Paper presented at the
Symposium on the Foundations of Modern Physics
The Copenhagen Interpretation
60 Years after the Como Lecture.
Joensuu, Finland, 6 – 8 august 1987.

Peder Voetmann Christiansen
Institute of Mathematics and Physics
Roskilde University Center
P.O. Box 260, DK 4000 Roskilde
Denmark

TEKSTER fra

IMFUFA

ROSKILDE UNIVERSITETSCENTER
INSTITUT FOR STUDIET AF MATEMATIK OG FYSIK SAMT DERES
FUNKTIONER I UNDERVISNING, FORSKNING OG ANVENDELSER

IMFUFA, Roskilde Universitetscenter, Postbox 260, 4000 Roskilde

Context and Non-Locality - A Peircean Approach.

by: Peder Voetmann Christiansen

IMFUFA tekst nr. 144/87 29 pages

ISSN 0106-6242

ABSTRACT

The aim of the Copenhagen interpretation of quantum mechanics is to provide a semantics for the symbols of the mathematical formalism. Niels Bohr's early philosophy which has a direct connection with his later ideas of complementarity is inspired both by danish existentialism and american pragmatism. The founder of pragmatism, C.S.Peirce, was, however, not known to Bohr, and Peirce's complete classification of non-linguistic signs has never been considered in connection with the Copenhagen-semantics, which is therefore in certain respects incomplete. In this paper it will be argued that Peirce's semiotic is a natural basis for quantum-semantics and that his "synechistic" concept of local realism can be tested experimentally. This opens a possibility of avoiding some of the extravagant ontological interpretations that have emerged in later years in consequence of the experimentally observed violations of Bell's inequalities.

For the edition of this paper as an IMFUFA-text two appendices have been added given pictorial derivations of some of the more formalistic points. Appendix A considers Peirce's logic of relations and his triadic doctrine of categories for the purpose of a general classification of signs. Appendix B discusses the derivation of Bell's inequalities from the classical calculus of logic without introducing local hidden variables.

CONTENTS.

Introduction.	p. 3
Høffding, and the years of Ecliptica.	p. 5
What went wrong in Copenhagen?	p. 8
The irreducible sign relation.	p. 14
Contextuality and Bell's inequalities.	p. 19
References.	p. 20
Appendix A. Peirce's classes of signs.	p. 22
Appendix B. The Bell - Santos inequalities.	p. 26

The Copenhagen interpretation is often regarded as identical with the pure mathematical formalism and many textbooks nowadays neglect the epistemological questions that were so important before the formalism got its final shape in the late twenties. This neglect of philosophical questions may be partly due to Bohrs attitude in his later years where he emphasized that ordinary language is insufficient and even misleading and that it must be replaced by the mathematical formalism. This attitude seems to have been connected with scepticism towards philosophy in general, at least it has been interpreted in this way by philosophers of a somewhat positivistic inclination who tend to disregard the important role of philosophy as inspirator for new developments in physics¹.

However, in his younger years Bohr was very engaged in philosophical speculations, and there is a strong historical evidence² indicating that the philosophy of complementarity was evolved long before quantum mechanics and is influenced by several streams of philosophy as focused by Bohrs philosophical teacher Harald Høffding. Max Jammer³ has pointed out the influence from the danish existentialist Søren Kierkegaard as important for an understanding of Bohr's ideas of the quantum jumps, and Witt-Hansen⁴ has drawn attention to the continuity-thinking of Leibniz, as mediated by Høffding, which seems closely connected with Bohr's correspondence-principle.

In this paper we shall look upon the influence from american pragmatism as exposed by William James (and Høffding) and the regrettable lack of influence from its originator, Charles S. Peirce, who was unknown to Bohr and has been neglected by and large in this century, until quite recently. The author's interest in these questions of history of philosophical influences on quantum mechanics is

not so much connected to historical philosophy as to the conviction that the difficulties of interpretation that confront quantum mechanics nowadays, especially after the Aspect-experiments, are real and serious and concerning semantics, not the mathematical formalism.

Many weird ontologies, involving backwards causality, splitting universes, telepathic synchronicity, or just a plain old-fashioned pre-established non-local harmony are invoked in these years in order to explain the observed violations of Bell's inequalities. The author believes that such ontologies, although some of them are interesting and may be valuable in other contexts, have nothing to do with quantum mechanics, which is a simple and logical theory with the very limited scope of explaining elementary phenomena of the atomic world in a consistent way.

It will be argued that, according to Peirce, a local realism is not identical with the existence of local hidden variables and therefore not automatically leading to Bell's inequalities. The Aspect experiments are convincing proofs of the validity of the quantum formalism under the circumstances set in the laboratory, and, although some weak loopholes remain, they may be regarded as counterproofs of theories of local hidden variables. This does not mean, however, that the concept of local realism, or Einstein-separability, has been disproved. The "synechistic" sort of local realism, as proposed by Peirce, has never been subjected to an experimental test, although it could easily be by a small alteration that would bring the experiments in closer relation to the thought experiment proposed by Einstein, Podolski and Rosen. Until now the experiments have just pointed to the need for a semiotic reconsideration of the quantum formalism but cannot be taken as evidence for the validity of extravagant ontologies.

HØFFDING, AND THE YEARS OF ECLIPTICA.

Niels Bohr began the study of physics at the Copenhagen University in the year 1903. At that time all students were initiated to the academic world through an introductory course in "propedeutic philosophy". The professor of philosophy, Harald Høffding, was an old friend of Bohr's father and had been a frequent guest in their home where lively discussions of science, philosophy and politics took place. Niels and his brother Harald were thus well prepared to take part in a continuation of the cross-cultural spirit of Copenhagen from "the golden age" in the 19th century. The fertile ground created by such giants as N.F.S.Grundtvig and S.Kierkegaard was still blossoming at the turn of the century with a new poetic realism and impressionism in the literature and a cultural radicalism in philosophy and politics, opposed to the dictatorial conservative Estrup government and with Høffding and the brothers Brandes as leading figures.

In the autumn of 1904 Høffding made a journey to USA and England. After having returned full of new ideas he started a series of philosophical colloquia at the university. A group of 12 students attending these colloquia, among them Niels and Harald Bohr, formed a circle called Ecliptica with the purpose of further discussions of the philosophical topics that Høffding called their attention to. We have no detailed written reports of the discussions at these meetings, but we know that the atmosphere was stimulating, although heavily polluted with tobacco smoke. Not less than three internationally recognized "Copenhagen schools" have emerged from this small circle, viz. Niels Bohr's in physics, Edgar Rubin's in

psychology, and Viggo Brøndal's (and Louis Hjelmslev's) structural linguistics.

One of the Copenhagen philosophers of the 19th century that must have played a great role in the discussions is Søren Kierkegaard, a highly religious thinker who exhausted himself in violent attacks against the established church. Høffding was an expert in Kierkegaard's philosophy and considered his existentialistic writings on the choice and "the qualitative jump" to be of importance far outside theology, in the general logic of concepts and psychology. Kierkegaard was very critical against Hegel's dialectical philosophy, especially the thesis of quantity turning over into quality. In several books from around 1845, e.g. "Begrebet Angest" (The Concept of Dread) he analyzes the free choice as something that cannot be reduced or explained away by quantitative means. The choice is a qualitative jump confronting the subject with a vacuum that creates dizziness, nausea and dread. Kierkegaard employs a peculiar circular or "bootstrapping" logic in describing the jump, which is said to be a choice between possibilities that are presupposed or preset by the jump. Høffding's first series of colloquia in the spring of 1905 were discussions of the concept of free will and Kierkegaard's ideas must have had a central place. Niels Bohr has in several letters from 1909 reported how his own readings of Kierkegaard made a deep impression on him, and it is rather easy to see how many of his more cryptic remarks on complementarity bear a close resemblance to Kierkegaard's formulations.

Another important influence on Bohr's thinking in the early years of Ecliptica comes from America, viz. William James. During his stay in USA in the autumn 1904 Høffding had been the guest of William James and in his memoirs⁵ he describes what great inspiration the contact with James had

been to him. In an interview given to Thomas Kuhn and Aage Petersen¹ the day before his death Bohr tells that he read William James in his young years and that James' description of "the stream of consciousness" had made a lasting impression on him.

Besides being a pioneer of depth-psychology James is also considered the founder of the pragmatic school of philosophy. This school is founded on the so called pragmatic criterion of meaning which is closely related to Bohr's semantic thesis that the meaning of the quantum mechanical symbols is set by the experimental context. James himself, however, did not consider himself the inventor of pragmatism but pointed to his old friend Charles Sanders Peirce who had first formulated the pragmatic criterion of meaning in a paper "How to make our ideas clear" from 1878. There is no indication that Høffding or Bohr knew anything of Peirce's philosophy, but there is an indirect connection so far as James' influence is important and is inspired by a life-long acquaintance with Peirce.

Another indication of an indirect connection from Peirce to Bohr is found in the fact that Høffding after his stay in America went to England in the late autumn of 1904 where he stayed as a guest in the house of another of Peirce's close friends, the Lady Victoria Welby. A great part of Peirce's general theory of signs, semiotic, is evolved in letters to Lady Welby who herself had made original contributions to the theory of semantics. Peirce is known to have warned Lady Welby "perhaps you are in danger of falling into some error in consequence of limiting your studies so much to language"⁶. Unfortunately, this warning never went through to Bohr who remained "suspended in language"⁷.

WHAT WENT WRONG IN COPENHAGEN?

In his discussions with Einstein at the Solvay meetings 1927-30 Bohr maintained the pragmatic attitude that the meaning of the symbols for position and momentum is set by the apparatus of measurement which itself is subject to the fluctuations described in Heisenberg's uncertainty relations. These fluctuations are thus inherent in the quantum mechanical semiosis, and we are not allowed to say that some "true" values are "disturbed" by the measurement process, because true values are created by the measurement and must not in general be assumed to exist by themselves in nature. This is all very much in accordance with Peirce's epistemology as described in an article from 1892⁸. Peirce would also agree with Bohr in the view that physicists must allow God the freedom to play dice. This view, that chance is a genuine and irreducible factor in the physical universe was advocated as "tychism" in the above mentioned article.

Einstein tried at the Solvay meetings to demonstrate that quantum mechanics was inconsistent, i.e. that it contained an intrinsic logical flaw that would turn up in situations clearly within the scope of the theory. However, after 1930 he seems to have been convinced of its consistency within a limited field. His next attack, in 1935 with Podolski and Rosen⁹, is an attempt to demonstrate the incompleteness of the theory, i.e. that there are real situations where the theory cannot be applied or where it would lead to false predictions if one tried to apply it. In the light of Gödel's incompleteness theorem from 1931 the accusation of being incomplete would not seem so serious, because in mathematics this property is a necessary consequence of the consistency of the theory. Probably Einstein thought that the situation was analogous in

physics, although he did not refer to Gödel's theorem. He had at that time just obtained a permanent position in Princeton and was joined by Gödel shortly afterwards.

In Copenhagen, however, the distinction between consistency and completeness was hardly noticed. L. Rosenfeld who took dictations from Bohr in his reply to Einstein, Podolski and Rosen (EPR) has in the memorial volume "Niels Bohr"¹⁰ given a vivid report on the efforts which leaves the impression that Bohr was trying to live up to his image as the great champion of the fights with Einstein rather than trying to understand in what respects the EPR paper presented a new viewpoint. Consider, for example the following quotation from Rosenfeld's report (my translation from danish):

"Day after day, week after week the whole argumentation was patiently investigated by means of simpler and more transparent examples. Einstein's problem was reshaped and its solution formulated again with such precision and clarity that the weakness in the reasoning of the critics became evident and their whole argumentation, in spite of all its fake spirituality, was shattered to pieces. "They do it nicely," was Bohr's comment, "but what counts is to do it correctly"."

The myth about the "precision and clarity" of Bohr's reply to EPR¹¹ does not stand for a closer scrutiny. Einstein never understood it and consequently the debate came to a stalemate. J.S.Bell has declared¹² that Bohr's reply is "totally obscure" and similar but more vague declarations of uneasiness have been issued by Dirac and Feynmann. Even Bohr himself had to admit when he reread the paper in 1949 that he "strongly felt the inadequacy of expression"¹³. It is not the entire article that is obscure but a definite place that Bohr and Bell are referring to.

In the first part of the article Bohr pursues the line of argumentation that had proven so successful in the Solvay discussions:

" The finite interaction between the object and the measuring agencies conditioned by the very existence of the quantum of action entails - because of the impossibility of controlling the reaction of the object on the measuring instruments if these are to serve their purpose - the necessity of a final renunciation of the classical ideal of causality and a radical revision of our attitude towards the problem of physical reality."

This is still a physical way of reasoning and it does not exclude a realistic attitude but just a semiotically unreflected sort of realism that would ascribe definite numerical values to quantities of the undisturbed reality. There is a strong resemblance between the Bohr-quotation above and the way Peirce argues against "the doctrine of necessity" in 1892⁸ (but of course Peirce does not mention the quantum of action):

"Try to verify any law of nature and you will find that the more precise your observations, the more certain they will be to show irregular departures from the law. We are accustomed to ascribe these, and I do not say wrongly, to errors of observation; yet we cannot usually account for such errors in any antecedently probable way. Trace their causes back far enough, and you will be forced to admit they are always due to arbitrary determination, or chance."

In connection with this view on observations in general Peirce criticizes "the necessitarian position - that certain continuous quantities have exact values" and concludes that "any statement to the effect that a certain continuous

quantity has an exact value, if well-founded at all, must be founded on something other than observation." In short: Bohr and Peirce agree that the analysis of the measurement process calls for a semiotic reconsideration of our notions of the undisturbed physical reality, but Bohr's argument is ontological, based on the existence of the quantum of action, whereas Peirce's argument is epistemological and based on our inability to account for errors of measurements "in any antecedently probable way". One may conjecture that Peirce, had he known about the quantum of action, would have supported Bohr's argument wholeheartedly.

However, in the later part of Bohr's reply to EPR there is a sudden turning away from the, still potentially realistic, attitude in the first quotation. This is the exact place where the article becomes obscure (both according to Bell and Bohr). In discussing the EPR thought experiment where a measurement on one particle can be said to affect the state of another particle Bohr writes:

"Of course there is in a case like that just considered no question of a mechanical disturbance of the system under investigation during the last critical stage of the measurement procedure. But even at this stage there is essentially the question of an influence on the very conditions which define the possible types of predictions regarding the future behavior of the system ."

This is almost certainly a place where Peirce would have objected, because Bohr tries to circumvent both realism (anti-nominalism) and synechism, i.e. the conception that signs exist outside the subjective mind and propagate through a continuum.

It is not clear what connection there could be between the "finite interaction" in the first Bohr-quotation and the

"very conditions" in the second. When we make a measurement on particle 1 we have a free choice of measuring one or the other of two complementary properties of this particle, e.g. position or momentum. The choice between the two different ways of interacting with particle 1 according to Bohr prohibits the use of the EPR-term "the same reality" for particle 2, even though this particle is not affected by any mechanical disturbance, and this is because quantum mechanics forces us to regard the whole phenomenon of preparation and measurement as possessing an "individuality completely foreign to classical physics". The "very conditions" in the second quotation thus seems to be the formalism of quantum mechanics associated with the philosophy of complementarity, and Bohr is trying to persuade the reader to accept that quantum mechanics defines how the term "physical reality" may be correctly used. This is of course difficult to accept from a realistic standpoint: when the question is whether the quantum mechanical description of physical reality is complete, then the answer that quantum mechanics itself defines what "physical reality" is looks like a philosophical shortcircuit or cheating in the game of debate.

Apart from breaking with realism, the introduction of the "very conditions" also breaks with the locality principle, or synechism. When we measure one or the other of the two complementary properties of particle 1 without disturbing particle 2 then it is true that quantum mechanics gives an unambiguous prediction for the future behavior of particle 2, viz. a wave function corresponding to a pure state of that particle. The "finite interaction" is in this case only involving particle 1, but it produces via the "very conditions" a change of state of particle 2. Bohr seems to forget that we still have the possibility of making

an independent measurement on particle 2 and that this would amount to a test of the formalism that can be performed whether one accepts the influence via the "very conditions" or not. What about the "finite interaction" with particle 2 that would be introduced by such a second measurement? Can we be sure that it doesn't produce a conflict with the "very conditions" if the two measurements really are physically independent ? These questions are unanswered in Bohr's article.

According to the orthodox Copenhagen interpretation (after 1935) one is really not allowed to ask such questions. Rosenfeld, as the guardian of the orthodoxy, states¹⁰ that "the refusal of Einstein's criticism does not add any new element to the concept of complementarity". The rest is silence in Copenhagen. Attempts to formulate a realistic concept of the quantum world have been met with cryptic formulations stressing both that we are suspended in language, that the language is inadequate, and that our problem is to use the language correctly, which in most cases mean to abstain from the use of words and stick to the mathematical formalism, or to quote Bohr directly.

The author believes that the orthodoxy after 1935 is due to the fact that nobody (including Bohr himself) ever understood what the "very conditions" are. Something went wrong in Copenhagen in the very moment they were introduced. Until then the Copenhagen interpretation had pursued the reasonable goal of creating a "minimal semantics" as v. Weizsäcker states it, but afterwards even that task became impossible, because the "very conditions" create the illusion that the mathematical formalism makes up reality instead of describing it. A reconstruction of the original goal is very much needed nowadays, because the experimental violation of Bell's inequalities has created confusion.

THE IRREDUCIBLE SIGN RELATION.

Following now the line of thought that the missing link in the minimal semantics of the Copenhagen interpretation is

1) a way to include the concept of non-linguistic signs of an undisturbed physical reality in the formalism, and

2) a description of conditions for their transformation to symbolic results of measurements,

we shall see how this may be done with the use of Peirce's general theory of signs, semiotic.

The first part of this program is in fact already achieved by Dirac with his introduction of the "kets" and the "bras", the concept of a state vector without reference to representation. With Peirce's terminology the ket is an example of a "degenerate" type of sign called an index and the representation is an interpretant which in combination with the index creates a non-degenerate sign, a symbol (the bra-ket).

The second part amounts to a proper theory of measurement, and this is not easily achieved, but one may hope that Peirce's idea of continuity and connectedness of sign relations, synechism, which were first expressed in a paper from 1892¹⁴, may add some simple criteria of connectedness as a necessary condition for a measurement apparatus to constitute an interpretant in a quantum-semiotic sign relation. At least this consideration points to the relevance of the connectedness of Aspect's equipment, the use of coincidence counters, to the contextuality of the measured polarizations, i.e. the non-locality exhibited by the violation of Bell's inequalities.

The application of Peirce's ideas to quantum mechanics of course requires some reshaping of concepts and cannot be

totally faithful to the original formulations. This is, however, not as bad as it may sound. Peirce, unlike Hegel, never created a completed system, and his aim was to develop scientific methods that could be applied by future researchers in an unending development. His own development of semiotic is a good example, it is easy to find contradicting statements in his writings, but his ideas are continually gaining in integrity and generality, and from about 1885 to his death in 1914 they seem free of contradictions. It is not necessary to read everything he wrote in order to use his ideas (which would be impossible, as he wrote about 80.000 pages), a few hints are sufficient in order to grasp the method, and from there one may proceed according to need of new development. The best starting point is the logic of relations and the triadic doctrine of categories. These concepts lead in a rigorous way to hierarchical systems of sign-classification that very soon become general enough to encompass all conceivable types of signs. A very useful classification based on a twofold application of the triadic categories (with some "selection rules") gives ten classes of signs¹⁵. This is already too much for our purpose; as long as we are mainly interested in the way the sign refers to the object a single trichotomy is sufficient.

Peirce's triadic doctrine of categories is based on the observation that a network of relations in more than one dimension requires at least triadic relations. On the other hand it can be shown that relations of order higher than three always can be reduced to triadic relations. A sign is defined as a genuine triadic relation involving

1. A primary sign or sign vehicle.
2. An object.
3. An interpretant.

REFERENCES.

1. Favrhøldt, D., Danish Yearbook of Philosophy, 13 , 206 (1976).
2. Faye, J., "The Bohr-Høffding Relationship Reconsidered", Preprint (1987), Institute of Mathematics and Physics, Roskilde University Center, P.O. Box 260, DK 4000, Roskilde.
3. Jammer, M., The Conceptual Development of Quantum Mechanics , McGraw-Hill, London (1966), pp 172-173.
4. Witt-Hansen, J., Danish Yearbook of Philosophy, 17 , 31 (1980).
5. Høffding, H., Erindringer , Gyldendal, København (1928), pp. 202-214.
6. Lieb, I. C., Charles S. Peirce's Letters to Lady Welby . New Haven, Conn. (1953), p. 39.
7. Petersen, Aa., Quantum Physics and the Philosophical Tradition . M.I.T. Press (1968), p. 188.
8. Peirce, C.S., The Monist, II , 321 (1892), pp. 328-329
9. Einstein, A., Podolsky, B., and Rosen, N., Phys. Rev., 47 , 777 (1935).
10. Rosenfeld, L., in Niels Bohr , J.H.Schultz Forlag, København (1964), p. 124.
11. Bohr, N., Phys. Rev. 48 , 696 (1935).
12. J.S.Bell in an interview in the film "Atomfysik og Virkelighed" by Lars Becker-Larsen, Statens Filmcentral, København (1985).
13. Bohr, N., Atomfysik og Menneskelig Erkendelse , J.H. Schultz, København (1957), p. 76.
14. Peirce, C.S., The Monist, II , 534 (1892).
This paper, "The Law of Mind" as well as ref. 8, "The Doctrine of Necessity Examined" can be found (slightly abbreviated) in the "Collected Papers", and in:

- Buchler, J., Philosophical Writings of Peirce , Dover, N.Y. (1955).
15. Short, T.L., *Semiotica*, 60 , 103 (1986).
 16. Callen, H.B., and Welton, T.A., *Phys. Rev.* 83 , 34 (1951).
 17. Rayski, J., Proc. 2nd Int. Symp. Foundations of Quantum Mechanics , Tokyo (1986), pp. 282-286.
 18. Christiansen, P.V., Text no. 93 (1985), IMFUFA, Roskilde University Center.
 19. Primas, H., "Contextual Quantum Objects and Their Ontic Interpretation", abstract/paper delivered at this conference, Joensuu, august 1987.
 20. Bell, J.S., *Physics*, 1 , 195 (1965).
 21. Santos, E., *Phys. Letters*, A 115 , 363, (1986).
 22. Aspect, A., and Grangier, P., Proc. Int. Symp. Foundations of Quantum Mechanics , Tokyo (1983), pp. 214-224.

APPENDIX A.
PEIRCE'S CLASSES OF SIGNS.

Peirce's semiotic is based on the logic of relations. In fig. 1 we look upon some of the most important observations in this discipline using a diagrammatic method known as bond graphs, where the relations are depicted as nodes and the constituent signs as branches of a network.

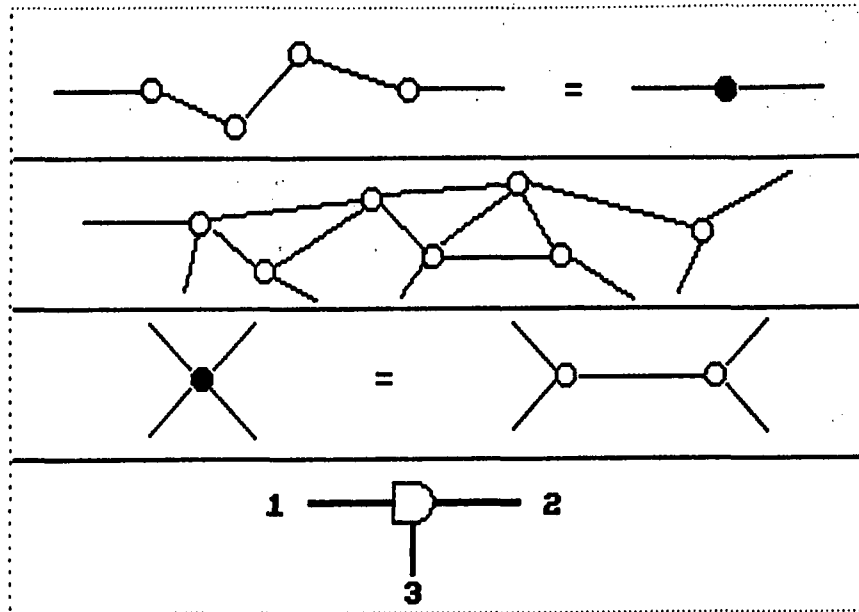

Fig. 1 . Bond graphs illustrating logic of relations.

Reading the figure from the top, the first illustration shows that a combination of dyadic relations, i.e. relations between two signs always lead to a new dyadic relation. These relations belong to a one-dimensional logic, but are not sufficient to build a general network. The next illustration from above shows that a network in more than one dimension has to include triadic relations or higher, corresponding to nodes connecting at least three branches.

The third illustration shows that relations of higher order than three always can be reduced to triadic relations. Finally the last illustration shows an icon of a prototype of a genuine triadic, asymmetric relation, the sign relation. Although we say that relations are relations between signs the logic of Peirce states that a sign is a relation. The two concepts, sign and relation, define each other, just like, e.g. part and whole.

The sign relation connecting 1. The primary sign, 2. The object, and 3. The interpretant gives rise to the three ontological categories, as described in the text, p. 16. In Fig. 2 the three factors of the sign relation are shown as the three axes of a coordinate system, and on each axis three points are marked, corresponding to the three ontological categories, firstness nearest to the origin.

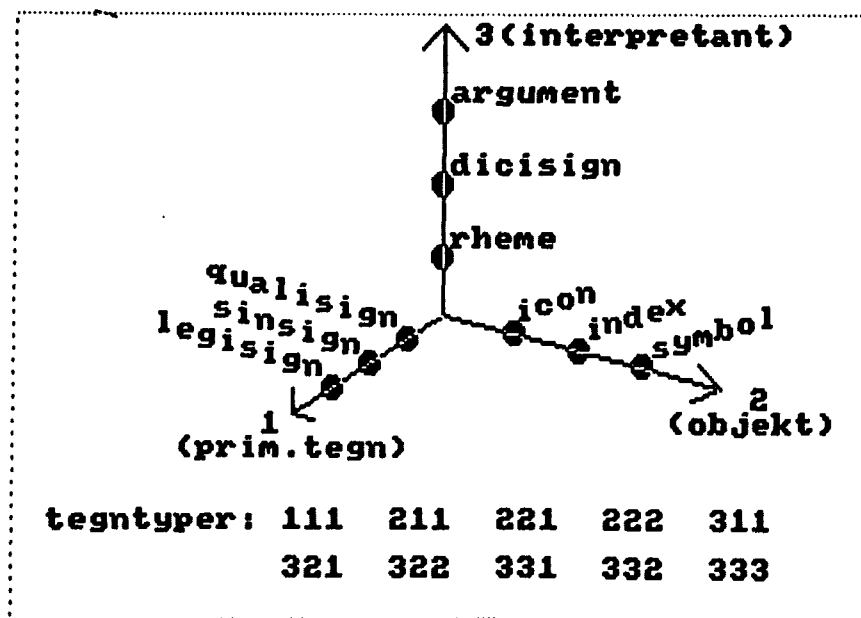

Fig. 2 . The classification of signs obtained by applying the ontological trichotomy to each of the three factors of the sign relation.

For the primary sign we get the three categories 1. qualisign, i.e. a pure quality (like the color red), 2. sinsign, a definite thing (like a particular red banner), and 3. legisign, a sign as representing a general class (like the banner of a trade union). For the object reference the trichotomy gives 1. icons, 2. indices, and 3. symbols, as discussed in the text, p. 16, and for the interpretant we get 1. rheme, or term, 2. dicisign, or proposition, and 3. argument.

These three tricotomies can be combined in 27 ways and all these possibilities can be depicted as points in 3-space. However, not all these 27 combinations correspond to legitimate sign-classes. There is a simple selection rule that may be formulated as follows:¹⁵

No lower order trichotomy can be applied to a lower place in the sign relation .

This means that an argument must be a symbolic legisign, a dicisign may be a symbolic legisign or an indexical legisign or an indexical sinsign, whereas a rheme may be a symbolic legisign, an indexical legisign, an indexical sinsign, an iconical legisign, an iconical sinsign or an iconical qualisign. All together there are ten classes of signs.

The reason why the selection rule is valid can be seen with a few simple examples: A symbol that refers to an object by some convention presupposes that the primary sign is considered as representing a general class, a legisign, e.g. in order to consider a red banner as a symbol of socialism we must know that such banners are used by trade unions for demonstrations on the first of may. In order to see the indexical reference of a banner to a particular trade union we must at least recognize it as a particular thing, a sinsign, and not just as "something red".

In quantum semiotic the most important trichotomy regards the object reference. A full, non-degenerate sign relation is needed in order to give birth to a symbol. The bonds in the sign relation of quantum semiotic must be regarded as interaction bonds of a concrete physical nature. Each bond connects two physical systems and describes an elementary interaction, system 1 acts on system 2 which acts back on system 1. In classical physics an interaction bond can be described with two symbolic variables, e.g. current and voltage, or velocity and force, such that the product of these variables gives the energy transfer per second, but in quantum mechanics no symbolic representation of these variables exist, because symbols presuppose a full sign relation of interaction bonds. The system theoretic description of the irreducible sign relation (p. 17) is illustrated on fig. 3.

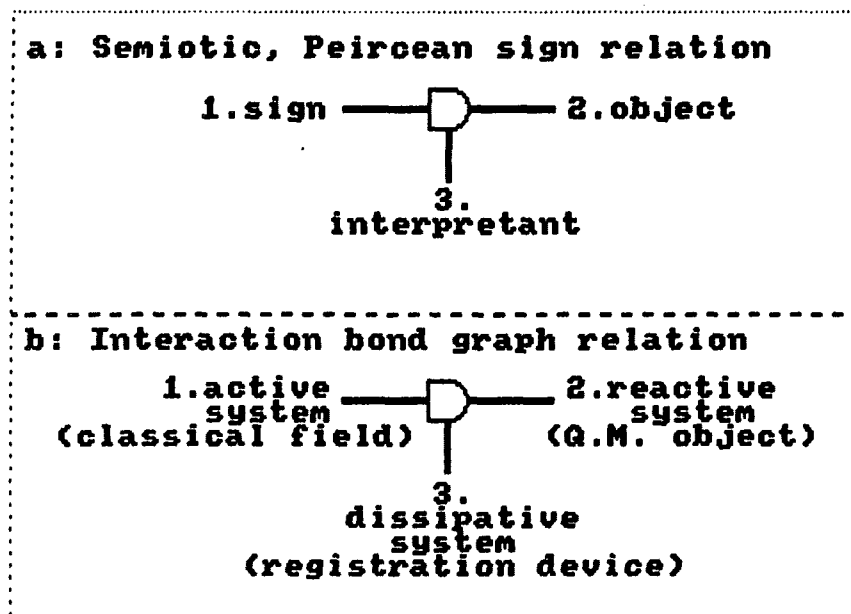

Fig. 3 . The sign relation, as described by Peirce, and in quantum semiotic.

APPENDIX B.
THE BELL - SANTOS INEQUALITIES.

The classical calculus of logic assumes that it is possible for arbitrary propositions, a and b , to form negations, $\neg a$, $\neg b$, conjunctions, $a \wedge b$, and disjunctions, $a \vee b$ according to the rules:

$$\neg(a \wedge b) = \neg a \vee \neg b ; \neg(a \vee b) = \neg a \wedge \neg b \quad (B1)$$

$$a \wedge (b \vee c) = (a \wedge b) \vee (a \wedge c) ; a \vee (b \wedge c) = (a \vee b) \wedge (a \vee c) \quad (B2)$$

so that the operations of conjunction and disjunction correspond to the forming of intersections, respectively unions of sets. Truth values of the propositions may then be generalized to probabilities, $p(a)$, in accordance with Kolmogorov's axioms, so that

$$p(\neg a) = 1 - p(a) \quad (B3)$$

$$p(a \vee b) = p(a) + p(b) - p(a \wedge b) \quad (B4)$$

These rules assume an absence of context, i.e. that the probability of a certain property, a , does not depend on whether another property, b , is being measured simultaneously. In quantum mechanics this assumption can only be satisfied for a set of mutually compatible properties, described by commuting operators. For a single particle this condition will be rather natural, because a proposition like $a \wedge b$ will be meaningless for complementary properties, like spin- x and spin- y , unless the experimental context is included in the propositions. For a two-particle system, however, we may find a set of properties, $a_1, b_1, -$

for particle 1, each of which being compatible with every one of a set of properties, a_1, a_2 , - for particle 2, so that propositions like $a_1 \wedge b_2$ are perfectly meaningful, regardless of context.

For such a system it has been shown by E. Santos²¹ that the rules of classical logic, (B1) - (B4), lead to the following inequalities:

$$0 \leq S(a_1, a_2) + S(a_1, b_2) + S(b_1, a_2) - S(b_1, b_2) \leq 2; \quad (B5)$$

where S is the "measure of separation":

$$S(a, b) = p(a) + p(b) - 2p(a \wedge b). \quad (B6)$$

Only the left inequality of (B5) is derived in Santos' paper, but the right one follows from the same formalism. Using the method of Venn-diagrams, in fig. 4 the measure of separation $S(a_1, a_2)$ is represented by the shaded areas.

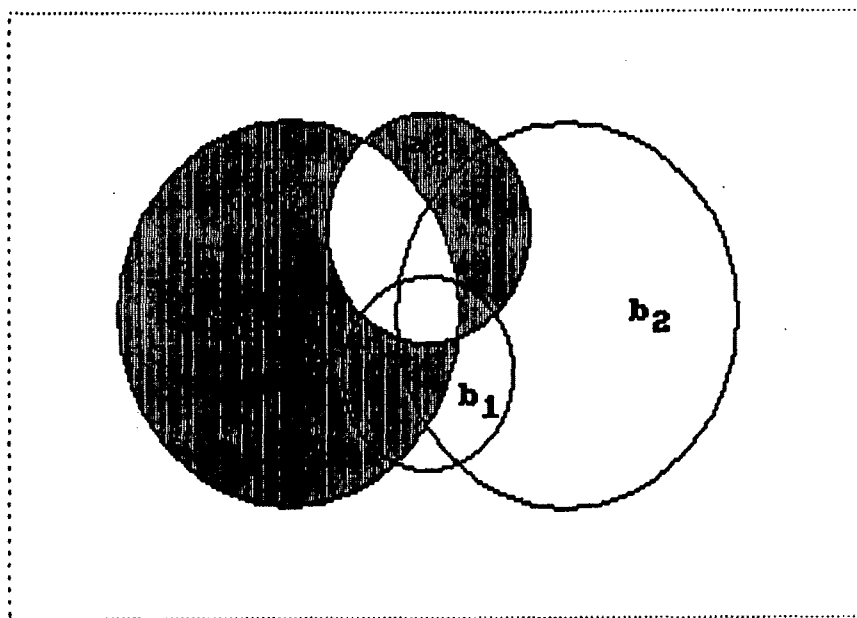

Fig. 4 Venn-diagram showing $S(a_1, a_2)$ as shaded area.

When we as in (B5) add three of the four separation measures combining a property of particle 1 with one of particle 2 and subtract the fourth we get the Venn-diagram of fig. 5. In this case all the shaded areas are counted twice, and as the total measure is unity we get the inequality (B5).

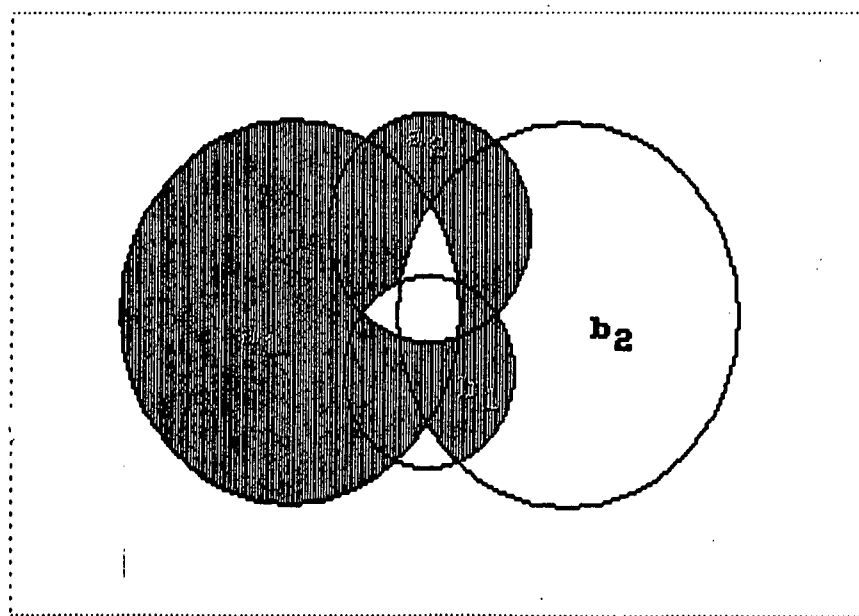

Fig. 5 . Venn-diagram illustrating the derivation of Santos' inequality (B5).

The use of Venn-diagrams for logical derivations presupposes the validity of the rules (B1) - (B4) so strictly speaking the diagrammatic proof of Santos' inequality assumes a total absence of contextuality. This condition cannot be fulfilled for properties of the same particle that are assumed to be non-compatible. However, the inequality only contains measures of separation between properties of two different particles, and it will therefore be valid when the properties of particle 1 are independent of the context of measurement for particle 2 and vice versa.

The inequalities (B5) are identical with Bell's inequalities as derived by Clauser and Horne (Phys. Rev. D 10, 526 (1974)). For an experiment like Aspect's first²², where the a's and b's are the propositions that a photon has been detected through a polarizer of a certain setting, we can translate inequalities (B5) introducing the coincidence probabilities by the assumption $p(a_i) = p(b_j) = \frac{1}{2}$:

$$1 \geq p(a_1 \wedge a_2) + p(a_1 \wedge b_2) + p(b_1 \wedge a_2) - p(b_1 \wedge b_2) \geq 0. \quad (B7)$$

For example, if the four polarizer-orientations are chosen such that b_1 and b_2 are measured in the same direction, whereas the other three directions form angles of 120° to each other, we find from the right inequality of (B7), that the coincidence probability for two different directions should be greater than or equal to $1/6$ (assuming that the coincidence probability is $\frac{1}{2}$ for parallel polarizers). Quantum mechanics, on the other hand gives the precise value $\frac{1}{2} \cdot \cos^2 120^\circ = 1/8$, a value that is confirmed by the Aspect-experiment, so there can be no doubt that (B7) is violated. This case is identical with the case discussed in the popular exposition by Mermin (Physics Today, april 1985) who, however, seems to forget that the actual experiments are made by connected pieces of apparatus, and that all the so called violation of local realism lies within the violation of the inequalities (B7), which involves only coincidence countings. (See, however, Mermin's reply to comments, Physics Today, november 1985). The claim that the connections are irrelevant for the observed non-locality or contextuality is not well founded and can only be proven/disproven experimentally by doing the experiment without connections. The author's conjecture is that the inequalities will be satisfied for such an experiment.

- 1/78 "TANKER OM EN PRAKSIS" - et matematikprojekt. Projekt rapport af: Anne Jensen, Lena Lindenskov, Marianne Kesselhahn og Nicolai Lomholt. Vejleder: Anders Madsen
- 2/78 "OPTIMERING" - Menneskets forøgede beherskelsesmuligheder af natur og samfund. Projekt rapport af: Tom J. Andersen, Tommy R. Andersen, Gert Kreinø og Peter H. Lassen. Vejleder: Bernhelm Boss.
- 3/78 "OPGAVESAMLING", breddekursus i fysik. Af: Lasse Rasmussen, Aage Bonde Kræmmer og Jens Højgaard Jensen.
- 4/78 "TRE ESSAYS" - om matematikundervisning, matematiklæreruddannelsen og videnskabsrindalismen. Af: Mogens Niss. Nr. 4 er p.t. udgået.
- 5/78 "BIBLIOGRAFISK VEJLEDNING til studiet af DEN MODERNE FYSIKS HISTORIE". Af: Helge Kragh. Nr. 5 er p.t. udgået.
- 6/78 "NOGLE ARTIKLER OG DEBATINDLÆG OM - læreruddannelse og undervisning i fysik, og - de naturvidenskabelige fags situation efter studenteroprøret". Af: Karin Beyer, Jens Højgaard Jensen og Bent C. Jørgensen.
- 7/78 "MATEMATIKKENS FORHOLD TIL SAMFUNDSØKONOMIEN". Af: B.V. Gnedenko. Nr. 7 er udgået.
- 8/78 "DYNAMIK OG DIAGRAMMER". Introduktion til energy-bond-graph formalismen. Af: Peder Voetmann Christiansen.
- 9/78 "OM PRAKSIS' INDFLYDELSE PÅ MATEMATIKKENS UD - VIKLING". - Motiver til Kepler's: "Nova Stereometria Doliorum Vinariorum". Projekt rapport af: Lasse Rasmussen. Vejleder: Anders Madsen.
-
- 10/79 "TERMODYNAMIK I GYMNASIET". Projekt rapport af: Jan Christensen og Jeanne Mortensen. Vejledere: Karin Beyer og Peder Voetmann Christiansen.
- 11/79 "STATISTISKE MATERIALER". Af: Jørgen Larsen.
- 12/79 "LINEÆRE DIFFERENTIALLIGNINGER OG DIFFERENTIALLIGNINGSSYSTEMER". Af: Mogens Brun Heefelt. Nr. 12 er udgået.
- 13/79 "CAVENDISH'S FORSØG I GYMNASIET". Projekt rapport af: Gert Kreinø. Vejleder: Albert Chr. Paulsen.
- 14/79 "BOOKS ABOUT MATHEMATICS: History, Philosophy, Education, Models, System Theory, and Works of". Af: Else Høyrup. Nr. 14 er p.t. udgået.
- 15/79 "STRUKTUREL STABILITET OG KATASTROFER i systemer i og udenfor termodynamisk ligevægt". Specialeopgave af: Lief S. Striegler. Vejleder: Peder Voetmann Christiansen.
- 16/79 "STATISTIK I KRÆFTFORSKNINGEN". Projekt rapport af: Michael Olsen og Jørn Jensen. Vejleder: Jørgen Larsen.
- 17/79 "AT SPØRGE OG AT SVARE i fysikundervisningen". Af: Albert Christian Paulsen.
- 18/79 "MATHEMATICS AND THE REAL WORLD", Proceedings of an International Workshop, Roskilde University Centre, Denmark, 1978. Preprint. Af: Bernhelm Booss og Mogens Niss (eds.)
- 19/79 "GEOMETRI, SKOLE OG VIRKELIGHED". Projekt rapport af: Tom J. Andersen, Tommy R. Andersen og Per H.H. Larsen. Vejleder: Mogens Niss.
- 20/79 "STATISTISKE MODELLER TIL BESTEMMELSE AF SIKRE DOSER FOR CARCINOGENE STOFFER". Projekt rapport af: Michael Olsen og Jørn Jensen. Vejleder: Jørgen Larsen
- 21/79 "KONTROL I GYMNASIET-FORMAL OG KONSEKVENSER". Projekt rapport af: Crilles Bacher, Per S.Jensen, Preben Jensen og Torben Nysteen.
- 22/79 "SEMIOTIK OG SYSTEMEGENSKABER (1)". 1-port lineært response og støj i fysikken. Af: Peder Voetmann Christiansen.
- 23/79 "ON THE HISTORY OF EARLY WAVE MECHANICS - with special emphasis on the role of reality". Af: Helge Kragh.
-
- 24/80 "MATEMATIKOPFATTELSE HOS 2.G'ERE". a+b 1. En analyse. 2. Interviewmateriale. Projekt rapport af: Jan Christensen og Knud Lindhardt Rasmussen. Vejleder: Mogens Niss.
- 25/80 "EKSAMENSOPGAVER", Dybdemodulet/fysik 1974-79.
- 26/80 "OM MATEMATISKE MODELLER". En projekt rapport og to artikler. Af: Jens Højgaard Jensen m.fl.
- 27/80 "METHODOLOGY AND PHILOSOPHY OF SCIENCE IN PAUL DIRAC'S PHYSICS". Af: Helge Kragh.
- 28/80 "DILEMTRISK RELAXATION - et forslag til en ny model bygget på væskernes viscoelastiske egenskaber". Projekt rapport af: Gert Kreinø. Vejleder: Niels Boye Olsen.
- 29/80 "ODIN - undervisningsmateriale til et kursus i differentiaalligningsmodeller". Projekt rapport af: Tommy R. Andersen, Per H.H. Larsen og Peter H. Lassen. Vejleder: Mogens Brun Heefelt.
- 30/80 "FUSIONSENERGIEN - - - ATOMSAMFUNDETS ENDESTATION". Af: Oluf Danielsen. Nr. 30 er udgået.
- 31/80 "VIDENSKABSTEORETISKE PROBLEMER VED UNDERVISNINGSSYSTEMER BASERET PÅ MÆNGDELÆRE". Projekt rapport af: Troels Lange og Jørgen Karrebæk. Vejleder: Stig Andur Pedersen. Nr. 31 er p.t. udgået.
- 32/80 "POLYMERE STOFFERS VISCOELASTISKE EGENSKABER - BELYST VED HJÆLP AF MEKANISKE IMPEDANSMÅLINGER MØSSBAUEREFFEKTMÅLINGER". Projekt rapport af: Crilles Bacher og Preben Jensen. Vejledere: Niels Boye Olsen og Peder Voetmann Christiansen.
- 33/80 "KONSTITUERING AF FAG INDEN FOR TEKNISK - NATURVIDENSKABELIGE UDDANNELSER. I-II". Af: Arne Jakobsen.
- 34/80 "ENVIRONMENTAL IMPACT OF WIND ENERGY UTILIZATION". ENERGY SERIES NO. I. Af: Bent Sørensen. Nr. 34 er udgået.

- 35/80 "HISTORISKE STUDIER I DEN NYERE ATOMFYSIKS UDVIKLING".
Af: Helge Kragh.
- 36/80 "HVAD ER MENINGEN MED MATEMATIKUNDERVISNINGEN?".
Fire artikler.
Af: Mogens Niss.
- 37/80 "RENEWABLE ENERGY AND ENERGY STORAGE".
ENERGY SERIES NO. 2.
Af: Bent Sørensen.
-
- 38/81 "TIL EN HISTORIETEORI OM NATURERKENDELSE, TEKNOLOGI OG SAMFUND".
Projektrapport af: Erik Gade, Hans Hedal, Henrik Lau og Finn Physant.
Vejledere: Stig Andur Pedersen, Helge Kragh og Ib Thiersen.
Nr. 38 er p.t. udgået.
- 39/81 "TIL KRITIKKEN AF VÆKSTØKONOMIEN".
Af: Jens Højgaard Jensen.
- 40/81 "TELEKOMMUNIKATION I DANMARK - oplæg til en teknologivurdering".
Projektrapport af: Arne Jørgensen, Bruno Petersen og Jan Vedde.
Vejleder: Per Nørregaard.
- 41/81 "PLANNING AND POLICY CONSIDERATIONS RELATED TO THE INTRODUCTION OF RENEWABLE ENERGY SOURCES INTO ENERGY SUPPLY SYSTEMS".
ENERGY SERIES NO. 3.
Af: Bent Sørensen.
- 42/81 "VIDENSAB TEORI SAMFUND - En introduktion til materialistiske videnskabsopfattelser".
Af: Helge Kragh og Stig Andur Pedersen.
- 43/81 1. "COMPARATIVE RISK ASSESSMENT OF TOTAL ENERGY SYSTEMS".
2. "ADVANTAGES AND DISADVANTAGES OF DECENTRALIZATION".
ENERGY SERIES NO. 4.
Af: Bent Sørensen.
- 44/81 "HISTORISKE UNDERSØGELSER AF DE EKSPERIMENTELLE FORUDSÆNINGER FOR RUTHERFORDS ATOMMODEL".
Projektrapport af: Niels Thor Nielsen.
Vejleder: Bent C. Jørgensen.
-
- 45/82 Er aldrig udkommet.
- 46/82 "EKSEMPLARISK UNDERVISNING OG FYSISK ERKENDELSE-1+11 ILLUSTRERET VED TO EKSEMPLER".
Projektrapport af: Torben O. Olsen, Lasse Rasmussen og Niels Dreyer Sørensen.
Vejleder: Bent C. Jørgensen.
- 47/82 "BARSEBÄCK OG DET VÆRST OFFICIELT-TÆNKELIGE UHELD".
ENERGY SERIES NO. 5.
Af: Bent Sørensen.
- 48/82 "EN UNDERSØGELSE AF MATEMATIKUNDERVISNINGEN PÅ ADGANGSKURSUS TIL KØBENHAVNS TEKNIKUM".
Projektrapport af: Lis Eilertzen, Jørgen Karrebæk, Troels Lange, Preben Nørregaard, Lissi Pedersen, Laust Rishøj, Lill Røn og Isac Showiki.
Vejleder: Mogens Niss.
- 49/82 "ANALYSE AF MULTISPEKTRALE SATELLITBILLEDER".
Projektrapport af: Preben Nørregaard.
Vejledere: Jørgen Larsen og Rasmus Ole Rasmussen.
- 50/82 "HERSLEV - MULIGHEDER FOR VEDVARENDE ENERGI I EN LANDSBY".
ENERGY SERIES NO. 6.
Rapport af: Bent Christensen, Bent Hove Jensen, Dennis B. Møller, Bjarne Laursen, Bjarne Lillethorup og Jacob Mørch Pedersen.
Vejleder: Bent Sørensen.
- 51/82 "HVAD KAN DER GØRES FOR AT AFHJÆLPE PIGERS BLOKERING OVERFOR MATEMATIK ?"
Projektrapport af: Lis Eilertzen, Lissi Pedersen, Lill Røn og Susanne Stender.
- 52/82 "DESUSPENSION OF SPLITTING ELLIPTIC SYMBOLS".
Af: Bernhelm Booss og Krzysztof Wojciechowski.
- 53/82 "THE CONSTITUTION OF SUBJECTS IN ENGINEERING EDUCATION".
Af: Arne Jacobsen og Stig Andur Pedersen.
- 54/82 "FUTURES RESEARCH" - A Philosophical Analysis of Its Subject-Matter and Methods.
Af: Stig Andur Pedersen og Johannes Witt-Hansen.
- 55/82 "MATEMATISKE MODELLER" - Litteratur på Roskilde Universitetsbibliotek.
En biografi.
Af: Else Høyrup.
Vedr. tekst nr. 55/82 se også tekst nr. 62/83.
- 56/82 "EN - TO - MANGE" -
En undersøgelse af matematisk økologi.
Projektrapport af: Troels Lange.
Vejleder: Anders Madsen.
-
- 57/83 "ASPECT EKSPERIMENTET"-
Skjulte variable i kvantemekanikken?
Projektrapport af: Tom Juul Andersen.
Vejleder: Peder Voetmann Christiansen.
Nr. 57 er udgået.
- 58/83 "MATEMATISKE VANDRINGER" - Modelbetragtninger over spredning af dyr mellem småbiotoper i agerlandet.
Projektrapport af: Per Hammershøj Jensen og Lene Vagn Rasmussen.
Vejleder: Jørgen Larsen.
- 59/83 "THE METHODOLOGY OF ENERGY PLANNING".
ENERGY SERIES NO. 7.
Af: Bent Sørensen.
- 60/83 "MATEMATISK MODEKSPERTISE"- et eksempel.
Projektrapport af: Erik O. Gade, Jørgen Karrebæk og Preben Nørregaard.
Vejleder: Anders Madsen.
- 61/83 "FYSIKS IDEOLOGISKE FUNKTION, SOM ET EKSEMPEL PÅ EN NATURVIDENSKAB - HISTORISK SET".
Projektrapport af: Annette Post Nielsen.
Vejledere: Jens Høyrup, Jens Højgaard Jensen og Jørgen Vogelius.
- 62/83 "MATEMATISKE MODELLER" - Litteratur på Roskilde Universitetsbibliotek.
En biografi 2. rev. udgave.
Af: Else Høyrup.
- 63/83 "CREATING ENERGY FUTURES: A SHORT GUIDE TO ENERGY PLANNING".
ENERGY SERIES No. 8.
Af: David Crossley og Bent Sørensen.
- 64/83 "VON MATEMATIK UND KRIEG".
Af: Bernhelm Booss og Jens Høyrup.
- 65/83 "ANVENDT MATEMATIK - TEORI ELLER PRAKSIS".
Projektrapport af: Per Hedegård Andersen, Kirsten Habekost, Carsten Holst-Jensen, Annelise von Moos, Else Marie Pedersen og Erling Møller Pedersen.
Vejledere: Bernhelm Booss og Klaus Grünbaum.
- 66/83 "MATEMATISKE MODELLER FOR PERIODISK SELEKTION I ESCHERICHIA COLI".
Projektrapport af: Hanne Lisbet Andersen, Ole Richard Jensen og Klavs Frisdahl.
Vejledere: Jørgen Larsen og Anders Hede Madsen.
- 67/83 "ELEPZOIDE METODEN - EN NY METODE TIL LINEÆR PROGRAMMERING?".
Projektrapport af: Lone Billmann og Lars Boye.
Vejleder: Mogens Brun Heefelt.
- 68/83 "STOKASTISKE MODELLER I POPULATIONSGENETIK" - til kritikken af teoriladede modeller.
Projektrapport af: Lise Odgård Gade, Susanne Hansen, Michael Hviid og Frank Mølgård Olsen.
Vejleder: Jørgen Larsen.

- 69/83 "ELEVFORUDSÆTNINGER I FYSIK"
- en test i l.g med kommentarer.
Af: Albert C. Paulsen.
- 70/83 "INDLÆRINGS - OG FORMIDLINGSPROBLEMER I MATEMATIK PÅ VOKSENUNDERVISNINGSNIVEAU".
Projekt rapport af: Hanne Lisbet Andersen, Torben J. Andreasen, Svend Åge Houmann, Helle Glerup Jensen, Keld Fl. Nielsen, Lene Vagn Rasmussen.
Vejleder: Klaus Grünbaum og Anders Hede Madsen.
- 71/83 "PIGER OG FYSIK"
- et problem og en udfordring for skolen?
Af: Karin Beyer, Sussanne Blegaa, Birthe Olsen, Jette Reich og Mette Vedelsby.
- 72/83 "VERDEN IFØLGE PEIRCE" - to metafysiske essays, om og af C.S Peirce.
Af: Peder Voetmann Christiansen.
- 73/83 "'EN ENERGIANALYSE AF LANDBRUG"
- økologisk contra traditionelt.
ENERGY SERIES NO. 9
Specialeopgave i fysik af: Bent Hove Jensen.
Vejleder: Bent Sørensen.
-
- 74/84 "MINIATURISERING AF MIKROELEKTRONIK" - om videnskabeliggjort teknologi og nytten af at lære fysik.
Projekt rapport af: Bodil Harder og Linda Szkotak Jensen.
Vejledere: Jens Højgaard Jensen og Bent C. Jørgensen.
- 75/84 "MATEMATIKUNDERVISNINGEN I FREMTIDENS GYMNASIUM"
- Case: Lineær programmering.
Projekt rapport af: Morten Blomhøj, Klavs Frisdahl og Frank Mølgaard Olsen.
Vejledere: Mogens Brun Heefelt og Jens Bjørneboe.
- 76/84 "KERNEKRAFT I DANMARK?" - Et hørings svar indkaldt af miljøministeriet, med kritik af miljøstyrelsens rapporter af 15. marts 1984.
ENERGY SERIES No. 10
Af: Niels Boye Olsen og Bent Sørensen.
- 77/84 "POLITISKE INDEKS - FUP ELLER FAKTA?"
Opinionsundersøgelser belyst ved statistiske modeller.
Projekt rapport af: Svend Åge Houmann, Keld Nielsen og Susanne Stender.
Vejledere: Jørgen Larsen og Jens Bjørneboe.
- 78/84 "JÆVNSTRØMSLEDNINGSEVNE OG GITTERSTRUKTUR I AMORFT GERMANIUM".
Special rapport af: Hans Heddal, Frank C. Ludvigsen og Finn C. Physant.
Vejleder: Niels Boye Olsen.
- 79/84 "MATEMATIK OG ALMENDANNELSE".
Projekt rapport af: Henrik Coster, Mikael Wennerberg Johansen, Povl Kattler, Birgitte Lydholm og Morten Overgaard Nielsen.
Vejleder: Bernhelm Booss.
- 80/84 "KURSUSMATERIALE TIL MATEMATIK B".
Af: Mogens Brun Heefelt.
- 81/84 "FREKVENSafhængig LEDNINGSEVNE I AMORFT GERMANIUM".
Special rapport af: Jørgen Wind Petersen og Jan Christensen.
Vejleder: Niels Boye Olsen.
- 82/84 "MATEMATIK - OG FYSIKUNDERVISNINGEN I DET AUTOMATISERED SAMFUND".
Rapport fra et seminar afholdt i Hvidovre 25-27 april 1983.
Red.: Jens Højgaard Jensen, Bent C. Jørgensen og Mogens Niss.
- 83/84 "ON THE QUANTIFICATION OF SECURITY":
PEACE RESEARCH SERIES NO. 1
Af: Bent Sørensen
nr. 83 er p.t. udgået
- 84/84 "NOGLE ARTIKLER OM MATEMATIK, FYSIK OG ALMENDANNELSE".
Af: Jens Højgaard Jensen, Mogens Niss m. fl.
- 85/84 "CENTRIFUGALREGULATORER OG MATEMATIK".
Special rapport af: Per Hødegård Andersen, Carsten Holst-Jensen, Else Marie Pedersen og Erling Møller Pedersen.
Vejleder: Stig Andur Pedersen.
- 86/84 "SECURITY IMPLICATIONS OF ALTERNATIVE DEFENSE OPTIONS FOR WESTERN EUROPE".
PEACE RESEARCH SERIES NO. 2
Af: Bent Sørensen.
- 87/84 "A SIMPLE MODEL OF AC HOPPING CONDUCTIVITY IN DISORDERED SOLIDS".
Af: Jeppe C. Dyre.
- 88/84 "RISE, FALL AND RESURRECTION OF INFINITESIMALS".
Af: Detlef Laugwitz.
- 89/84 "FJERNVARMEOPTIMERING".
Af: Bjarne Lillethorup og Jacob Mørch Pedersen.
-
- 90/84 "ENERGI I L.G - EN TEORI FOR TILRETTELÆGGELSE".
Af: Albert Chr. Paulsen.
-
- 91/85 "KVANTETEORI FOR GYMNASIET".
1. Lærervejledning
Projekt rapport af: Biger Lundgren, Henning Sten Hansen og John Johansson.
Vejleder: Torsten Meyer.
- 92/85 "KVANTETEORI FOR GYMNASIET".
2. Materiale
Projekt rapport af: Biger Lundgren, Henning Sten Hansen og John Johansson.
Vejleder: Torsten Meyer.
- 93/85 "THE SEMIOTICS OF QUANTUM - NON - LOCALITY".
Af: Peder Voetmann Christiansen.
- 94/85 "TREENIGHEDEN BOURBAKI - generalen, matematikeren og ånden".
Projekt rapport af: Morten Blomhøj, Klavs Frisdahl og Frank M. Olsen.
Vejleder: Mogens Niss.
- 95/85 "AN ALTERNATIV DEFENSE PLAN FOR WESTERN EUROPE".
PEACE RESEARCH SERIES NO. 3
Af: Bent Sørensen
- 96/85 "ASPEKTER VED KRAFTVARMEFORSYNING".
Af: Bjarne Lillethorup.
Vejleder: Bent Sørensen.
- 97/85 "ON THE PHYSICS OF A.C. HOPPING CONDUCTIVITY".
Af: Jeppe C. Dyre.
- 98/85 "VALGMULIGHEDER I INFORMATIONSAALDEREN".
Af: Bent Sørensen.
- 99/85 "Der er langt fra Q til R".
Projekt rapport af: Niels Jørgensen og Mikael Klintorp.
Vejleder: Stig Andur Pedersen.
- 100/85 "TALSISTEMETS OPBYGNING".
Af: Mogens Niss.
- 101/85 "EXTENDED MOMENTUM THEORY FOR WINDMILLS IN PERTURBATIVE FORM".
Af: Ganesh Sengupta.
- 102/85 OPSTILLING OG ANALYSE AF MATEMATISKE MODELLER, BELYST VED MODELLER OVER KØERS FODEROPTAGELSE OG - OMSÆTNING".
Projekt rapport af: Lis Eilertzen, Kirsten Habekost, Lill Røn og Susanne Stender.
Vejleder: Klaus Grünbaum.

- 103/85 "ØDSLE KOLDKRIGERE OG VIDENSKABENS LYSE IDEER".
 Projekt rapport af: Niels Ole Dam og Kurt Jensen.
 Vejleder: Bent Sørensen.
- 104/85 "ANALOGREGNEMASKINEN OG LORENZLIGNINGER".
 Af: Jens Jøger.
- 105/85 "THE FREQUENCY DEPENDENCE OF THE SPECIFIC HEAT OF THE GLASS REANITION".
 Af: Tage Christensen.
 "A SIMPLE MODEL AF AC HOPPING CONDUCTIVITY".
 Af: Jeppe C. Dyre.
 Contributions to the Third International Conference on the Structure of Non - Crystalline Materials held in Grenoble July 1985.
- 106/85 "QUANTUM THEORY OF EXTENDED PARTICLES".
 Af: Bent Sørensen.
- 107/85 "EN MYG GØR INGEN EPIDEMI".
 - floedblindhed som eksempel på matematisk modelle-
 ring af et epidemiologisk problem.
 Projekt rapport af: Per Hedegård Andersen, Lars Boye,
 Carsten Holst Jensen, Else Marie Pedersen og Erling
 Møller Pedersen.
 Vejleder: Jesper Larsen.
- 108/85 "APPLICATIONS AND MODELLING IN THE MATHEMATICS CUR-
 RICULUM" - state and trends -
 Af: Mogens Niss.
- 109/85 "COX I STUDIETIDEN" - Cox's regressionsmodel anvendt på
 studenteroplysninger fra RUC.
 Projekt rapport af: Mikael Wennerberg Johansen, Poul Kat-
 ler og Torben J. Andreasen.
 Vejleder: Jørgen Larsen.
- 110/85 "PLANNING FOR SECURITY".
 Af: Bent Sørensen
- 111/85 "JORDEN RUNDT PÅ FLADE KORT".
 Projekt rapport af: Birgit Andresen, Beatriz Quinones
 og Jimmy Staal.
 Vejleder: Mogens Niss.
- 112/85 "VIDENSKABELIGGØRELSE AF DANSK TEKNOLOGISK INNOVATION
 FREM TIL 1950 - BELYST VED EKSEMPLER".
 Projekt rapport af: Erik Odgaard Gade, Hans Hedal,
 Frank C. Ludvigsen, Annette Post Nielsen og Finn
 Physant.
 Vejleder: Claus Bryld og Bent C. Jørgensen.
- 113/85 "DESUSPENSION OF SPLITTING ELLIPTIC SYMBOLS 11".
 Af: Bernhelm Booss og Krzysztof Wojciechowski.
- 114/85 "ANVENDELSE AF GRAFISKE METODER TIL ANALYSE
 AF KONFIGENSTABELLER".
 Projekt rapport af: Lone Billmann, Ole R. Jensen
 og Arne-Lise von Moos.
 Vejleder: Jørgen Larsen.
- 115/85 "MATEMATIKKENS UDVIKLING OP TIL RENESSANCEN".
 Af: Mogens Niss.
- 116/85 "A PHENOMENOLOGICAL MODEL FOR THE MEYER-
 NIELDEL RULE".
 Af: Jeppe C. Dyre.
- 117/85 "KRAFT & FJERNVARMEOPTIMERING"
 Af: Jacob Mørch Pedersen.
 Vejleder: Bent Sørensen
- 118/85 "TILFÆLDIGHEDEN OG NØDVENDIGHEDEN IFØLGE
 PEIRCE OG FYSIKKEN".
 Af: Peder Voetmann Christiansen
- 120/86 "ET ANTAL STATISTISKE STANDARDMODELLER".
 Af: Jørgen Larsen
- 121/86 "SIMULATION I KONTINUERT TID".
 Af: Peder Voetmann Christiansen.
- 122/86 "ON THE MECHANISM OF GLASS IONIC CONDUCTIVITY".
 Af: Jeppe C. Dyre.
- 123/86 "GYMNASIEFYSIKKEN OG DEN STORE VERDEN".
 Fysiklærerforeningen, IMFUFA, RUC.
- 124/86 "OPGAVESAMLING I MATEMATIK".
 Samtlige opgaver stillet i tiden 1974-jan. 1986.
- 125/86 "UVBY, 8 - systemet - en effektiv fotometrisk spektral-
 klassifikation af B-, A- og F-stjerner".
 Projekt rapport af: Birger Lundgren.
- 126/86 "OM UDVIKLINGEN AF DEN SPECIELLE RELATIVITETSTEORI".
 Projekt rapport af: Lise Odgaard & Linda Szkotak Jensen
 Vejledere: Karin Beyer & Stig Andur Pedersen.
- 127/86 "GALOIS' BIDRAG TIL UDVIKLINGEN AF DEN ABSTRAKTE
 ALGEBRA".
 Projekt rapport af: Pernille Sand, Heine Larsen &
 Lars Frandsen.
 Vejleder: Mogens Niss.
- 128/86 "SMÅKRYB" - om ikke-standard analyse.
 Projekt rapport af: Niels Jørgensen & Mikael Klintorp.
 Vejleder: Jeppe Dyre.
- 129/86 "PHYSICS IN SOCIETY"
 Lecture Notes 1983 (1986)
 Af: Bent Sørensen
- 130/86 "Studies in Wind Power"
 Af: Bent Sørensen
- 131/86 "FYSIK OG SAMFUND" - Et integreret fysik/historie-
 projekt om naturanskuelsens historiske udvikling
 og dens samfundsmæssige betingethed.
 Projekt rapport af: Jakob Heckscher, Søren Brønd,
 Andy Wierød.
 Vejledere: Jens Høyrup, Jørgen Vogelius,
 Jens Højgaard Jensen.
- 132/86 "FYSIK OG DANNEELSE"
 Projekt rapport af: Søren Brønd, Andy Wierød.
 Vejledere: Karin Beyer, Jørgen Vogelius.
- 133/86 "CHERNOBYL ACCIDENT: ASSESSING THE DATA.
 ENERGY SERIES NO. 15.
 AF: Bent Sørensen.
-
- 134/87 "THE D.C. AND THE A.C. ELECTRICAL TRANSPORT IN AsSeTe SYSTEM"
 Authors: M.B.El-Den, N.B.Olsen, Ib Høst Pedersen,
 Petr Visčár
- 135/87 "INTUITIONISTISK MATEMATIKS METODER OG ERKENDELSES-
 TEORETISKE FORUDSÆTNINGER"
 MATEMATIKSPECIALE: Claus Larsen
 Vejledere: Anton Jensen og Stig Andur Pedersen
- 136/87 "Mystisk og naturlig filosofi: En skitse af kristendommens
 første og andet møde med græsk filosofi"
 Projekt rapport af Frank Colding Ludvigsen
 Vejledere: Historie: Ib Thiersen
 Fysik: Jens Højgaard Jensen
- 137/87 "HOPMODELLER FOR ELEKTRISK LEDNING I UORDNEDE
 FASTE STOFFER" - Resume af licentiatafhandling
 Af: Jeppe Dyre
 Vejledere: Niels Boye Olsen og
 Peder Voetmann Christiansen.
- 119/86 "DET ER GANSKE VIST - - EUKLIDS FEMTE POSTULAT
 KUNNE NOK SKABE RØRE I ANDEDAMMEN".
 Af: Iben Maj Christiansen
 Vejleder: Mogens Niss.

138/87 "JOSEPHSON EFFECT AND CIRCLE MAP."
Paper presented at The International
Workshop on Teaching Nonlinear Phenomena
at Universities and Schools, "Chaos in
Education". Balaton, Hungary, 26 April-2 May 1987.

By: Peder Voetmann Christiansen

139/87 "Machbarkeit nichtbeherrschbarer Technik
durch Fortschritte in der Erkennbarkeit
der Natur"

Af: Bernhelm Booss-Bavnbek
Martin Bohle-Carbonell

140/87 "ON THE TOPOLOGY OF SPACES OF HOLOMORPHIC MAPS"

By: Jens Gravesen

141/87 "RADIOMETERS UDVIKLING AF BLODGASAPPARATUR -
ET TEKNOLOGIHISTORISK PROJEKT"

Projektrapport af Finn C. Physant
Vejleder: Ib Thiersen

142/87 "The Calderón Projektor for Operators With
Splitting Elliptic Symbols"

by: Bernhelm Booss-Bavnbek og
Krzysztof P. Wojciechowski

143/87 "Kursusmateriale til Matematik på NAT-BAS"

af: Mogens Brun Heefelt

TEKST NR 307

1995

Habit Formation and the Thirdness of Signs

Presented at the semiotic symposium

*The Emergence of Codes and Intentions
as a Basis of Sign Processes*

Hollufgaard, Odense, october 26-29, 1995

by

Peder Voetmann Christiansen

TEKSTER fra

IMFUFA

ROSKILDE UNIVERSITETSCENTER
INSTITUT FOR STUDIET AF MATEMATIK OG FYSIK SAMT DERES
FUNKTIONER I UNDERVISNING, FORSKNING OG ANVENDELSER

IMFUFA, Roskilde Universitetscenter, Postbox 260, DK 4000 Roskilde

Habit Formation and the Thirdness of Signs

Presented at the interdisciplinary semiotic symposium

The Emergence of Codes and Intentions as a Basis of Sign Processes

Hollufgaard, Odense, october 26-29, 1995

by Peder Voetmann Christiansen

IMFUFA tekst nr. 307/95

17 pages

ISSN 0106-6242

Abstract

The Doctrine of Signs, C. S. Peirce's *Semeiotic*, is closely connected with his evolutionary metaphysics. According to Peirce, generalization of individual events occurs in Nature and may be described as *habit formation*. In his phenomenology Peirce operates with three abstract categories or modes of being, namely *Firstness, the potential, Secondness, the actual, and Thirdness, the general*.

Whereas many biologists today regard *life* as an emergent property of sufficiently complicated aggregations of matter, closely connected with the codes and self-replicating properties of DNA, Peirce would maintain that *living feeling is a First*. The mere possibility that specific chemical reactions become general as life processes is in itself a sort of life, so it would be misleading to use the word *emergence* in connection with *life* in this general sense, unless one regards the whole universe as a living entity emerging at The Big Bang.

The actualization of specific possibilities, such as the spontaneous formation of amino acids in a prebiotic soup, is then a transition from firstness to secondness and can hardly be called an emergence either, because there is no generality to it. The generalization of biochemical processes, the transition from secondness to thirdness, is a genuine emergence, connected with the occurrence of catalysts or enzymes that code for general processes, and these are then precursors for the formation of self-replicating molecules, like DNA. The spontaneous formation of order in physical systems is illustrated with a model of *feedback* and the *mean field theory* of second order phase transitions.

Peirce's definition of a sign also involves feedback or *self reference*. His three phenomenological categories enter the triadic sign relation as 1. *Repre-sentamen*, or sign-vehicle, 2. *Object* of reference, and 3. *Interpretant*, or meaning of the sign. The meaning of the sign is the activation of a habit, and as such not presupposing human consciousness.

The *entropy* concept in physics and information theory is a measure of *potential*, specific information, so it refers to Firstness and Secondness, but not to Thirdness, and it is, therefore, unsuitable as a foundation for a theory of meaning.

1. The concept of emergence and the Peircean categories

When we try to trace the evolution of the universe forwards from the beginning we seem to encounter an indefinite number of *emergent* steps. Skipping over the formation of various elementary particles and the lightest atomic nuclei we reach a state where there is still no structure on the macroscopic scale. The whole universe is in a plasma-state of internal equilibrium between matter and radiation, but it is expanding, and its temperature is dropping. About 700.000 years after the Big Bang the plasma has become cooled to a point just below the ionization energy of hydrogen. The stable hydrogen atoms that are subsequently formed are electrically neutral and do not, therefore, interact nearly as strongly with the electromagnetic radiation as their constituent charged particles (electron and proton). The ability of the radiation to keep particles of matter dispersed in the plasma vanishes, and the particles begin to clump together under the influence of their own attractive force of gravitation. In the uniform plasma state gravitation pulls equally in all direction, but if a larger concentration of matter occurs by chance in a certain region there will be a net gravitation force attracting nearby particles towards the center of the collection, and the lump grows and becomes even more attractive. The universe has reached the point of *emergence of galaxies*, a very crucial point in prebiotic evolution, as also mentioned by Jesper Hoffmeyer.

This transition also would have been *felt* by particles as the emergence of *gravitation*, because before the occurrence of lumps of matter all gravity canceled out to zero, but suddenly there was an actual force pulling the particles towards the center of a nearby lump. However, gravitation was there all along, because otherwise no lumps could be formed. It had just been slumbering before in a state of *potentiality*, and now it became *actualized*. As the seeds of matter aggregation grew and stabilized themselves as galactic collections of dust and stars, gravitation became *generalized* to act as the

dominant force of the large scale universe. The process of generalization can also be described as *habit formation*: The accidental initial occurrence of a growing seed of matter concentration tends to redistribute all matter of the universe so that similar occurrences become less accidental and more predictable in the future.

Instead of using the word *emergence* as a magic spell, suggesting that suddenly there is something which did not have the slightest existence before, we have here a description of the formation of galaxies as a *continuous* process of growth and self-organization. The dualistic notion of existence versus non-existence is thus replaced with a notion of *three modes of being*, the three phenomenological categories of C. S. Peirce: ¹

1. Firstness = the potential.
2. Secondness = the actual.
3. Thirdness = the general.

In Peirce's philosophy these categories are very broad concepts with applications in metaphysics, cosmology, psychology, and general semiotic. By applying them in connection with a basic concept of continuity (synechism) we have a discrete, qualitative skeleton of "differences that make a difference" structuring the idea of continuous growth and making it compatible with the emergence of qualitative new features in evolution.

The formula for emergence climbing up through the Peircean categories may be stated as follows:

In the beginning there is a chaotic state of Firstness, where virtual seeds of order may arise for a moment and dissolve immediately. However, a process of continuous change of boundary conditions may lead to a state, where an accidentally formed seed may be stable. This actualized seed marks the transition to Secondness, where the real existence of structure still has no generality and no significance. If the seed has the ability to catalyze its own growth under the changed conditions, it will initiate a habitual forming of similar ordering in its surroundings, and thus the specific type of ordering acquires significance and a state of Thirdness has been obtained.

The formula above is an almost literal rendering of the famous Peirce quotation from "The Architecture of Theories" (1891): ²

"- in the beginning - infinitely remote - there was a chaos of unpersonalized feeling, which being without connection and regularity would properly be without existence. This feeling, sporting here and there in pure arbitrariness, would have started the germ of a generalizing tendency. Its other sportings would be evanescent, but this would have a growing virtue. Thus the tendency to habit would be started; and from this, with the other principles of evolution, all the regularities of the universe would be evolved."

The various disciplines of Physics emphasize the Peircean categories in different ways. In *Classical Mechanics* only Secondness occurs: There is no spontaneity (Firstness) and no irreversible tendencies to seek equilibrium in various types of attractors (Thirdness), only specific states leading to specific trajectories through the state space. In *Thermodynamics* both other categories enter the scene: Thirdness by the irreversible tendency of the systems to end in an equilibrium state, determined by the boundary conditions, where all features of the initial state have been wiped out by internal friction. Firstness is reflected in thermodynamics by the spontaneous random fluctuations around the mean behavior, conditioned by the temperature and the frictional forces. The Firstness category is the most difficult to grasp, because when we try to exemplify it by specific examples and general types we are already introducing Secondness and Thirdness. However, Firstness has made a remarkable entry into *Quantum Mechanics* through the concept of the wave function as describing the state of a system. The properties of a system that are inherent in its wave function are only potential, not actual. An electron has no definite position or momentum; these properties only become actualized in the context of specific types of apparatus and acts of measurement.

In the discussion of the evolution of life and its general types and functions it may be argued on Peircean grounds, that *Life* itself is a potentiality and thus belongs to the category of Firstness. Like gravitation in

the example of the nucleation of galaxies it must have been there before its specific and general manifestations, like pieces of RNA and the genetic code. These manifestations did not suddenly occur but must have been preceded by a long process of experimentation and virtual attempts. The emergence of the whole multitude of life-forms and behavioral patterns may thus be regarded as a long process of awakening from a dreaming sort of life. Life, as a Firstness, did not emerge but existed all along with the physical universe from the very beginning. Its general features in the present state, like the *code duality* (J. Hoffmeyer) must have emerged from Firstness through Secondness to Thirdness.

2. Mean field theory of spontaneous ordering

A simple physical model for the emergence of order is found in the thermodynamic description of *phase transitions*. In many cases one of the two phases involved possesses a type of order that is absent in the other phase. For example, the liquid phase exhibits a *surface*, the gaseous phase has none. The ferromagnet has a *spontaneous magnetization* below the Curie-temperature, but above this temperature it is paramagnetic with no magnetization in the absence of an external magnetic field. The superconductor has a *condensate* consisting of paired electrons which are not found in the normal metal. The ordered phase of β -brass (50% Cu and 50% Zn) has a *long range order*, the Cu-atoms tend to occupy the positions on one of two interpenetrating crystal lattices and the Zn-atoms tend to occupy the other lattice, and this long range order vanishes in the disordered phase (but still, a short range order prevails). In all these cases it is possible to describe the type of ordering by introducing an *order parameter*, and the transition from the disordered to the ordered phase in the absence of an external ordering field is then a so called *second order phase transition*, where the order parameter spontaneously forms as a seed at a certain critical temperature

and grows in a continuous way below this temperature. The spontaneous formation of order is associated with a *breaking of the symmetry* of the disordered phase, e.g. the magnetization of a ferromagnetic has a specific direction in space whereas the paramagnetic phase is isotropic and has no preferred direction. The choice of a specific direction is totally random: there is no way it can be predicted from the properties of the disordered phase.

In cases where the order is induced by the presence of an external ordering field the transition to the ordered phase is discontinuous and not spontaneous. In this case we have a *first order phase transition*. The ordering field may be as simple as an external pressure (in the gas-liquid transition) or a magnetic field (in the paramagnet-ferromagnet transition), but in other cases, like superconductors and β -brass the ordering field is of a more subtle nature and may be difficult to provide from external sources in the laboratory.

In the so called *mean field theory* of phase transitions we imagine that the ordering effect of an external field is assisted by an *internal field* which is created by the induced or spontaneously formed order parameter. The internal field must be locally determined by the locally existing order, and it can therefore be expected to fluctuate wildly from place to place in the disordered phase, but the mean field theory disregards all these fluctuations and consider only the action of an averaged internal field. In this way we get a simple and general theory of all sorts of disorder-order transitions. The mean field approximation works very well in the case of superconductivity and gravitational nucleation (galaxy formation), but in other cases, such as ferromagnets, it gives only a qualitative understanding. However, a qualitative description is all we need in this context, so we shall specialize to the case of the paramagnet-ferromagnet transition.

In the disordered phase (paramagnet) we can use a linear response model for the ordering effect of the fields. A magnetic field H induces a magnetization M , given by

$$M = \chi \cdot H \quad (1)$$

where χ is the paramagnetic susceptibility. According to statistical mechanics this can be expressed as

$$\chi = \frac{C}{T} \quad (2)$$

where C is the Curie-constant and T is the absolute temperature. Considering now, that the induced magnetization creates an internal ordering field H_i by some linear relation

$$H_i = A \cdot M \quad (3)$$

and that the effective field in (1) is the sum of the external field H_e and the internal mean field, H_i , we have a model of linear positive feedback:

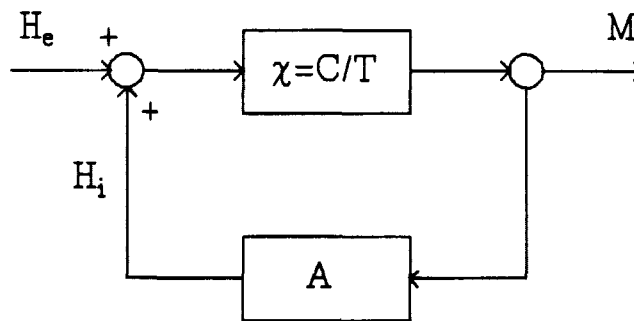

Figure 1 Linear feedback model for the disordered (paramagnetic) phase.

The feedback equation

$$M = \chi \cdot (H_e + H_i) = \frac{C}{T} \cdot (H_e + A \cdot M) \quad (4)$$

can now be solved for M , and we obtain:

$$M = \frac{C}{T - T_c} \cdot H_e, \text{ where } T_c = C \cdot A \quad (5)$$

It is seen that the linear feedback model can only be valid for temperatures above *the critical temperature* (the Curie temperature) T_c . At T_c we may have a finite order parameter M for a vanishing external ordering field. The critical temperature, therefore, marks the *onset of instability of the disordered phase*.

What happens below the critical temperature the linear feedback model can say nothing about. The actual value of the spontaneously formed and stabilized order parameter is determined by non-linear characteristics of the system. The situation is well known, e.g in an auditorium where a microphone and an amplifier transmits the speaker's words to a loudspeaker. When the amplification is too high (a large value of χ) or the loudspeaker is too close to the microphone (a large value of A) a screaming noise emerges whose loudness and main frequencies are determined by the non-linearities of the amplifier.

The linear behavior of the system in the disordered phase can be described with a thermodynamic potential that is quadratic in the order parameter:

$$G(M; T, H_e) = \alpha(T) \cdot M^2 - H_e \cdot M \text{ for } T > T_c \quad (6)$$

and the equilibrium value of the order parameter is then the unique value that minimizes the potential, i.e.

$$M = \frac{H_e}{2\alpha} \quad (7)$$

Comparing this with eq. (5) we find that α is given by:

$$\alpha = \frac{T - T_c}{2C} \quad (8)$$

Following the russian physicist L. D. Landau (1950)³ we now introduce the non-linearity in the simplest possible way by adding a fourth

order term to the thermodynamic potential (6):

$$G (M ; T , H_e) = \frac{T - T_c}{2C} \cdot M^2 + \beta \cdot M^4 - H_e \cdot M \quad (9)$$

This expression is to be regarded as a series expansion to the lowest significant order in M in the neighborhood of the critical temperature. The reason why the fourth order becomes significant near T_c is that the second order term vanishes at T_c due to the feedback mechanism. The coefficient β does not vanish and can therefore be regarded as a constant in the critical region.

Dependent on the two control parameters T and H_e the expression (9) will have either one or two minima as a function of the order parameter M . The region with two minima in the control parameter plane is bounded by the curve

$$T < T_c - 3C \beta^{1/3} H_e^{2/3} \quad (10)$$

This curve, which exhibits a *cusp* at $T = T_c$ and $H_e = 0$ is the *catastrophe set*, and the Landau mean field theory is thus an example of the cusp catastrophe of René Thom ⁴. In figure 2 the catastrophe set is seen together with three examples of the function $G(M)$, two for points A and A_1 on the catastrophe set and one for the point A_0 where the external ordering field is absent and the function has two symmetric minima:

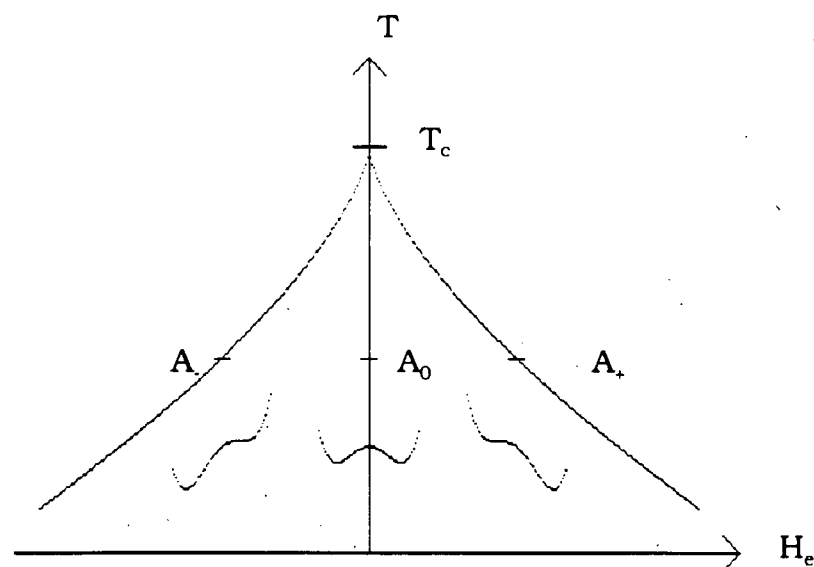

Figure 2 Catastrophe set for the Landau mean field theory of the ferromagnetic phase transition.

When there is no external ordering field and the temperature is slowly decreased from above to below the critical temperature we get a second order phase transition at the cusp point associated with a spontaneous break of symmetry, a forced choice between the two symmetric minima. The emergence of a new type of order in the universe must happen in a similar way, because the ordering field must be slumbering in a state of Firstness before the order parameter has suggested itself and has grown from its first random seed.

3. The sign relation and the law of mind

The feedback model in figure 1 describes the emergence of order as due to a sort of *self-reference*. The order parameter, whose seed arose by pure chance, refers back to and thereby enhances itself through the action of the internal ordering field. In a similar way a chemical chain of reactions may

become significant by *autocatalysis* when one of the initial reactants occurs as a reaction product later in the chain:

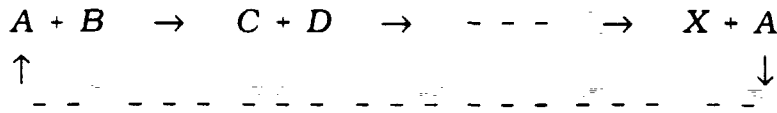

This sort of self reference on a pre-biological stage of the evolution seems to be a necessary condition for the emergence and spreading of symbolic signs, i.e. signs existing on the level of Peircean Thirdness. The internal self reference (autocatalysis) establishes a *habit* which is the meaning and inter-pretant of the sign. The habit tends to spread out to the surroundings by cross-catalysis and thus new symbolic signs become associated with the first. The sign is not dependent on a pre-existing consciousness in order to acquire meaning, but meaning is created by the internal awareness of self and others that grows from self reference and associative power (auto- and cross-catalysis). This mechanism of emergence is what Peirce calls *The Law of Mind*.

The definition of a sign, according to Peirce, ought to be free from reference to human consciousness, or language, although this may seem awkward. (In many cases he includes a human interpreter in the sign definition, but admits that this is a "sop to Cerberus"). The "purest" formulation in this sense ⁵ makes it clear, that self-reference must be inherent in the definition of the sign. Below, we analyze this definition, which for the sake of clarity is here divided into smaller sections:

1. *A Sign, or Representamen, is a First*
2. *which stands in such a genuine triadic relation to a Second, called its Object,*

3. as to be capable of determining a Third, called its *Interpretant*, to assume the same triadic relation to its Object in which it stands itself to the same object.

The three sections of the definition are seen to reflect the three phenomenological categories. The first section is self-contained: the sign as a First refers to nothing else; it is an *icon* of itself. Reference to an object is introduced as a *dyadic* relation in the second section, for although the text speaks about a *genuine* (i.e. irreducible) *triadic* relation, the third factor has not been introduced yet. The Secondness of the sign is an *index* of the object. In the third section two other dyadic relations entering the triad are mentioned: the first of these points from the object to the interpretant (mediated by the representamen), and the second points back from the interpretant to the representamen. In this part Thirdness enters as self-reference in the words "same" and "itself". The interpretant endows the sign relation with an awareness that the interpretant and the representamen are both *symbolic* signs for the same object, and this awareness does not come from any external factors, but from the internal feedback or reflexivity described in the definition. The definition is summarized diagrammatically below:

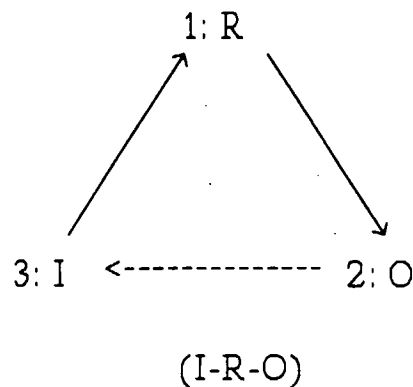

Figure 3 The sign as a triadic relation. R = Representamen, O = Object, I = Interpretant.

At the bottom of the figure is shown a linear representation of the sign relation, I-R-O with two *sign links* (-) connecting the three factors, R, O, and I. The sign links represent physical processes and are *interaction bonds*, i.e. each link contain two oppositely directed causal relations, as can be seen by comparison with the triangular causal diagram above. The linear diagram has the advantage of showing that the causal relation between O and I can only exist as mediated by R. Also, it makes it easier to depict a chain of signs, where the interpretant of the first relation becomes the representamen of the second relation, and the representamen of the first relation becomes the object of the second relation

The reflexivity of the sign relation is the feature that makes this particular way of chaining signs possible, in a way similar to the way autocatalysis is generalized to cross-catalysis. This is the idea of *unlimited semiosis*, the potential of creating new meaning that is inherent in Peirce's conception of meaning and in the Law of Mind. In continuation of the sign definition quoted above he says:

"The Third must indeed stand in such a relation, and thus must be capable of determining a Third of its own; but besides that, it must have a second triadic relation in which the Representamen, or rather the relation thereof to its Object, shall be its own (the Third's) Object, and must be capable of determining a Third to this relation. And this must equally be true of the Third's Thirds and so on endlessly; - - "

The diagram below shows how the new interpretant (J, the "Third's Third") can be chained to the first relation I-R-O, so we get J-I-R-O where the second relation J-I-R has I as the representamen and R as the object.

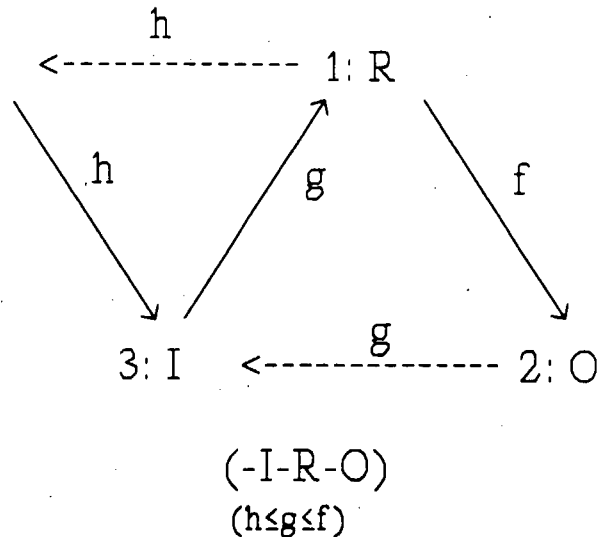

Figure 4 A more detailed diagram of the sign relation showing its potential for creating a new sign with I as the representamen and R as the object.

The causal relations in figure 4 are labelled with letters, f, g, and h which have the additional meaning of *category numbers* assessing the relations as either 1: potential, 2: actual, or 3: general. The following *selection rule* must be valid in order to ensure that the chain is unbroken:

$$h \leq g \leq f \quad (11)$$

The links can then be similarly categorized: the R-O link by f, the I-O link by g, because the connection between I and O is established by the I-R link. The g-relations (I-O and I-R) represent the *ground* of the sign relation (this is not very clearly stated in Peirce's verbal formulations, and there is no general consensus about how "the ground" ought to be defined). The ground (as defined here) and its category number g gives rise to the basic sign classification: 1: icon, 2: index, and 3: symbol. The h-relations and the J-I link is the ground of the second sign relation and categorizes the first relation as 1: rheme, 2: proposition (dicisign), or 3: argument, whereas the category f of the R-O link classifies the representamen as 1: tone (qualisign), 2: token

(sinsign), or 3: type (legisign). As the category numbers have to obey the selection rule (11) the more detailed classification based on the triplets (hgf) leads to ten classes of signs that can be arranged in a Pythagorean *tetraktys*.⁶

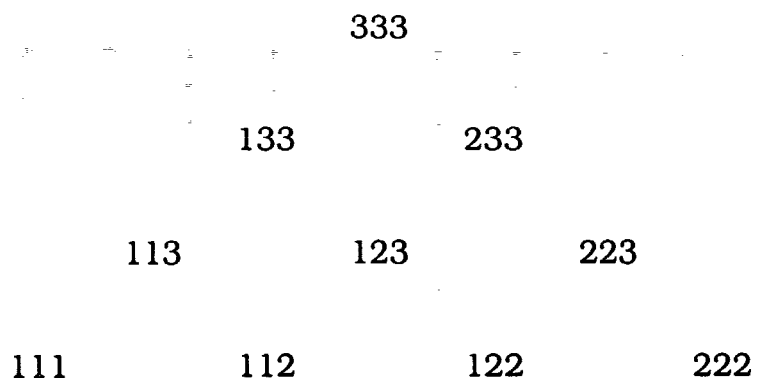

Figure 5 The ten classes of sign-triplets (hgf).

A sign classification scheme like the above represents a sort of evolutionary history of the sign, because a higher category number of a certain link must be built upon the lower categories. Thus the fully developed argument (333) must include all the nine lower classes of the tetraktys and therefore represent a *history* starting with the qualisign (111) and proceeding by gradually increasing the categories by successive actualizations (1 to 2) and generalizations (2 to 3). Generally, a chain with n links where the category numbers of the links obey the selection rule (5) (i.e. never increasing when going from the object O down the chain to the left) will correspond to the following number of classes:

$$C(n) = \frac{1}{2} \cdot (n + 1) \cdot (n + 2) \quad (12)$$

So, the classification of the ground ($n=1$) gives $C(1)=3$ classes (icon, index, symbol), the three link description gives $C(3)=10$ classes. It is then tempting to regard the sign as a ten-link history and go further in the classification to $C(10)=66$ classes, and this is in fact the number given by Peirce for the next level of classification.⁷

Returning for a moment to the initial example of matter and gravitation: We can regard a force of gravity as a sign (R) pointing to an object (O) that is a collection of mass. The interpretant (I) is then the general understanding, the recognition of a habit, that is expressed in the law of mass attraction by gravitation. However, this triadic sign relation also contains a history of evolution in three stages: First, the mass was dispersed and its gravitation only potential, but a random collection took place. Second, the lump of matter persisted long enough to be a distinct entity. Third, the gravitational force attracted matter from the surroundings until a habitual balance was obtained. These two descriptions are a synchronic and a diachronic elaboration in three links of the one link ground, gravitation as a sign. A further elaboration will lead to a synchronic classification with ten classes (the tetraktys) and a diachronic history of evolution through ten stages. If a sign is not fully developed to thirdness in all its links, its history will be accordingly truncated, i.e. from some stage its links are not understandable (habitual, general), but only (accidentally) actual or potential.

4. Entropy, information, and meaning

It has been argued in this paper that we may speak of meaningful structures as something that has to do with the formation of habits in the physical universe, i.e. Peicean Thirdness, and that this "Law of Mind" does not presuppose human consciousness. This way of speaking should not be construed as a sort of physical reductionism, but rather as an attempt to show, that even the physical description presupposes some "anthropomorphic" concepts, like "habit" and "choice" that are not derivable from physical first principles. Life, considered as a Peircean Firstness, has been there all the time, but we must try to understand how the present life-forms have emerged in a continuous way from its pre-biotic beginnings.

An alternative approach to the discussion of meaningful structures on a physical basis is the attempt to discuss "information" as something related to physical entropy, as presented by Tom Stonier at this conference. A few critical remarks to this approach may be relevant here.

"Information" may be without any meaning and still exist. "Meaning" is something general, a Thirdness, but a specific string of letters, like "sjxipesdgo" that contains information, does not necessarily contain meaning. From the viewpoint of the telecommunication engineer it is essential that the information transmitted through a telephone line is actual, but meaningless, i.e. it exists on a level of Peircean Secondness. Entropy in a physical system is not "lack of information" i.e. non-existing information, but *potential* information about the exact microscopic state of the system. In principle this information could be obtained or *actualized* whereby the microstate would be known and the entropy reduced to zero. In this case the existing information would change its mode of being from firstness to secondness, but thirdness is out of the question, because it is a *specific* information that cannot be *generalized*. So, entropy is a *potential, meaningless information*. If we try to build a theory of meaning by saying that "entropy is lack of information, so information must be negative entropy, and information has meaning", then we are in fact saying that meaning can be understood as "lack of meaningfulness".

There is nothing wrong with Shannon's "Theory of Information" when we remember that the potential meaning of the Shannon-information is outside the scope of the theory and is left to the human listener on the telephone. Also, there is nothing wrong with the information theoretical description of physical entropy as potential information about the microstate of a physical system, so it is not just a funny coincidence that Shannon's information and Gibbs' entropy are given by the same probabilistic formula. The physical information theory, as worked out by Szilard and Brillouin ⁸ in the discussion of Maxwell's demon has something important to say on the

physical limits of how much structure a system can exhibit, but it can say nothing about whether these structures are meaningful or not.

A theory of meaning must take departure in the concept of a sign, and here Peirce's semiotic philosophy, physical theories of spontaneous order formation, and René Thom's catastrophe theory are applicable, because they build on the notion of an underlying continuum from which discrete categories may emerge by continuous growth and habit formation. In this way we may be able to bridge the gap between naturalistic and humanistic studies.

References

The abbreviation CP refers to:

Collected Papers, C. S. Peirce, 1969, ed. Charles Hartshorne and Paul Weiss, The Belknap Press of Harvard University Press, Cambridge Mass., vol. 1-8.

1. J. Buchler, *Philosophical Writings of Peirce*, 1955, Dover Publications, Inc., New York.
The categories are introduced in the article *The Principles of Phenomenology*, section 2, which is from a manuscript from 1902 (CP 1.23-6).
2. *The Monist*, vol. 1, 1891. See ref. 1 or CP 6.7-34.
3. L. D. Landau and E. M. Lifshitz, *Statistical Physics*, 1959, Pergamon Press, London.
4. T. Poston and I. Stewart, *Catastrophe Theory and its Applications*, 1978, London.
5. CP 2.274, ca 1902, or ref. 1, p. 99-100.
6. CP 2.243 or ref. 1 p. 115-119.
7. Peirce's letter to Lady Welby, december 23., 1908. See: I. C. Lieb, *Charles S. Peirce's Letters to Lady Welby*, 1953, New Haven.
8. L. Brillouin, *Science and Information Theory*, 1962, Academic Press, N.Y.

Liste over tidligere udkomne tekster
tilsendes gerne. Henvendelse herom kan
ske til IMFUFA's sekretariat
tlf. 46 75 77 11 lokal 2263

-
- 217/92 "Two papers on APPLICATIONS AND MODELLING
IN THE MATHEMATICS CURRICULUM"
by: Mogens Niss
- 218/92 "A Three-Square Theorem"
by: Lars Kadison
- 219/92 "RUPNOK - stationær strømning i elastiske rør"
af: Anja Boisen, Karen Birkelund, Mette Olufsen
Vejleder: Jesper Larsen
- 220/92 "Automatisk diagnosticering i digitale kredsløb"
af: Bjørn Christensen, Ole Møller Nielsen
Vejleder: Stig Andur Pedersen
- 221/92 "A BUNDLE VALUED RADON TRANSFORM, WITH
APPLICATIONS TO INVARIANT WAVE EQUATIONS"
by: Thomas P. Branson, Gestur Olafsson and
Henrik Schlichtkrull
- 222/92 On the Representations of some Infinite Dimensional
Groups and Algebras Related to Quantum Physics
by: Johnny T. Ottesen
- 223/92 THE FUNCTIONAL DETERMINANT
by: Thomas P. Branson
- 224/92 UNIVERSAL AC CONDUCTIVITY OF NON-METALLIC SOLIDS AT
LOW TEMPERATURES
by: Jeppe C. Dyre
- 225/92 "HATMODELLEN" Impedansspektroskopi i ultrarent
en-krystallinsk silicium
af: Anja Boisen, Anders Gorm Larsen, Jesper Varmer,
Johannes K. Nielsen, Kit R. Hansen, Peter Bøggild
og Thomas Hougaard
Vejleder: Petr Viscor
- 226/92 "METHODS AND MODELS FOR ESTIMATING THE GLOBAL
CIRCULATION OF SELECTED EMISSIONS FROM ENERGY
CONVERSION"
by: Bent Sørensen

- 227/92 "Computersimulering og fysik"
af: Per M. Hansen, Steffen Holm,
Peter Maibom, Mads K. Dall Petersen,
Pernille Postgaard, Thomas B. Schröder,
Ivar P. Zeck
Vejleder: Peder Voetmann Christiansen
- 228/92 "Teknologi og historie"
Fire artikler af:
Mogens Niss, Jens Høyrup, Ib Thiersen,
Hans Hedal
- 229/92 "Masser af information uden betydning"
En diskussion af informationsteorien
i Tor Nørretranders' "Mærk Verden" og
en skitse til et alternativ baseret
på andenordens kybernetik og semiotik.
af: Søren Brier
- 230/92 "Vinklens tredeling - et klassisk
problem"
et matematisk projekt af
Karen Birkelund, Bjørn Christensen
Vejleder: Johnny Ottesen
- 231A/92 "Elektron diffusion i silicium - en
matematisk model"
af: Jesper Voetmann, Karen Birkelund,
Mette Olufsen, Ole Møller Nielsen
Vejledere: Johnny Ottesen, H.B. Hansen
- 231B/92 "Elektron diffusion i silicium - en
matematisk model" Kildetekster
af: Jesper Voetmann, Karen Birkelund,
Mette Olufsen, Ole Møller Nielsen
Vejledere: Johnny Ottesen, H.B. Hansen
- 232/92 "Undersøgelse om den simultane opdagelse
af energiens bevarelse og isærdeles om
de af Mayer, Colding, Joule og Helmholtz
udførte arbejder"
af: L. Arleth, G.I. Dybkjær, M.T. Østergård
Vejleder: Dorthe Posselt
- 233/92 "The effect of age-dependent host
mortality on the dynamics of an endemic
disease and
Instability in an SIR-model with age-
dependent susceptibility
by: Viggo Andreassen
- 234/92 "THE FUNCTIONAL DETERMINANT OF A FOUR-DIMENSIONAL
BOUNDARY VALUE PROBLEM"
by: Thomas P. Branson and Peter B. Gilkey
- 235/92 OVERFLADESTRUKTUR OG POREUDVIKLING AF KOKS
- Modul 3 fysik projekt -
af: Thomas Jessen
-

- 236a/93 INTRODUKTION TIL KVANTE HALL EFFEKTEN
af: Anja Boisen, Peter Bøggild
Vejleder: Peder Voetmann Christiansen
.Eriand Brun Hansen
- 236b/93 STRØMSSAMMENBRUD AF KVANTE HALL EFFEKTEN
af: Anja Boisen, Peter Bøggild
Vejleder: Peder Voetmann Christiansen
Eriand Brun Hansen
- 237/93 The Wedderburn principal theorem and Shukla cohomology
af: Lars Kadison
- 238/93 SEMIOTIK OG SYSTEMEGENSKABER (2)
Vektorbånd og tensorer
af: Peder Voetmann Christiansen
- 239/93 Valgsystemer - Modelbygning og analyse
Matematik 2. modul
af: Charlotte Gjerrild, Jane Hansen, Maria Hermannsson, Allan Jørgensen, Ragna Clauson-Kaas, Poul Lützen
Vejleder: Mogens Niss
- 240/93 Patologiske eksempler.
Om sære matematiske fiks betydning for den matematiske udvikling
af: Claus Dråby, Jørn Skov Hansen, Runa Ulsøe Johansen, Peter Meibom, Johannes Kristoffer Nielsen
Vejleder: Mogens Niss
- 241/93 FOTOVOLTAISK STATUSNOTAT 1
af: Bent Sørensen
- 242/93 Brovedligeholdelse - bevar mig vel
Analyse af Vejdirektoratets model for optimering af broreparationer
af: Linda Kyndlev, Kare Fundal, Kamma Tulinius, Ivar Zeck
Vejleder: Jesper Larsen
- 243/93 TANKEEKSPERIMENTER I FYSIKKEN
Et 1.modul fysikprojekt
af: Karen Birkelund, Stine Sofia Korremann
Vejleder: Dorthe Posselt
- 244/93 RADONTRANSFORMATIONEN og dens anvendelse i CT-scanning
Projektrapport
af: Trine Andreasen, Tine Guldager Christiansen, Nina Skov Hansen og Christine Iversen
Vejledere: Gestur Olafsson og Jesper Larsen
- 245a+b
/93 Time-Of-Flight målinger på krystallinske halvledere
Specialerapport
af: Linda Szkotak Jensen og Lise Odgaard Gade
Vejledere: Petr Viscor og Niels Boye Olsen
- 246/93 HVERDAGSVIDEN OG MATEMATIK - LÆREPROCESSER I SKOLEN
af: Lena Lindenskov, Statens Humanistiske Forskningsråd, RUC, IMPUFA
- 247/93 UNIVERSAL LOW TEMPERATURE AC CONDUCTIVITY OF MACROSCOPICALLY DISORDERED NON-METALS
by: Jeppe C. Dyre
- 248/93 DIRAC OPERATORS AND MANIFOLDS WITH BOUNDARY
by: B. Booss-Bavnbek, K.P.Wojciechowski
- 249/93 Perspectives on Teichmüller and the Jahresbericht Addendum to Schappacher, Scholz, et al.
by: B. Booss-Bavnbek
With comments by W.Abikoff, L.Ahlfors, J.Cerf, P.J.Davis, W.Fuchs, F.P.Gardiner, J.Jost, J.-P.Kahane, R.Lohan, L.Lorch, J.Radkau and T.Söderqvist
- 250/93 EULER OG BOLZANO - MATEMATISK ANALYSE SET I ET VIDENSKABSTEORETISK PERSPEKTIV
Projektrapport af: Anja Juul, Lone Michelsen, Tomas Højgård Jensen
Vejleder: Stig Andur Pedersen
- 251/93 Genotypic Proportions in Hybrid Zones
by: Freddy Bugge Christiansen, Viggo Andreasen and Ebbe Thue Poulsen
- 252/93 MODELLERING AF TILFÆLDIGE FÆNOMENER
Projektrapport af: Birthe Friis, Lisbeth Helmgård Kristina Charlotte Jakobsen, Marina Mosbæk Johannessen, Lotte Ludvigsen, Mette Hass Nielsen
- 253/93 Kuglepakning
Teori og model
af: Lise Arleth, Kåre Fundal, Nils Kruse
Vejleder: Mogens Niss
- 254/93 Regressionsanalyse
Materiale til et statistikkursus
af: Jørgen Larsen
- 255/93 TID & BETINGET UAFHÆNGIGHED
af: Peter Harremoës
- 256/93 Determination of the Frequency Dependent Bulk Modulus of Liquids Using a Piezoelectric Spherical Shell (Preprint)
by: T. Christensen and N.B.Olsen
- 257/93 Modellering af dispersion i piezoelektriske keramikker
af: Pernille Postgaard, Jannik Rasmussen, Christina Specht, Mikko Østergård
Vejleder: Tage Christensen
- 258/93 Supplerende kursusmateriale til "Lineære strukturer fra algebra og analyse"
af: Mogens Brun Heefelt
- 259/93 STUDIES OF AC HOPPING CONDUCTION AT LOW TEMPERATURES
by: Jeppe C. Dyre
- 260/93 PARTITIONED MANIFOLDS AND INVARIANTS IN DIMENSIONS 2, 3, AND 4
by: B. Booss-Bavnbek, K.P.Wojciechowski

- 261/93 OPGAVESAMLING
Bredde-kursus i Fysik
Eksamensopgaver fra 1976-93
- 262/93 Separability and the Jones
Polynomial
by: Lars Kadison
- 263/93 Supplerende kursusmateriale til
"Lineære strukturer fra algebra
og analyse" II
af: Mogens Brøn Heefelt
- 264/93 FOTOVOLTAISK STATUSNOTAT 2
af: Bent Sørensen
-
- 265/94 SPHERICAL FUNCTIONS ON ORDERED
SYMMETRIC SPACES
To Sigurdur Helgason on his
sixtyfifth birthday
by: Jacques Paraut, Joachim Hilgert
and Gestur Olafsson
- 266/94 Kommensurabilitets-oscillationer i
laterale supergitre
Fysikspeciale af: Anja Boisen,
Peter Bøggild, Karen Birkelund
Vejledere: Rafael Taboryski, Poul Erik
Lindelof, Peder Voetmann Christiansen
- 267/94 Kom til kort med matematik på
Eksperimentarium - Et forslag til en
opstilling
af: Charlotte Gjerrild, Jane Hansen
Vejleder: Bernhelm Booss-Bavnbek
- 268/94 Life is like a sewer ...
Et projekt om modellering af aorta via
en model for strømning i kloakrør
af: Anders Marcussen, Anne C. Nilsson,
Lone Michelsen, Per M. Hansen
Vejleder: Jesper Larsen
- 269/94 Dimensionsanalyse en introduktion
metaprojekt, fysik
af: Tine Guldager Christiansen,
Ken Andersen, Nikolaj Hermann,
Jannik Rasmussen
Vejleder: Jens Højgaard Jensen
- 270/94 THE IMAGE OF THE ENVELOPING ALGEBRA
AND IRREDUCIBILITY OF INDUCED REPRESENTATIONS OF EXPONENTIAL LIE GROUPS
by: Jacob Jacobsen
- 271/94 Matematikken i Fysikken.
Opdaget eller opfundet
NAT-BAS-projekt
vejleder: Jens Højgaard Jensen
- 272/94 Tradition og fornyelse
Det praktiske eleverbejde i gymnasiets
fysikundervisning, 1907-1988
af: Kristian Hoppe og Jeppe Guldager
Vejledning: Karin Beyer og Nils Hybel
- 273/94 Model for kort- og mellemdistanceløb
Verifikation af model
af: Lise Fabricius Christensen, Helle Pilemann,
Bettina Sørensen
Vejleder: Mette Olufsen
- 274/94 MODEL-10 - en matematisk model af intravenøse
anæstetikas farmakokinetik
3. modul matematik, forår 1994
af: Trine Andreasen, Bjørn Christensen, Christine
Green, Anja Skjoldborg Hansen, Lisbeth
Helmgård
Vejledere: Viggo Andreasen & Jesper Larsen
- 275/94 Perspectives on Teichmüller and the Jahresbericht
2nd Edition
by: Bernhelm Booss-Bavnbek
- 276/94 Dispersionsmodellering
Projektrapport 1. modul
af: Gitte Andersen, Rehannah Borup, Lisbeth Friis,
Per Gregersen, Kristina Vejro
Vejleder: Bernhelm Booss-Bavnbek
- 277/94 PROJEKTARBEJDSPÆDAGOGIK - Om tre tolkninger af
problemorienteret projektarbejde
af: Claus Flensted Behrens, Frederik Voetmann
Christiansen, Jørn Skov Hansen, Thomas
Thingstrup
Vejleder: Jens Højgaard Jensen
- 278/94 The Models Underlying the Anaesthesia
Simulator Sophus
by: Mette Olufsen(Math-Tech), Finn Nielsen
(RISØ National Laboratory), Per Føge Jensen
(Herlev University Hospital), Stig Andur
Pedersen (Roskilde University)
- 279/94 Description of a method of measuring the shear
modulus of supercooled liquids and a comparison
of their thermal and mechanical response
functions.
af: Tage Christensen
- 280/94 A Course in Projective Geometry
by Lars Kadison and Matthias T. Kromann
- 281/94 Modellering af Det Cardiovasculære System med
Neural Puls kontrol
Projektrapport udarbejdet af:
Stefan Frello, Runa Ulsøe Johansen,
Michael Poul Curt Hansen, Klaus Dahl Jensen
Vejleder: Viggo Andreasen
- 282/94 Parallele algoritmer
af: Erwin Dan Nielsen, Jan Danielsen,
Niels Bo Johansen

- 283/94 Grænser for tilfældighed
(en kaotisk talgenerator)
af: Erwin Dan Nielsen og Niels Bo Johansen
- 284/94 Det er ikke til at se det, hvis man ikke
lige ve' det!
Gymnasie matematikkens begrundelsesproblem
En specialerapport af Peter Hauge Jensen
og Linda Kyndlev
Veileder: Mogens Niss
- 285/94 Slow coevolution of a viral pathogen and
its diploid host
by: Viggo Andreassen and
Freddy B. Christiansen
- 286/94 The energy master equation: A low-temperature
approximation to Bässler's random walk model
by: Jeppe C. Dyre
- 287/94 A Statistical Mechanical Approximation for the
Calculation of Time Auto-Correlation Functions
by: Jeppe C. Dyre
- 288/95 PROGRESS IN WIND ENERGY UTILIZATION
by: Bent Sørensen
- 289/95 Universal Time-Dependence of the Mean-Square
Displacement in Extremely Rugged Energy
Landscapes with Equal Minima
by: Jeppe C. Dyre and Jacob Jacobsen
- 290/95 Modellering af uregelmæssige bølger
Et 3.modul matematik projekt
af: Anders Marcussen, Anné Charlotte Nilsson,
Lone Michelsen, Per Mørkegaard Hansen
Vejleder: Jesper Larsen
- 291/95 1st Annual Report from the project
LIFE-CYCLE ANALYSIS OF THE TOTAL DANISH
ENERGY SYSTEM
an example of using methods developed for the
OECD/IEA and the US/EU fuel cycle externality study
by: Bent Sørensen
- 292/95 Fotovoltaisk Statusnotat 3
af: Bent Sørensen
- 293/95 Geometridiskussionen - hvor blev den af?
af: Lotte Ludvigsen & Jens Frandsen
Vejledere: Anders Madsen
- 294/95 Universets udvidelse -
et metaprojekt
Af: Jesper Duelund og Birthe Friis
Vejleder: Ib Lundgaard Rasmussen
- 295/95 A Review of Mathematical Modeling of the
Controlled Cardiovascular System
By: Johnny T. Ottesen
- 296/95 RETIKULER den klassiske mekanik
af: Peder Voetmann Christiansen
- 297/95 A fluid-dynamical model of the aorta with
bifurcations
by: Mette Olufsen and Johnny Ottesen
- 298/95 Mordet på Schrödingers kat - et metaprojekt om
to fortolkninger af kvantemekanikken
af: Maria Hermannsson, Sebastian Horst,
Christina Specht
Vejledere: Jeppe Dyre og Peder Voetmann Christiansen
- 299/95 ADAM under figenbladet - et kig på en samfunds-
videnskabelig matematisk model
Et matematisk modelprojekt
af: Claus Drøby, Michael Hansen, Tomas Højgård Jensen
Vejleder: Jørgen Larsen
- 300/95 Scenarios for Greenhouse Warming Mitigation
by: Bent Sørensen
- 301/95 TOK Modellering af træers vækst under påvirkning
af ozon
af: Glenn Møller-Holst, Marina Johannessen, Birthe
Nielsen og Bettina Sørensen
Vejleder: Jesper Larsen
- 302/95 KOMPRESSORER - Analyse af en matematisk model for
aksialkompressorer
Projektrapport af: Stine Bøggild, Jakob Hilmer,
Pernille Postgaard
Vejleder: Viggo Andreassen
- 303/95 Masterlignings-modeller af Glasovergangen
Termisk-Mekanisk Relaksation
Specialerapport udarbejdet af:
Johannes K. Nielsen, Klaus Dahl Jensen
Vejledere: Jeppe C. Dyre, Jørgen Larsen
- 304a/95 STATISTIKNOTER Simple binomialfordelingsmodeller
af: Jørgen Larsen
- 304b/95 STATISTIKNOTER Simple normalfordelingsmodeller
af: Jørgen Larsen
- 304c/95 STATISTIKNOTER Simple Poissonfordelingsmodeller
af: Jørgen Larsen
- 304d/95 STATISTIKNOTER Simple multinomialfordelingsmodeller
af: Jørgen Larsen
- 304e/95 STATISTIKNOTER Mindre matematisk-statistisk opslagsvær
indeholdende bl.a. ordforklaringer, resuméer og
tabeller
af: Jørgen Larsen

305/95 The Maslov Index:
A Functional Analytical Definition
And The Spectral Flow Formula
By: B. Booss-Bavnbek, K. Furutani

306/95 Goals of mathematics teaching -
Preprint of a chapter for the forth-
coming International Handbook of
Mathematics Education (Alan J. Bishop, ed)
By: Mogens Niss

TEKST NR 363

1999

**EMERGENCE AND
DOWNWARD CAUSA-
TION**

**by Donald T. Campbell, Mark
H. Bickhard, and
Peder V. Christiansen**

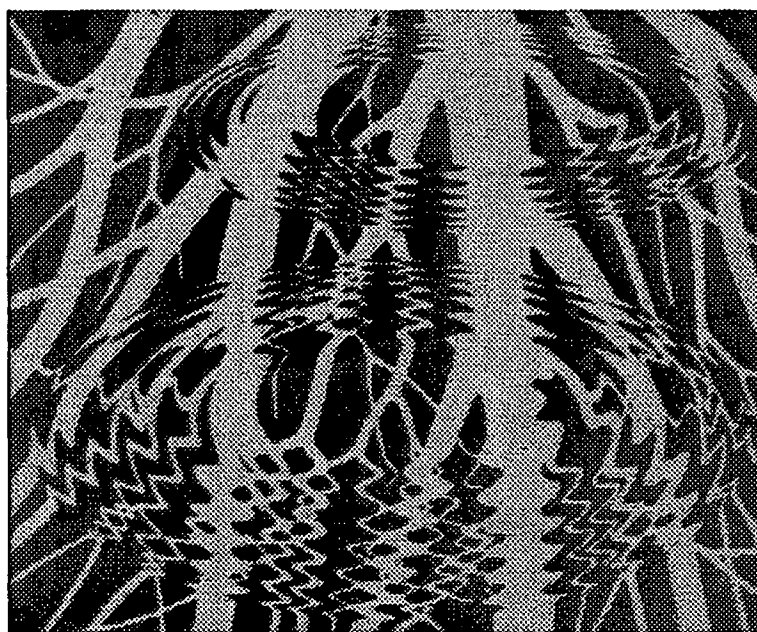

TEKSTER fra

IMFUFA

ROSKILDE UNIVERSITETSCENTER
INSTITUT FOR STUDIET AF MATEMATIK OG FYSIK SAMT DERES
FUNKTIONER I UNDERVISNING, FORSKNING OG ANVENDELSER

IMFUFA, Roskilde Universitetscenter, Postbox260,4000 Roskilde
Emergence and Downward causation by: Donald T. Campbell, Mark H. Bickhard, and Peder
Voetmann Christiansen IMFUFA tekst nr. 363/ 99 53 pages ISSN 0106 6242

Abstract

This preprint contains two articles from the collection "Downward Causation" (in preparation to be published by Aarhus University Press).

The collection contains views from many different academic disciplines (literature, media science, history, social science, psychology, biology, and physics).

The two papers presented here are mostly related to physics. The first article (M.B.H. & D.T.C.)

treats the subject "Emergence" from a philosophical and field-theoretical point of view, whereas the second (P.V.C.) is more specific about the emergence of *surfaces* considered as the first step in the *semiosis* of inorganic nature.

Cover- illustration: "rippled surface" by M.C. Escher. Lino-cut, 1950.

Acknowledgements

The editor of this preprint (PVC) wishes to thank the other members of the editorial board, Peter Bøgh Andersen, Niels Ole Finnemann, and Claus Emmeche for good initiatives and cooperation, also thanks to the author Mark H. Bickhard for allowing the inclusion of his paper (with excuses for possible editorial errors). Finally, thanks are due to Jesper Hoffmeyer for inspiration and useful suggestions.

Roskilde, february 1999, Peder Voetmann Christiansen

Contents:

Mark H. Bickhard with Donald T. Campbell

Emergence

Foreword by Mark H. Bickhard	p. 4
Abstract	p. 5
1. Reality or epiphenomenon	p. 6
2. Downward causation	p. 7
3. Hierarchy of levels	p. 9
4. Fields	p. 12
5. Supervenience	p. 14
6. Conclusion	p. 20
7. References	p. 21
8. Footnotes	p. 25

Peder Voetmann Christiansen

Downward Causation

From macro- to micro-levels in physics	p. 28
p. 28	
Abstract	p. 28
1. Wholes and parts	p. 29
2. Irreversibility and noise	p. 32
3. The emergence of boundaries	p. 36
4. Notes and references	p. 43
Appendix:	
Van der Waals' equation of state	p. 44
1. Virials and van der Waals	p. 44
2. Reduced variables and corresponding states	p. 46
3. The pressure of saturated vapour	p. 48
4. Cusp and control-parameters	p. 50

Foreword by Mark H. Bickhard

***Mark H. Bickhard**

Department of Philosophy 15 University Drive Lehigh University Bethlehem, PA
18015 610-758-3633 office 610-758-3775 philosophy deptmhb0@lehigh.edu
<http://www.lehigh.edu/~mhb0/mhb0.html>

***Donald T. Campbell**

University Professor of Social Relations and Psychology Sociology and Anth-
ropology 681 Taylor Street Lehigh University Bethlehem, PA 18015-3169

Deepest thanks are due to the Henry R. Luce Foundation for support to Mark Bickhard during the preparation of this paper.* This paper was to have been written jointly with Don Campbell. His tragic death on May 6, 1996, occurred before we had been able to do much planning for the paper. As a result, this is undoubtedly a very different paper than if Don and I had written it together, and, undoubtedly, not as good a paper. Nevertheless, I believe it maintains at least the spirit of what we had discussed. Clearly, all errors are mine alone.

Draft: 10 Jul 96; 29 Sep 96; 11 Oct 96; 2 Nov 96; 20 Dec 96

Emergence

Mark H. Bickhard with Donald T. Campbell

Abstract

Accounting for emergence has proved to be extraordinarily difficult, so much so that whether or not genuine emergence exists seems still in doubt. I argue that this difficulty is primarily due to an assumption of a false and inappropriate metaphysics in analyses of emergence. In particular, common assumptions of various kinds of substance metaphysics make the notion of causally efficacious emergence seriously problematic, if not impossible. There are, however, many problems with substance metaphysics — arguably fatal problems — and an alternative process metaphysics makes causally efficacious emergence much more natural.

1. reality or epiphenomenon

Consider a kitchen table. A table appears to be an entity in its own right — large, with a particular shape, solid, capable of supporting smaller objects, and so on. — But we also assume that it is made of molecules, and, in turn, atoms, and, in further turn, various subatomic particles. Perhaps the only physical reality is the swarm of quarks, gluons, and electrons that make up the table, and all of the other properties, of solidity, shape, and so on, are no more than manifestations of the interactions among those particles. Perhaps the properties of the table, and even the existence of a distinct object that we call a table, are all just epiphenomenal to the fundamental particle interactions. This is epiphenomenality in the sense of an appearance being false about underlying reality, such as the apparent motion of objects when watching a movie, when all that is *really* happening is a rapid succession of still pictures that happen to be sufficiently similar to each other to give an impression, a strictly false impression, of objects and people and caused motion. Perhaps being solid, for example, is mere appearance, merely epiphenomenal, from the level of the fundamental particles. — Most of us would prefer that our experiences of tables not be false, not be merely epiphenomenal. It would be a strange world in which virtually all of our experiences were in fact false to reality. The issues become even more focused and interesting, however, when we consider not just tables, but living things, and things with minds — animals and other people — and, most especially, our own mind. The supposed lessons from science are just as strong about plants, animals, and minds, as about tables. It would be a strange person indeed who would feel satisfaction in the conviction that his or her own mind did not really exist, but was merely an epiphenomenal manifestation of fundamental particle interactions. We would like for tables and their properties to be real, as well as life and mind. But our best science suggests strongly that the world is integrated, that there are not different sorts of substances or fluids for every new kind of phenomena. We have learned that fire is not a substance phlogiston, heat is not a substance caloric, life is not due to vital fluid, and very few philosophers or scientists today are substance dualists about mind compared to matter. Instead, these phenomena are understood as the result — the natural result — of processes involving atoms and molecules that are familiar from other kinds of phenomena. Fire, heat, life, and so on, and, presumably, mind, are integrated with the rest of the natural world. Naturalism about the world is clearly the best bet. But, so long as naturalism seems to suggest that the only real reality is basic particles, the apparent dilemma remains. Perhaps phenomena such as life and mind are somehow emergent out of lower level particles and processes. Perhaps they only exist insofar as those lower level particles and processes exist and occur, but they nevertheless have a reality of their own that

comes into being, that emerges, when certain patterns or quantities or some other threshold criterion is satisfied. And, furthermore, perhaps, the reality they have makes a difference. It is of little satisfaction if mind proves to be real in the sense of involving properties that genuinely exist, if those mental properties nevertheless have no causal power in the world, if they merely float along the basic particle interactions for the ride, but make no difference themselves. We all know in our own experience that mind, whatever it is, exists, but it would also be nice if our impressions of being able to make decisions and do things in the world are not themselves just epiphenomenal (Heil & Mele, 1993).

2. Downward causation

So, for emergence to do what we would want it to do, we need not only emergent instances of properties, but the emergence of properties or entities or processes that have genuine causal powers. It has proven remarkably difficult to make good on these intuitions of emergence. The inexorable reality of quantum particles keeps grabbing all of the causal powers, leaving nothing for purported emergents. Perhaps we must simply accept this apparent lesson of contemporary science — that we ourselves are mere epiphenomena. I will be arguing that genuine emergence does exist, and that the difficulties encountered in trying to make sense of it have been exacerbated by the presupposition of a false metaphysics — a metaphysics of substances (particles) and properties. There are good reasons to abandon such a metaphysical framework, and to substitute a process metaphysics. In this alternative process metaphysical framework, the possibility of emergence, including genuine causally efficacious emergence, is found to be trivial — the in-principle mystery of emergence is dissolved. Accounting for any particular emergence, however, such as that of mind, remains a deep, complex, and difficult problem. The intuition of emergence is that of novel causal powers coming into being at specific levels of ontology (Beckermann, Flohr, & Kim, 1992; Beckermann, 1992b; Hooker, 1979, 1981a, 1981b, 1981c). The causal powers of purported emergents are the focus of much concern (Campbell, D. T., 1974b, 1990; Kim, 1992a, 1993b), but the criteria of novelty and the notion of levels are also of importance and interest (Wimsatt, 1976a, 1976b). I will have a few things to say about each of them, and begin with novelty. Novelty The novelty of emergents, or potential emergents, can be construed with respect to time or with respect to ontology (Stephan, 1992). Emergents in time — in history or evolution or cosmology, for example — are simply the first occurrences of whatever the emergent is claimed to be. Emergence in ontology is the stronger concept, and refers to something new coming into being with each instance of some level or pattern of lower level constituents. The two construals are closely related in that, on naturalistic

accounts, temporal emergents would be the first instances of particular ontological emergents; conversely, an ontological emergent would be a temporal emergent the first time an instance appeared. The emergence of novelty per se, at least in the sense of novel properties, seems uninterestingly trivial. There was presumably a first time for the cosmological emergence of an instance of the shape *rectangle* or the configuration of one thing being *above* something else. Among other requirements, these had to await the *emergence* of entities out of the original superhot fields of the Big Bang, and, for the relationship of *above* presumably the aggregation of a mass with a significant gravitational field so that the directions of *up* and *down* would be determined. But the simplicity with which such a criterion of novel property emergence can be met seems to render it almost nugatory, and, correspondingly, novelty is generally considered to be a weak necessary criterion with little intrinsic interest. If we turn the novelty criterion around, however, and consider it not just a requirement to be able to account for something new — anything — coming into being, but, rather, consider that most everything we are scientifically interested in did not exist at the moment of the Big Bang, and, therefore, that most everything we are scientifically interested in had to emerge since that time, novel emergence can become a very powerful negative criterion. In particular, any purported model of X — for any phenomena X — that cannot account for the historical and ontological emergence of X since the Big Bang is thereby at best incomplete. More importantly, any model of X that makes the emergence of X impossible is thereby refuted. This holds even if we ignore any issues regarding the causal status of X, though, of course, in most cases of scientific interest, X presumably will have some causal status. Contemporary models of cognitive representation, for example, generally begin with some set of representational atoms, each with its own representational content, and attempt to account for all representation as various combinations of these atoms. But such models cannot, in principle, account for the emergence of the representational atoms themselves. The attempts to account for representation (combinations) already presupposes representations (atoms). There are rejoinders to such a claim, of course, and the issues are not trivial, but this characterization of the current scene is at least *prima facie* correct, and I argue that it is in fact deeply correct of symbol models, causal models, information models, current functional models, and connectionist models alike (Bickhard, 1993; Bickhard & Terveen, 1995). If so, this inability in-principle to account for the emergence of representation refutes these models of representation. In any case, this characterization of current models of representation well could be correct, and that is all that I need at this moment to illustrate the potential power of emergence, even of just novelty, as a principle by which theories and models can be evaluated. Any theory of X must be at least consistent with the emergence of X or else it commits a

non-naturalism of cosmology. If X cannot have historically emerged, then either it existed from the beginning or it was non-naturally introduced. Our best current science tells us that nothing familiar existed from the beginning, and that nothing was non-naturalistically introduced. Consistency with the possibility of emergence, then, is a scientifically necessary requirement — given contemporary science — as well as a powerful metaphysical requirement, for any model of any phenomena. Causality

But this is *just* a requirement to be able to account for the novel emergence of X, because there was a time at which X did not exist. If X supposedly has any causal powers of its own, then accounting for X must account not only for its cosmological and ontological novelty, but also for those emergent causal powers. This has been the focus of most of the concern about what emergence is and whether it exists or not — can genuine, and genuinely novel, causal powers emerge? Emergence presupposes a notion of levels. The universe at its origin was a superhot flux of quantum fields; everything since then is the result of condensation, symmetry breaking, and organization out of that original flux, sometimes with clear hierarchical levels of organization. Quark excitations stabilize in combination with other such excitations into nucleons, which combine with electrons to form atoms, which combine chemically to form molecules, which combine gravitationally to form planets or in derivative chemical ways to form rocks, water, cats, humans, and, presumably, minds. This hierarchy of levels is one of the inspirations for the intuition of emergence: maybe everything has arisen in at least a generally similar way. Note that successively higher levels often require successively lower temperatures to emerge. Downward Causation. If causal powers do emerge, then, within the framework of any reasonable naturalism, any causal consequences of those higher level emergent powers will themselves involve constituent levels of matter, or at least constituent levels of organizations of quantum processes. That is, any consequences of emergent causality will affect lower levels, constituent levels, of pattern and organization as well as the level at which the emergence occurs. More concisely, *causal emergence implies downward causation* (Campbell, D. T., 1974b, 1990; Hooker, 1979, 1981a, 1981b, 1981c; Kim, 1992a).

3. Hierarchy of levels

Since *interesting* emergence involves causal emergence, and causal emergence implies downward causation, downward causation becomes a strong criterion for genuine causal emergence and for interesting emergence more generally. Levels? Emergence involves higher levels, but what constitutes the difference between

higher and lower? What counts as a level? These questions lead in several directions, one of which I will focus on in particular. Note first, however, that the paradigmatic hierarchy of ever higher levels traces progressively lower temperatures of emergence and stability. Each level *condenses* out of lower levels with weaker forces, and, therefore, are stable and persistent in time only at lower temperatures. For at least some levels, such a differentiation of energy regimes in which stability is possible might seem to be definitive of the levels, though not necessarily of the particular kinds of emergents at those levels. This temperature differentiation of emergence levels, however, ultimately proves unsatisfactory. *Higher* levels might exhibit stability in the same temperature regime as constituent levels, such as for strictly mechanical machinery, or even manifest stability at higher energy levels. If, for example, an organism can protect itself against high temperatures, perhaps with perspiration and the production of heat shock molecules, the whole organism may remain viable at ambient temperatures at which isolated proteins would denature. The strong intuition about the nature of levels remains that of ontological inclusiveness: higher levels include lower levels as constituents — regardless of the energy realms for stability. Later I will argue that even this seemingly most basic sense of levels is flawed.

A Logical Point. Emergence seems *prima facie* to be in conflict with naturalism. Higher levels of organization or constituency would seem to have whatever properties they have solely in virtue of those constituents and the relationships among them. If there were anything emergent beyond that, it could not be causally efficacious on pain of violating the completeness of the account of the physical world at those lower levels. One powerful way of putting this is to point out a problem: If the lower level includes everything that is physically — causally — relevant, then higher level emergence can be causally efficacious only at the cost of violating the causal closure of the physical world (Kim, 1993a, 1993b). Such a result seems wildly non-naturalistic and something to be resisted. But if causal emergence yields such a result, then perhaps causal emergence too should be resisted. *On the other hand, there are certainly laws of regularity of causal efficacy that emerge at higher levels of pattern or organization — e.g., atomic stability and chemical valence (Hooker, 1981c)— that cannot be deduced from lower level laws alone. The pattern or organization of the constituents, minimally, is also required. One aspect of the issue of what counts as higher and what belongs to lower, then, focuses on such patterns and organizations. They constitute initial and boundary conditions with respect to lower level laws, and they are necessary to be able to account for higher level causal properties (Hooker, 1981c; Kfppers, 1992). Should they be included as part of the lower level, in which case we again face the consequence that any resultant causal properties will be counted as not emergent? Or should they be counted as constituting (part of?) the higher level, in which case novel causal*

properties clearly do emerge (van Gulick, 1992)? In part this is a stipulative difference, and our preferential stipulation will depend on how strong or weak a notion of emergence we wish to consider (Beckermann, 1992a; Horgan, 1993a; Hoyningen-Huene, 1992, 1994; McLaughlin, 1992; O'Connor, 1994; Stephan, 1992; Stücker, 1991). *Within* the perspective developed to this point, our choice of which seemingly arbitrary stipulation to make might depend most reasonably on what is at stake. Neither choice violates naturalism; countenancing emergence, however — counting pattern as *higher* — fits our naive intuitions and shields the causal efficacy of, for example, emergent mind, which most of us would probably appreciate. So, perhaps the best of all possibilities is to accept a conception of emergence that accepts causal-property resultants of organization as of higher level, and, therefore, emergent: we retain naturalism, emergence, and the causal reality of, among other considerations, mind. *Ultimate Reality: Microcausation?* But is the situation that simple? It seems reasonable within its own framework, but, even accepting emergence as the result, for example, of organizational boundary conditions on the manifestations of lower level laws, there nevertheless remains a strong seduction toward the conclusion that all real causality occurs only at the ultimate level of physical reality, presumably some class of fundamental particles (Kim, 1989, 1990, 1991, 1992b, 1993a, 1993b; Klee, 1984). In this view, the *merely* stipulative distinction between whether to count organization as part of higher or lower levels may usefully diagnose issues concerning relatively higher and lower levels where all levels under consideration are higher with respect to ultimate micro-levels, but it does not even address considerations that might privilege that ultimate micro-level itself above all other levels. It may be the case that particular consequences in the world depend on initial and boundary configurations, patterns, and organizations of fundamental particles, but, it might seem, all genuine causality occurs, and only occurs, at this ultimate level of particle mechanics. However much it may be the case that the outcome of causality depends on the patterns in which it works its causal consequences, nevertheless the only causal powers extant are those of these basic particles. So, all other lawful regularities, at whatever level of *emergence*, are really just *supervenient* on and epiphenomenal with respect to that basic level. Of course it is necessary to take into account the space-time configurations within which basic particle mechanics plays out its causal dance, but the only genuine causality is in the interactions among those particles. Causal consequences may depend on higher level patterns, but the only causal powers are those of fundamental particles. This is *prima facie* an extremely attractive picture. Its conceptual attractiveness is not diminished at all by the recognition that particular kinds of initial or boundary conditions can reliably yield particular kinds of regularities of consequences, and that these can look like emergents. All that follows from the view of ultimate reality being ultimate microcausation; it is not

it is not in contradiction to it. So, no matter the analysis of the distinction between relatively higher and lower levels, and no matter the semantic choices made about what counts as higher and what as lower, this view remains as a continual deflator of pretensions of emergence. What might appear to be emergence is really just basic, very micro-, particles interacting with each other.

4.Fields.

But, such particles are not all there is. There are also fields, and, in particular, quantum fields. Quantum field theory yields a very different picture than that of micro-particle mechanics. Quantum fields yield non-local interactions, such as result in the Pauli exclusion principle. Note in contrast that, in the particle picture, all causality is itself atomized to the very local points of particle to particle encounters. Quantum field theory yields a continuum of never ending activity, of process, even in a vacuum (Aitchison, 1985; Bickhard, in preparation-c; Brown & HarrÄ, 1988; Saunders & Brown, 1991). The background is not one of nothing happening except geodesic motion and local particle encounters — of an inert stage for particle mechanics — but, rather, a background of seething continuous creation and annihilation of quantum excitations of the field with various symmetries, therefore conservations, constraining the interrelationships within this activity. Ontology is not atomized to particles on a space and time stage, and cause is not atomized to points of particle encounters. In fact, there are no particles. Quantum field theory yields the conclusion that everything is quantum field processes (Brown & HarrÄ, 1988; Davies, 1984; Weinberg, 1977, 1995, 1996; Saunders & Brown, 1991). What appear to be particles are the consequences of the quantization of field excitatory activity, which is no more a particle than is the quantization of the number of waves in a vibrating guitar string. To illustrate the *reality* of this continuum of non-particle field processes, consider what is known as the Casimir effect. Two conducting plates held close together in a vacuum will inhibit the *virtual* excitations between the plates because the waves of those excitations will be constrained by the physical distance between the plates. There is no such inhibition of the foam of virtual creations outside of that gap. Therefore vacuum activity between the plates will be less than outside of the gap, and this results in a difference of pressure exerted on those plates. The net effect is a force pushing the plates toward each other, which has been experimentally verified (Aitchison, 1985; Sciama, 1991; Weinberg, 1995). Note that this force does not involve any particles; instead it is the result of that continuum of vacuum activity that is so unlike the atomization of substance and cause in the standard view. Quantum field theory eliminates the localization and atomization of substance into particles, the localization and atomization of cause into particle encounters, and the localization and atomization of levels of systems into objects. Everything is organizations of quantum processes (van Gulick, 1993); causality

is constraints on that quantum field activity, such as those that yield momentum or energy conservation (Aitchison & Hey, 1989; Bickhard, in preparation-c; Kaku, 1993; Ryder, 1985; Nakahara, 1992; Sudbery, 1986; Weinberg, 1995). In this view, everything is organization of process. There is no ultimate level of *real* particles on which everything else is supervenient, and with respect to which everything else is epiphenomenal. So that seduction is eliminated. The ultimate level of micro-particle micro-causation does not exist. It might seem that the micro-causation argument against emergence could simply be recast with respect to quantum fields instead of particles: the only reality is quantum fields, and everything else is epiphenomenal to that. The first part of this point is correct: everything is quantum field processes. But the critical point is that quantum field processes have no existence independent of configuration of process: quantum fields are process and can only exist in various patterns. Those patterns will be of many different physical and temporal scales, but they are all equally patterns of quantum field process. Therefore, there is no *bottoming out* level in quantum field theory — it is patterns of process all the way down, and all the way up. Consequently, there is no rationale for delegitimizing larger scale, hierarchical, patterns of process — such as will constitute living things, minds, and so on. That is, quantum field theory is an antidote to the seduction of including all patterns in the *supervenience base*, and, therefore, not counting properties that are dependent on perhaps complex patterns as constituting any kind of emergence. The point of quantum field theory in this discussion is to eliminate the temptation to devalue pattern so that pattern does not support emergence. In quantum field theory, pattern is everything because there is no level at which something unique and bottoming out, e.g., particles, can be found. It is, therefore, at best incomplete to say that everything is quantum fields: everything is organizations of quantum field processes — at many different scales and hierarchical complexities. Micro- and macro- alike are such organizations. — This resurrects the possibility of choosing to consider manifestations of organizational boundary conditions as of higher level, thereby resurrecting a naturalized emergence. More correctly, the recognition that everything is organization of process — just at differing scales and with differing hierarchical organizations — makes the choice to consider pattern and organization as of lower level, and thus to render properties of those patterns and organizations as epiphenomenal, a choice that renders everything epiphenomenal because there is no level at which anything is other than an organization of quantum field process, including even the smallest scale quantum fluctuations. The choice between countenancing organizational emergence and not countenancing it, then, is no longer arbitrary: to reject this form of emergence is to eliminate any level of non-epiphenomenality. That would seem to be a *reductio ad absurdum* of that position. In particular, in quantum field theory (or any process metaphysics),

there is no basis for excluding pattern from supporting emergence because everything is equally pattern, including higher level things such as minds. Minds cannot be *merely* epiphenomenal unless everything is taken to be epiphenomenal *because* there is nothing else that can be privileged in the metaphysics other than pattern, and there is no inherent reason to privilege any particular scale of such pattern over any other. *But* the consequences of shifting to a quantum field view ramify more densely and more distantly than emergence per se, and at least some of those further consequences need to be examined lest we implicitly presuppose a micro-atomization ontology even while explicitly rejecting it.

5. Supervenience

Notions of supervenience are attempts to distill the intuition that higher level properties depend on lower level properties. No change at the higher level without a concomitant change at the lower is the motto. There are importantly different varieties of attempts at explication of this intuition, but the issues that I want to focus on seem to be in common at least to both weak and strong supervenience (Kim, 1990). The lower level of a supervenience dependency, the supervenience base, must include both lower level constituents and relationships between them. *Sphere* is not supervenient on two hemispheres that are physically distant from each other, but would be supervenient on precisely the same constituents if they were in the proper physical relationship with each other (Baker, 1993). A supervenience base, however, does not include any relations external to the unit or system being considered. The property of being the longest pencil in the box, for example, is not supervenient on the molecules and internal relations that make up that pencil (Teller, 1992). By adding a new longer pencil to the box, the original pencil ceases to have that property, yet nothing of the supervenience base has changed. The property of being the longest pencil in a box is not of great independent interest, but there are other properties that are of deep importance that are similarly externally relational. Global quantum field constraints, such as the exclusion principle or a conservation constraint applying across spatially separated parts of a quantum system, are externally relational — they are not local. The property of being in thermodynamic equilibrium is relational to the environment, and so, consequently, is the property of being a far-from-equilibrium system. Necessarily open systems are those that are inherently far-from-equilibrium, and, therefore, require constant or at least intermittent interaction with an environment to be able to exist over time — otherwise they move to equilibrium and the far-from-equilibrium system ceases to exist. This implies that far-from-equilibrium systems, and all of the properties that they have qua far-from-equilibrium systems, are externally relational and, therefore, cannot be supervenient in the standard sense. *A flame,*

for example, is not supervenient: its existence is dependent on its environment (adequate oxygen, not too low a temperature, and so on) as well as on its own constituents *per se*. Furthermore, its supposed supervenience base is constantly changing, and any supposed micro-particle base is similarly in constant flux. The only persistence that constitutes the persistence of the flame is a persistence of an organization of process, not of the constituents that undergo that process. That organization of process, in turn, can be persistent only if appropriate transactions with the environment are possible and do in fact continue, such as inflows of oxygen and fuel vapor and outflows of combustion products. Conversely, if the constituents of a flame at a particular point in time were frozen — literally — then the supervenience base would remain the same, but there would no longer be a flame. Other even more important examples of far-from-equilibrium systems, and, therefore, of the limitations of the supervenience explications, are living things and minds. The supervenience intuition seems strong: higher levels depend on lower levels. But far-from-equilibrium systems constitute counterexamples to any presumed general applicability of supervenience as currently explicated. What is the source of the problem? Supervenience is explicated in terms of entities — particles — and properties (Kim, 1989, 1990, 1993b). This is basically an Aristotelian metaphysics, and is an inadequate metaphysics for relationships and process, most especially open process. *Entities* that are organizations of underlying far-from-equilibrium process are not supervenient so long as supervenience discounts external relations, and so long as it counts lower level constituents as part of the supervenience base. Flames, waves, vortices — none are supervenient on underlying constituents. They are more like knots or twists in an underlying flow — nothing remains persistent other than the organization of the knot itself. They are topological entities, not substantive entities. *Living* cells may contain structures that are in equilibrium stability, at least on relatively short time scales, but remaining alive requires continuous maintenance of far-from-equilibrium conditions, and, therefore, continuous flow and exchange with the environment. *Living*, then, is not a supervenient property: it is externally relational, and it requires a continuous flow of constituents. I argue that normativity, from functional normativity (functional - dysfunctional) to representational normativity (true - false) (Bickhard, 1993) and on up through rationality (Bickhard, forthcoming) and ethics (Bickhard, in preparation-a), is dependent on far-from-equilibrium systems properties. If this is so, or even if it is plausible, then the stakes involved in overlooking the inability of constituent and property based explications of supervenience to apply to far-from-equilibrium systems are quite serious. The sense in which everything is organization of quantum process, then, is even deeper than might at first appear. A first temptation in understanding *organization of process* is a constancy of constituents — particles — engaged in some motions and interac-

tions; perhaps particles running around each other to form an atom. But far more important are organizations of process that have no constituents, or certainly no unchanging constituents. The organization is everything; the constituents either do not exist or are not part of the supervenience base. Quantum field theory suggests that there are no constituents in the classical sense at any level. There are only certain wave properties that are maintained in the flux of quantum vacuum activity, like a soliton wave in water, but for which the vacuum takes the place of water. What we normally consider as constituents, as particles or entities, are persistences of instances of organizations of underlying quantum process: they are topological. If those persistences are due to equilibrium stabilities, then we have classical paradigm cases such as atoms for which it is easy to overlook that quantum field nature, thus process nature, of even the electrons and quarks. If those persistences are far-from-equilibrium system persistences, then we must look elsewhere than equilibrium to understand such persistence, and the relevance of external relations is directly manifest; the basic reality of the organization of process, relatively independent of whatever engages in that process, is more likely to be forced on us. The dependence of higher on lower, then, remains. But the explication of supervenience as attempts to capture that dependence must relinquish the conception of the supervenience base as involving particular constituents and their internal relations. The types of the instances of lower level process patterns involved may be important — e.g., oxygen rather than nitrogen for a flame — but the dependence on the identities cannot remain. Furthermore, dependence cannot be simply mereological even with that modification: among other reasons, the necessity of external relationships must be accommodated. A vortex in a flow cannot exist if the flow itself does not exist. Note that this view not only eliminates the localization and atomization of substance (substance disappears) and causality (point-localized particle encounters), but also of entities. Waves do not have definite boundaries; neither do flames, vortexes, and so on. A thorough and deep de-localization and de-atomization is required. We do not have an acceptable and well understood metaphysics of this sort. In this view, the possibility of emergence, even causally efficacious emergence, is — at least in principle — trivial. There is no mystery, no non-naturalism. Everything is process organization, and, therefore, every causal property is a property of process organization. Higher levels and lower levels alike are levels of the organization of process. There cannot be the temptation, therefore, to privilege the constituents at the lower level, or even at some ultimate level, because there are no particles, and even lower level instances of process organizations may be in constant flux. It's pattern and organization all the way down. *So a higher level causal emergent is just as legitimate as a lower level causal emergent.* Accounting for the emergence and causal efficacy of any particular kind of phenomena, of course, can still be of

causal efficacy of any particular kind of phenomena, of course, can still be of enormous difficulty and complexity, but the impossibility in principle of any such emergence that a substance metaphysics yields (no new substances can emerge within a substance metaphysics, only combinations or blends of the basic substances can occur) is eliminated. At least in principle, in this view, the possibility of causally efficacious emergence is trivial, though the specifics of any particular emergence may well not be. Reduction and Anti-reduction. A particle and property metaphysics tempts us to think that the only real causality is found at the micro-particle level. If so, then anything that is a resultant of those particle interactions working their way within some initial or boundary condition constraints is most fundamentally due to those particle causal powers and particle interactions. Everything else is epiphenomenal to that, and can be eliminatively reduced to it — perhaps with the caveat of the cognitive limitations of human beings to handle the complexities required. In this view, higher levels are necessary considerations only because of their relative cognitive simplicity for humans, not for any metaphysical or even physical reasons. Common sorts of rejections of such eliminative reductionist conclusions include the claim of multiple realizability of the higher level in the lower level and of cross-cutting kinds from higher to lower. The central point in such objections to eliminative reduction is that higher properties (or kinds) cannot always be eliminated in favor of lower properties (or kinds) because there can be multiple ways — perhaps unbounded or infinite numbers of ways — in which the higher level can be realized in the lower. The necessary correspondences between higher properties (kinds) and lower, then, do not hold. There are an unbounded number of ways to physically construct a computer, and therefore being a computer cannot be defined in terms of any of them. The disputes in this area turn on what counts as a property or kind, in particular whether or not disjunctions of properties or kinds are themselves legitimate properties or kinds, on the nature of laws, and the relationship among laws, properties, and kinds, and so on (Burge, 1989, 1993; Fodor, 1981; Kim, 1989, 1990, 1992b, 1993b; van Gulick, 1989). If, for example, potentially unbounded disjunctions of kinds are legitimate kinds, then what it is to be a computer can be defined in terms of the disjunction of all of the physically possible ways that one could be realized. So long, however, as the temptation remains to grant ultimate reality only to an ultimate micro-particle level of reality, it seems that the issue regarding reduction is foregone. Metaphysically everything is either at the micro-particle level, or else it is epiphenomenal and reducible to that level. Human cognitive limitations may require consideration of higher level epiphenomena because they are simpler, but they have no more metaphysical reality than that. In the quantum process view, however, issues of multiple realizability and cross-cutting kinds still exist, but they exist as issues of what sorts of organizations of what sorts of

process organization instances will yield particular emergent properties. Computers can be silicon, vacuum tubes, fluidic, even mechanical (though they tend to be rather slow), so long as certain organizational relationships are realized. This is the same point as is made within a particle view, except that there is no temptation to eliminate everything above the level of fundamental particles — there aren't any. The organizational properties that constitute something as a computer are just as legitimate as those that constitute something as an atom or cell or brain. The special properties that emerge with each of these need to be accounted for — a decidedly non-trivial task — but there is no need to fend off possible eliminative reduction to fundamental particles. Even within a particle view, the organizational properties cannot be ignored. But in a process view, such organizational properties (perhaps richly hierarchical) are all that there is. There is no more basic or fundamental reality.

The Emergence of Properties and Entities Because everything is organization of process, every causally efficacious property is a property of organization of process. *The possibility of causally efficacious property emergence*, therefore, is assured. But what about entities? Particles have been eliminated, so entities cannot simply be combinations of particles. But how do we get to entities from properties and process organizations? Paradigm entities are stable instances of organizations of underlying process, such as atoms or animals. There are two kinds of such stability: 1) equilibrium or energy well stability, and 2) open process, far-from-equilibrium, stability. *Energy well stabilities* are those process patterns that would require energy input to destabilize them. They exist, or would exist, at thermodynamic equilibrium. So long as the ambient energy is not sufficient to destabilize them, to disrupt their cohesion (Collier, 1988, 1995), they will tend to persist. Atoms are a paradigm example. Necessarily open system stability, in contrast, cannot exist at equilibrium. Necessarily open systems are inherently far from equilibrium and cease to exist if they approach equilibrium. But approach equilibrium they inexorably will unless there are continuous exchanges with the environment that maintain the critical far-from-equilibrium conditions. The stability of far-from-equilibrium systems, then, depends on the stability of those conditions in the environment and relations to the environment that maintain the necessary far-from-equilibrium conditions. In some cases, all such conditions of stability are in the environment per se, and the system stability is completely dependent on that environment. A far-from-equilibrium system in which chemical solutions continuously flow into a container, for example, can exhibit fascinating properties (such as self-organization), but the stability of any such system is captured in the reservoirs and pumps for the chemical solutions, not the open system per se. A flame, in contrast, contributes to its own stability. It generates above-combustion-threshold temperatures, and, in an atmosphere and gravitational field, that yields convective inflow of oxygen and outflow of

combustion products. The heat also releases fuel vapor from the substrate, such as a piece of wood. The flame makes no contribution to the general availability of oxygen or fuel (though that might be disputed in the case of a fire storm), but it does contribute to the temperature requirement and to the local availability of oxygen and fuel and the dispersal of waste. I call such systems self-maintenant systems — they contribute to their own maintenance. Consider now a far-from-equilibrium system with the following general property: it has more than one way of being self-maintenant, and it can shift between or among available ways with at least some degree of appropriateness to what environmental conditions require. A bacterium, for example, might keep swimming if things are getting better, and tumble for a moment if they are not (Campbell, D. T., 1990). In conditions of *getting better*, keep swimming; in conditions of *getting worse*, randomize direction. Note that the switching between forms of contribution to self-maintenance requires some signal from the environment that can be used as an indication of which form is currently appropriate. I call such systems recursively self-maintenant — they tend to maintain (with respect to variations in the environment) their own condition of being self-maintenant (in those environments). I now want to offer some extremely inspissated outlines of how this framework might be able to account for some normative emergences. Note that a self-maintenant system either succeeds in maintaining system stability or it does not. If it does, the system remains stable in the world, and its causal consequences continue. If it does not, then the system ceases to exist, and its causal consequences qua that system cease. If the match flame has gone out, then the paper will not burn. The flame, then, serves a function (actually several) relative to the maintenance of the flame itself. And it makes a causal difference, an asymmetric difference, in the world whether or not that function is well served or not served. The difference between the flame existing or not existing is obvious; the asymmetry derives from the persistence of the relevant emergent properties if it continues, and the cessation of those emergent properties if it ceases. The asymmetry, then, derives from the asymmetry between the existence of open system emergents and the non-existence of those emergents — from the basic asymmetry between far-from-equilibrium and equilibrium. I claim that this is the general form in which function, and dysfunction, emerge. Function is contribution to self-maintenance, and is relative to the far-from-equilibrium system whose maintenance is in focus (Bickhard, 1993, in preparation-a). Note also that a recursively self-maintenant system could be wrong in its switching from one manner of self-maintenance to another. In particular, such a shift of process involves an implicit anticipation of subsequent self-maintenant interactions with the environment, but the environment may or may not cooperate. If the environment *misbehaves*, if things are actually getting worse for the bacterium in spite of continued swimming that is

supposed to make things better, then that implicit anticipation has been falsified. Furthermore, the system may be able to detect such a falsification: tumbling may be triggered yet again. In a more complicated system, perhaps a higher level signal (perhaps generated internally to the bacterium) *indicates* falsification even while the signal to switch from swimming to tumbling remains with the swimming. Any such higher level error signal would have to be a surrogate or vicariant for overall system stability in order for the *error* to be functionally genuine error for the system (Campbell, D. T., 1974a). But even the existence of such an error detector would do the bacterium no good unless that signal could in turn control or trigger some further self-maintaining process. It might, for example, shift to an entirely different set of interactive strategies for self-maintenance, or, in a much more complex system, such error signals may guide learning, not just subsequent behavior. My basic point, however, is that such implicit anticipations, and their potential falsification in and of and by the system itself, constitutes an emergence of truth value in the system itself. Truth value is one of the criteria, and a crucial and very difficult criterion to meet, for the emergence of representation. I argue, in fact, that such truth-valued anticipations constitute the most primitive form of emergent representation, out of which all other representation is differentiated and derived (Bickhard, 1993, in preparation-b). I have barely outlined these two claims of normative emergence, of function and of representation; I have not offered anything like an adequate argument for these particular emergents here. My point, however, is illustrative, not conclusive. My point is to illustrate a *prima facie* not-implausible possibility. Note that, in these models, function and representation emerge as properties of certain kinds of open, far-from-equilibrium, systems. That is, they emerge in certain kinds of organization of process. The possibility of their emergence, therefore, and of their causally efficacious emergence, is not precluded. Not precluded, of course, is not the same as *accounted for*. That requires the full arguments not presented here. But, for them to be not metaphysically precluded is already a large step beyond the intricate impossibilities yielded by standard particle and property metaphysics. As mentioned at the beginning of this paper, requiring that a model of X not preclude the emergence of X already rejects every model of representation *and function*; (Bickhard, in preparation-b) available in the contemporary literature.

6. Conclusion

The intuition that genuine causally efficacious emergence occurs — of mind, for example, especially yours or mine — is very strong. But serious difficulties have been encountered in trying to account for the mere possibility of any such emergence. I suggest that these difficulties are due to an inadequate and,

according to our best current science, false metaphysical framework that is presupposed in attempting those accounts. Within a more acceptable process metaphysics, the mere possibility of emergence is trivial, and the hard work of creating good models of actual emergents can proceed.

7. References

- Aitchison, I. J. R.** (1985). Nothing is Plenty: The vacuum in modern quantum field theory. *Contemporary Physics*, 26(4), 333-391. **Aitchison, I. J. R., Hey, A. J. G.** (1989). *Gauge Theories in Particle Physics*. Adam Hilger, **Anderson, P. W., Stein, D. L.** (1984). Broken Symmetry, Emergent Properties, Dissipative Structures, Life and Its Origin: Are They Related? In **Anderson, P. W.** *Basic Notions of Condensed Matter Physics*. (262-285). Benjamin/Cummings. **Atiyah, M.** (1987). *Michael Atiyah Collected Works*. Vol. 5: Gauge Theories. Oxford University Press. **Atiyah, M.** (1991). Topology of the Vacuum. In **S. Saunders, H. R. Brown** (Eds.) *The Philosophy of Vacuum*. (275-278). Oxford University Press. **Baker, L. R.** (1993). Metaphysics and Mental Causation. In **J. Heil, A. Mele** (Eds.) *Mental Causation*. (75-95). Oxford University Press. **Bechtel, W., Richardson, R. C.** (1992). Emergent Phenomena and Complex Systems. In **A. Beckermann, H. Flohr, J. Kim** (Eds.) *Emergence or Reduction? Essays on the Prospects of Nonreductive Physicalism*. (257-288). **Berlin, Walter de Gruyter.** **Beckermann, A.** (1992a). Introduction – Reductive and Nonreductive Physicalism. In **A. Beckermann, H. Flohr, J. Kim** (Eds.) *Emergence or Reduction? Essays on the Prospects of Nonreductive Physicalism*. (1-21). **Berlin, Walter de Gruyter.** **Beckermann, A.** (1992b). Supervenience, Emergence, and Reduction. In **A. Beckermann, H. Flohr, J. Kim** (Eds.) *Emergence or Reduction? Essays on the Prospects of Nonreductive Physicalism*. (94-118). . (1992). . **Berlin: Walter de Gruyter.** **Bickhard, M. H.** (1993). Representational Content in Humans and Machines. *Journal of Experimental and Theoretical Artificial Intelligence*, 5, 285-333. **Bickhard, M. H.** (forthcoming). Critical Principles: On the Negative Side of Rationality. In **Herfel, W., Hooker, C. A.** (Eds.) *Beyond Ruling Reason: Non-formal Approaches to Rationality.* **Bickhard, M. H.** (in preparation-a). *The Whole Person: Toward a Naturalism of Persons*. Harvard University Press. **Bickhard, M. H.** (in preparation-b). *Interaction and Representation.* **Bickhard, M. H.** (in preparation-c). *Variations in Variation and Selection: The Ubiquity of the Variation-and-Selective--Retention Ratchet in Emergent Organizational Complexity. Part II: Quantum Field Theory.* **Bickhard, M. H., Campbell, Donald T.** (in preparation). *Variations in Variation and Selection: The Ubiquity of the Variation-and-Selective-Retention Ratchet in Emergent Organizational Complexity.* **Bickhard, M. H., Terveen, L.** (1995). *Foundational Issues in Artificial Intelligence and Cognitive*

- Science Ð Impasse and Solution. Amsterdam: Elsevier Scientific.
- Broschart, J.** (1996). A Geometrical Model of the Emergence of Case Relations. Presented at the Conference on Functionalism and Formalism, University of Wisconsin; Milwaukee, Wisconsin; April 1996.
- Brown, H. R., & Harr , R.** (1988). Philosophical foundations of quantum field theory. Oxford: Oxford University Press.
- Burge, T.** (1989). Individuation and Causation in Psychology. *Pacific Philosophical Quarterly*, 70, 303-322.
- Burge, T.** (1993). Mind-Body Causation and Explanatory Practice. In **J. Heil, A. Mele** (Eds.) *Mental Causation*. (97-120). Oxford University Press.
- Campbell, D. T.** (1974a). Evolutionary Epistemology. In **P. A. Schilpp** (Ed.) *The Philosophy of Karl Popper*. (413-463). LaSalle, IL: Open Court.
- Campbell, D. T.** (1974b). 'Downward Causation' in Hierarchically Organized Biological Systems. In **F. J. Ayala, T. Dobzhansky** (Eds.) *Studies in the Philosophy of Biology*. (179-186). Berkeley, CA: University of California Press.
- Campbell, D. T.** (1990). Levels of Organization, Downward Causation, and the Selection-Theory Approach to Evolutionary Epistemology. In **Greenberg, G., & Tobach, E.** (Eds.) *Theories of the Evolution of Knowing*. (1-17). Hillsdale, NJ: Erlbaum.
- Careri, G.** (1984). Order and Disorder in Matter. Benjamin/Cummings.
- Chapman, D. and Agre, P.** (1986). Abstract reasoning as emergent from concrete activity. In **M. P. Georgeff, A. L. Lansky**, (Eds.) *Reasoning about Actions and Plans*, Proceedings of the 1986 Workshop. (411-424). San Francisco: Morgan Kaufmann.
- Cherian, S., Troxell, W. O.** (1995). Intelligent behavior in machines emerging from a collection of interactive control structures. *Computational Intelligence*, 11(4), 565-592. Blackwell Publishers. Cambridge, Mass. and Oxford, UK.
- Collier, J.** (1988). Supervenience and Reduction in Biological Hierarchies. In **M. Matthen, B. Linsky** (Eds.) *Philosophy and Biology: Supplementary Volume 14 of the Canadian Journal of Philosophy*, 209-234. University of Calgary Press.
- Collier, J. D.** (1995). Emergence in Natural Hierarchies.
- Davies, P. C. W.** (1984). Particles Do Not Exist. In **S. M. Christensen** (Ed.) *Quantum Theory of Gravity*. (66-77). Adam Hilger.
- Dijkgraaf, R., Witten, E.** (1990). Topological Gauge Theories and Group Cohomology. *Commun. Math. Phys.* 129, 393-429.
- Fodor, J. A.** (1981). Special Sciences. In **J. Fodor** *RePresentations* (127-145). Cambridge: MIT Press.
- Heil, J., Mele, A.** (1993). *Mental Causation*. Oxford University Press.
- Hooker, C. A.** (1979). Critical Notice. **R. M. Yoshida**: Reduction in the Physical Sciences. *Dialogue*, XVIII(1), 81-99.
- Hooker, C. A.** (1981a). Towards a General Theory of Reduction. Part I: Historical and Scientific Setting. *Dialogue*, XX, 38-59.
- Hooker, C. A.** (1981b). Towards a General Theory of Reduction. Part II: Identity and Reduction. *Dialogue*, XX, 201-236.
- Hooker, C. A.** (1981c). Towards a General Theory of Reduction. Part III: Cross-Categorical Reduction. *Dialogue*, XX, 496-529.
- Horgan, T.** (1993a).

From Supervenience to Superdupervenience: Meeting the Demands of a Material World. *Mind*, 102(408), 555-586. **Horgan, T** (1993b). Nonreductive Materialism and the Explanatory Autonomy of Psychology. In **S. J. Wagner, R. Warner** (Eds.) *Naturalism: A critical appraisal*. (295-320). University of Notre Dame Press. **Hoyningen-Huene, P.** (1992). On the Way to a Theory of Antireductionist Arguments. In **A. Beckermann, H. Flohr, J. Kim** (Eds.) *Emergence or Reduction? Essays on the Prospects of Nonreductive Physicalism*. (289-301). **Berlin, Walter de Gruyter.** **Hoyningen-Huene, P.** (1994). Zu Emergenz, Mikro- und Makro-determination./On Emergence, Micro-determination, and Macro-determination. In **W. Lfbbe** (Ed.) *Kausalität und Zurechnung*. **Berlin: De Gruyter.** **Kaku, M.** (1993). *Quantum Field Theory*. Oxford University Press. **Kauffman, L. H.** (1991). *Knots and Physics*. Singapore: World Scientific. **Kim, J.** (1989). The Myth of Nonreductive Materialism. *Proceedings and Addresses of the American Philosophical Association*, 63, 31-47. **Kim, J.** (1990). Supervenience as a Philosophical Concept. *Metaphilosophy*, 21(1-2), 1-27. **Kim, J.** (1991). Epiphenomenal and Supervenient Causation. In **D. M. Rosenthal** (Ed.) *The Nature of Mind*. (257-265). Oxford University Press. **Kim, J.** (1992a). *Downward Causation* in Emergentism and Non-reductive Physicalism. In **A. Beckermann, H. Flohr, J. Kim** (Eds.) *Emergence or Reduction? Essays on the Prospects of Nonreductive Physicalism*. (119-138). **Berlin, Walter de Gruyter.** **Kim, J.** (1992b). Multiple Realization and the Metaphysics of Reduction. *Philosophy and Phenomenological Research*, 52, 1-26. **Kim, J.** (1993a). *Supervenience and Mind*. Cambridge University Press. **Kim, J.** (1993b). The Non-Reductivist's Troubles with Mental Causation. In **J. Heil, A. Mele** (Eds.) *Mental Causation*. (189-210). Oxford University Press. **Klee, R. L.** (1984). Micro-Determinism and Concepts of Emergence. *Philosophy of Science*, 51, 44-63. **Kfppers, B.-O.** (1992). Understanding Complexity. In **A. Beckermann, H. Flohr, J. Kim** (Eds.) *Emergence or Reduction? Essays on the Prospects of Nonreductive Physicalism*. (241-256). **Berlin: Walter de Gruyter.** **LePore, E., Loewer, B.** (1987). Mind Matters. *Journal of Philosophy*, 84, 630-642. **LePore, E., Loewer, B.** (1989). More on Making Mind Matter. *Philosophical Topics*, XVII(1), 175-191. **Maes, P.** (1992). Learning Behavior Networks from Experience. In **F. J. Varela, P. Bourgin** (Eds.) *Toward A Practice of Autonomous Systems*. (48-57). Cambridge, MA: MIT Press. **McLaughlin, B. P.** (1992). The Rise and Fall of British Emergentism. In **A. Beckermann, H. Flohr, J. Kim** (Eds.) *Emergence or Reduction? Essays on the Prospects of Nonreductive Physicalism*. (49-93). **Berlin, Walter de Gruyter.** **Misner, C W., Thorne, K. S., Wheeler, J. A.** (1973). *Gravitation*. Freeman. **Nakahara, M.** (1992). *Geometry, Topology, and Physics*. Institute of Physics Publishing. **Newman, D. V.** (1996). Emergence and Strange Attractors. *Philosophy of Science*, 63(2), 245-261. **O'Connor, T.** (1994). Emergent

Properties. *American Philosophical Quarterly*, 31(2), 91-104. **Olson, K. R.** (1987). *An Essay on Facts*. Stanford, CA: Center for the Study of Language and Information. **Ryder, L. H.** (1985). *Quantum Field Theory*. Cambridge. **Saunders, S., Brown, H. R.** (1991). *The Philosophy of Vacuum*. Oxford University Press. **Sciama, D. W.** (1991). The Physical Significance of the Vacuum State of a Quantum Field. In **S. Saunders, H. R. Brown** (Eds.) *The Philosophy of Vacuum*. (137-158) Oxford University Press. **Stephan, A.** (1992). Emergence — A Systematic View on its Historical Facets. In **A. Beckermann, H. Flohr, J. Kim** (Eds.) *Emergence or Reduction? Essays on the Prospects of Nonreductive Physicalism*. (25-48). Berlin: Walter de Gruyter. **StÜckler, M.** (1991). A Short History of Emergence and Reductionism. In **E. Agazzi** (Ed.) *The Problem of Reductionism in Science*. (71-90). Dordrecht, NL: Kluwer Academic. **Sudbery, A.** (1986). *Quantum Mechanics and the Particles of Nature*. Cambridge. **Teller, P.** (1992). A Contemporary Look at Emergence. In **A. Beckermann, H. Flohr, J. Kim** (Eds.) *Emergence or Reduction? Essays on the Prospects of Nonreductive Physicalism*. (139-153). Berlin: Walter de Gruyter. **Van Gulick, R.** (1989). Metaphysical Arguments for Internalism and Why They Don't Work. In **S. Silvers** (Ed.) *Rerepresentation*. (151-159). Dordrecht: Kluwer Academic. **Van Gulick, R.** (1992). Nonreductive Materialism and the Nature of Intertheoretical Constraint. In **A. Beckermann, H. Flohr, J. Kim** (Eds.) *Emergence or Reduction? Essays on the Prospects of Nonreductive Physicalism*. (157-179). Berlin, Walter de Gruyter. **Van Gulick, R.** (1993). Who is in Charge Here? And Who is Doing All the Work? In **J. Heil, A. Mele** (Eds.) *Mental Causation*. (233-256). Oxford University Press. **Weinberg, S.** (1977). The Search for Unity, Notes for a History of Quantum Field Theory. *Daedalus*, 106(4), 17-35. **Weinberg, S.** (1995). *The Quantum Theory of Fields*. Vol. 1. Foundations. Cambridge. **Weinberg, S.** (1996). *The Quantum Theory of Fields*. Vol. II Modern Applications. Cambridge. **Wimsatt, W. C.** (1976a). Reductionism, levels of organization, and the mind-body problem. In **G. Globus, G. Maxwell, I. Savodnik** (Eds.) *Consciousness and the Brain*. Plenum. **Wimsatt, W. C.** (1976b). Reductive Explanation: A functional account. In **R. S. Cohen, C. A. Hooker, A. C. Michalos, J. Van Evra** (Eds.) *PSA-1974. Boston Studies in the Philosophy of Science*. (Vol. 32, pp. 671-710). Dordrecht: Reidel. **itten, E.** (1988). Topological Quantum Field Theory. *Communications in Mathematical Physics*, 117, 353-386. **itten, E.** (1989). Quantum Field Theory and the Jones Polynomial. *Communications in Mathematical Physics*, 121(3), 351-399.

8. Footnotes

British emergentists had a kind of organizational conception of what counted as lower, and still wanted to claim that something else could be emergent at the higher level (Beckermann, 1992a, 1992b; McLaughlin, 1992; Stephan, 1992; StÜckler, 1991). The emergent property supposedly came into being with particular organizations of constituents, but it was in-principle not derivable from lower level considerations. Such emergence was itself presumed to be part of the physical laws of the universe: under such and such organizational or patterns conditions, this new causal property comes into being. This position may constitute a physicalism, but it violates the non-ad-hoc-ness of naturalism.

There is an epistemological view of emergence that depends on higher level properties not being derivable from lower level considerations, as a distinct issue from that of whether or not the higher level properties are determined by lower level properties and relations (Hoyningen-Huene, 1992). In such a view, chaotic systems provide a clear kind of (epistemic) emergence in that their course over time is not calculable in-principle, even though it is completely determined. Among other consequences, this implies that it may not be determinable which of two or more different attractors a given system is or will be in because the attractors themselves or (inclusive) their basins of attraction may be chaotically mixed and not separable in any physically realistic sense (e.g., Newman, 1996). I find this to be an interesting conception of emergence, but it is not the one at issue in this paper. I am concerned with issues of ontological and physical emergence, not only epistemological unpredictability (Hooker, 1979, 1981a, 1981b, 1981c).

This would likely be considered to be too weak a notion of emergence by some — the British emergentists, for example. But the point of the concept of emergence is to differentiate novel causal powers. Causal powers that are in principle not derivable from lower causality and initial and boundary conditions would certainly be a kind of emergence — though likely an empty kind, and certainly an ad-hoc kind — but it is difficult to find a reasonable argument that this should be held as the only notion of emergence. Conversely, the point of reduction, at least in the sciences, is to reduce the number of ontological kinds necessary to understand the world, without necessarily prejudicing, and certainly without necessarily rejecting, the reality of at least some aggregations of instances of those kinds. Hooker, for example, distinguishes between ontological reality, which is a reality of ontological kinds, and physical reality, which can include aggregations of instances of those kinds. Ontological reduction can, in

ontological kinds are of sub-atomic particles (Hooker, 1979, 1981a, 1981b, 1981c). That is, ontological reduction of X does not necessarily carry the implication of the elimination of the reality of X. The key point would seem to be that of the existence of genuine emergent causal powers. If it were held that higher level physical systems might *exist*, but that their causal consequences were strictly a result of the working out of the causal powers of the fundamental particles that constituted them, then that physical existence might seem unacceptably pale and unsatisfying as a notion of emergence. This stance depends on a strong distinction between causal consequences and causal powers, because it is clear that differing organizations of particles will have, in general, differing causal consequences. So the issue is whether or not there are emergent causal powers, whatever those might be. The assumption that this distinction between consequences and powers makes sense, in turn, depends on the assumption that there exists something that bears those genuine causal powers — distinct from mere causal consequences. Fundamental particles are the obvious candidate for these bearers of ultimate causality. It is to this set of issues regarding causal powers that I now turn in the main text. Assuming that minds can be understood naturalistically as organizations of particular kinds of *processes*. It is arguable, incidentally, that the *basic particle* reduction picture is not just factually false, but it is also logically incoherent. For example, if the particles have no extension, then a field view is forced in order to account for particle interactions, since the probability of such particles ever actually hitting each other is zero. If particles have finite extension, however, then they pose problems of compressibility, velocity of transmission of force through their diameter, extreme difficulty in explaining differing kinds of interactions (gravity, electricity, etc.), and so on. If a move is made to a combination of particles and fields (the typical contemporary semi-sophisticated view), then all of the basic issues are already granted anyway in the granting of fields at all. Any field view destroys the seduction into a micro-particle reduction because configurational and organizational properties make differences in causal power, not just in the working out of lower order causal power. There are no particles, but, even if there were, so long as fields are granted at all, the microreduction motivation fails — and a strict particle view is not only factually false but conceptually incoherent as well. (It is worth pointing out that Special Relativity forces a field physics, and, thus, a field metaphysics.) Though it is not clear what is supposed to bear those internal relations. The syntactic assimilation of relations to properties as all being *just* N-adic predicates for varying Ns seems to have obscured the ontological problems that relations pose to any substance-property metaphysics (Olson, 1987). It is already clear that causally relevant properties are not necessarily local, and, therefore, not necessarily supervenient (Burge, 1989, 1993; LePore & Loewer, 1987, 1989; van Gulick, 1989). The point here

is an extension of that to the existence of certain kinds of systems — in particular, of far-from-equilibrium systems. For other discussions of inadequacies of the concept of supervenience, see Collier (1988) and Horgan (1993a, 1993b). And quantum field theory requires that all entities are topological entities, not substance entities. Topological entities are defined in terms of what classes of shapes can and cannot be continuously deformed into each other without breaking or tearing anything. A surface with one hole in it, for example, can be smoothly deformed into a teacup, but a surface with one hole in it cannot be smoothly deformed into a surface with two holes in it — something has to tear. Similarly, a sphere cannot be smoothly deformed into a torus (doughnut), and a simple loop cannot be smoothly deformed into a simple overhand knot (with the ends joined). Such considerations at the level of vacuum processes have proven to be central to quantum field theory (Atiyah, 1987, 1991; Dijkgraaf & Witten, 1990; L. Kaufmann, 1991; Weinberg, 1996; Witten, 1988, 1989). Clearly they are important at a macro-level: a flow with a vortex in it is causally different from a flow with no vortex. There exist, of course, questions about the nature of the vacuum processes which are (hierarchically) organized at so many different scales. That nature is largely unknown (Atiyah, 1991; Bickhard, in preparation-c; Brown & HarrÄ, 1988; Misner, Thorne, Wheeler, 1973; Saunders & Brown, 1991). But continuity, non-locality, and virtual excitations, for example, compel that that nature is not particle-like. The British emergentists notwithstanding, the scientific use of the concept of emergence fits quite well with this notion of emergence in organization, rather than some sort of emergence beyond anything non-ad-hoc attributable to organization (e.g., Anderson & Stein, 1984; Bechtel & Richardson, 1992; Broschart, 1996; Careri, 1984; Chapman & Agre, 1986; Cherian & Troxell, 1995; Maes, 1992). There is also a form of persistence of types of process organization that is the result of instances of that organizational type causing, or at least increasing the probability of, the creation of more instances of that organizational type, such as in auto-catalysis or reproduction. I will not address these here (Bickhard, 1993; Bickhard & Campbell, D. T., in preparation). The illustration leaves the realm of biological reality here. I haven't bothered to find out if any actual bacterium is capable of this. My point is more general, and this is illustration. *and of all other forms of normativity as well.*

Downward Causation
from macro- to micro-levels in physics

Abstract

Downward Causation in a physics-context is viewed as the influence of macroscopic boundary conditions on the microscopic dynamics of a thermodynamic system. Three cases are considered, corresponding to the three phenomenological categories of C.S. Peirce: **1:** The irreversible approach to the maximum entropy equilibrium state of a homogeneous phase. **2:** A symmetry-breaking phase transition (emergence) forming a separating boundary between two phases, like the surface of a liquid. **3:** adaptive behaviour associated with the surface-modes such as self-organized criticality.

1. Wholes and parts

The metaphorical use of the words "upward" and "downward" in connection with "causation" is generally understood as involving wholes and parts of a system. Thus, the system is a whole that is distinguished from its surroundings by certain boundary conditions, and inside the system we may find interacting parts. In general systems theory words like "inside" and "boundary" also have a metaphorical character: the system is not necessarily like a container in ordinary space; for example we may speak of the system of electrons in a metal as something separated from the system of elastic vibrations in the same metal, although the "boundary" separating these two systems does not have the character of the wall of a container but is a sort of energetical constraint that connect the two systems weakly throughout the three-dimensional space of the metal.

We shall, however, in this chapter mostly be concerned with systems that really are containers, e.g. a gas that is separated from its surroundings by a solid wall. The gas as a whole has certain properties, like volume, pressure, and temperature that are conditioned partly by the wall and partly by properties of its constituent molecules. Thus, if the wall is heat conducting (diathermic) we may assume that the temperature has a fixed value, determined by the temperature of the surroundings, and the pressure and volume have a reciprocal relation to each other, whereas, if the wall is heat-insulating (adiabatic) both pressure and temperature will change, when the volume of the container is changed. The boundary conditions in this way determine the laws on the macroscopic level of the whole, i.e. the thermodynamic relations that are appropriate to the system, and they restrict the motion of the microscopic parts. We can therefore say that the boundary conditions exert a "horizontal" and a "downward" causation. Also, it is clear that there is an "upward" causation in the system, because macroscopic properties, like the heat capacity of the system depends on microscopic features, like the shape and rigidity of the molecules.

One may say that the restricting influence of the walls on the motion of the molecules is not genuine downward causality, because the *laws* of molecular motion, like Newton's law of action and reaction, are unchanged by the walls. This, however, is a limited truth, because the boundary conditions determine *how* these laws are to be applied. We may state the law of action and reaction by saying that the force molecule A exerts on molecule B is equal in magnitude (but with opposite direction) to the force molecule B exerts on molecule A, but this law then presupposes that molecule A and B have individual existence, so that

they do not react chemically with each other and form a compound or split into other parts that are not identical with the original molecules, and whether such reactions take place or not is determined by the boundary conditions, e.g. whether the walls are rapidly changing their positions or whether they are able to conduct heat from surroundings with a sufficiently high temperature.

The temperature is the most important macroscopic property that determines what type of laws describes the dynamics on the microlevel. One may say that temperature determines what type of parts we may consider as having individual existence. An examination of the concept of an ideal gas will illustrate that.

At room temperature we may consider a quantity of atmospheric gas as consisting of rigid diatomic molecules that are able to move freely in the three dimensional space within the confinement of the walls and perform free rotations around their center of mass. Thus, each molecule has 5 degrees of freedom in their motion, namely three translational motions and two rotational, and each of these degrees of freedom contributes on the average with a fixed amount $\frac{1}{2}kT$ (where k is Boltzmann's constant and T the absolute temperature) to the total energy of the system (assuming that the interaction between molecules is weak). The heat capacity of the system is therefore $(5/2)k$ times the number of molecules.

When the temperature is raised the heat capacity begins to increase, because the molecules cease to be rigid. When the two atoms in a diatomic molecule are able to oscillate relative to each other there will be 6 degrees of freedom per molecule, and this is also the case when the temperature induced oscillations become so violent that the molecules split into two atoms each having three translational motions. A further increase in heat capacity due to additional degrees of freedom for the microscopic motion becomes evident when the atoms begin to loose their electrons and the gas becomes a plasma of charged ions and free electrons.

We may understand the increase of heat capacity as due to the occurrence of new degrees of freedom, but once we have understood that molecules consist of atoms that consist of electrons and nuclei that consist of protons and neutrons that consist of — — we are faced with a big problem: These additional degrees of freedom exist all the time in the molecules. How come that we do not "feel" them at ordinary temperatures? How is it possible at all to speak of a well defined micro level of a macroscopic system when the parts themselves are wholes consisting of smaller parts that perhaps again may be subdivided in even smaller parts? It looks as if there is no "bottom" for the physical description but

rather an indefinitely descending hierarchy of microscopic levels. Where do we find the bedrock of microscopic dynamic from which the upward reaching causality extends to the macro-surface of thermodynamic systems?

This is one of the paradoxes that haunted classical physics around the turn of the century and led to the invention of quantum mechanics. The answer to the problem is that sub-microscopic degrees of freedom are "locked" by quantization of energy, and the smaller parts we consider the larger is the separation between their energy levels. When the level differences are much larger than the average energy of thermic motion it is impossible to transfer heat to these parts and therefore they do not contribute to the heat capacity. Therefore we are allowed to consider the gas at room temperature as a collection of classically moving rigid bodies for the purpose of dynamics, although we know full well that they consist of atoms, electrons and nucleons. The laws of quantum mechanics come into play for higher temperatures to describe the gradual loosening of the motions of these smaller particles and also for lower temperatures to describe the locking in of motions that are free at room temperature.

We see, thus, that the downward causative influence of the macroscopic boundary conditions on the microscopic dynamics is far more profound than just to delimit a certain part of the state space as available(see the paper by **Mark H. Bickhard**). The very notion of a microscopic state depends crucially on our ability to heat and isolate systems, and this ability is not reduceable to microscopic laws but depends on technology and intention. The physicists do not just isolate a natural system for closer study, but with their methods of preparation *create* the system, including the notion of microscopic parts and the laws that govern them.

The Nobel prize in physics for the year 1996 was given for the discovery of superfluidity of the Helium isotope ^3He .¹ However, this property only exist below a millidegree above the absolute zero of temperature, and, as the background temperature of the universe is between 2 and 3 degrees, more than a thousand times higher, we can be pretty sure, that superfluid ^3He only exists where there are physicists to study it.

2. Irreversibility and noise

All microscopic dynamical laws in physics are *reversible*, or *invariant under time reversal*. This means, that there is a certain mathematical operation that changes time t to $-t$ in connection with changes of other variables such that the same law applies to these transformed quantities. In classical mechanics we have to reverse all velocities when we reverse time. If we look at a motion picture of a lot of billiard balls in motion and compare a certain situation with the same situation in the same motion picture run backwards, then we see the same positions of the balls but the opposite velocities, but we cannot by watching of the two versions of the film decide which is run the wrong way, unless there is a situation that points to the setup or preparation of the scene. If, for example, we see ten balls lying still in a cluster and one rapid ball moving into the cluster scattering the others in all directions, then we would guess that we see the events in the correct order of time. The time reversed show of a lot of balls coming together in a multiple collision and transferring all their motion to a single ball would seem too improbable to be natural. We would know that no billiard player, however skillful, would be able to create such a sequence of events, except by sheer luck.

There is nothing in the laws of motion that forbid improbable occurrences, for the very notion of probability is totally alien to the laws, like the notions of skill and intention. When we introduce such considerations we are jumping from the microscopic, reversible world to the macroscopic world, where the laws are irreversible. A film showing an egg being dropped to the floor and splashed all over it displays this macroscopic type of behaviour, and nobody would be in doubt whether it is shown with the right or wrong direction of time.

Macroscopic irreversibility was first formulated in laws like Fourier's law of heat conduction and Ohm's law of electrical conduction. Later it was generalized by Clausius about 1860 in the law of the increasing *entropy*. This strange state function of thermodynamic systems has the peculiar property that it can only increase when it changes, and it does so whenever some *spontaneous* event takes place in an isolated system. We all know what such an event could be, e.g. self-ignition of burnable material, but the notion of *spontaneity* is just as alien to the microscopic dynamics as entropy and irreversibility.

In classical mechanics or quantum mechanics every change of the state of an isolated system is totally deterministic, being determined alone by the force-law and the present state. But in thermodynamics we cannot be sure that a quiet state

of equilibrium will remain so. It may be a metastable state, and a transition to a more favorable equilibrium (with higher entropy) may be triggered by unforeseeable fluctuations in an explosive way. There is a profound connection between irreversible behaviour and indeterminacy. If a system is able to reach a state of equilibrium in an irreversible way then there must be unpredictable fluctuations or *noise* in the system. Normally the noise will be sub-liminal, and it is neglected in laws like Fourier's and Ohm's. But there may occur situations where the future development may take several directions depending on marginal differences, and in such cases the presence of noise is crucial for the realization of macroscopic indeterminacy.

The intrinsic connection between irreversibility and noise is due to the statistical or probabilistic character of both.² This was illustrated with the example of the billiard balls, and in general we can use statistical models involving a moderately large number of particles to mediate between the seemingly irreconcilable paradigms of reversible micro-dynamics and irreversible thermodynamics.

The first attempt to reconcile these two physical disciplines was made by L. Boltzmann with the H-theorem from 1872. Boltzmann set up an equation to show how an arbitrary initial distribution of velocities of the molecules in a gas would be changed by collisions and finally stabilize itself in a statistical equilibrium. This was done by introduction of the H-functional that exhibited irreversible properties and could be used as a definition of entropy in statistical terms. Boltzmann was convinced of the correctness of thermodynamics, but his H-theorem was met with severe criticisms from mechanicians, Loschmidt, Zermelo, and Poincaré. The simplest objection was the *Umkehr-Einwand* by Loschmidt who simply pointed to the time-reversal symmetry of the mechanical laws and correctly concluded that no mechanical proof of the entropy law could be possible. The objection would not be so serious if it hadn't been put forward in a philosophical ground of mechanical reductionism. Everybody seemed to believe that Newton's laws of mechanics ought to explain everything, and the best arguments against this view and in support of Boltzmann were formulated by the physicist W. Gibbs and the philosopher C. S. Peirce, both in America far outside the European main stream of science at that time.³

In 1911, five years after the death of Boltzmann, Paul and Tatjana Ehrenfest published a thorough discussion of Boltzmann's theory and the objections against it.⁴ The *Umkehr-Einwand* was taken into consideration with a simple model of diffusion, that we shall briefly consider.

In the Ehrenfest diffusion model a collection of N numbered particles are distributed in two urns, or in the separate two halves of a container. Every second a number is chosen randomly between 1 and N , and the corresponding particle is transferred to opposite half-container. The figure below shows a simulation (or rather two simulations) with 200 particles (ragged curve). At time zero in the middle there are 180 particles in the right half of the container. Time proceeds from zero to 400 from the middle to the right boundary of the figure and from zero to -400 going to the left.

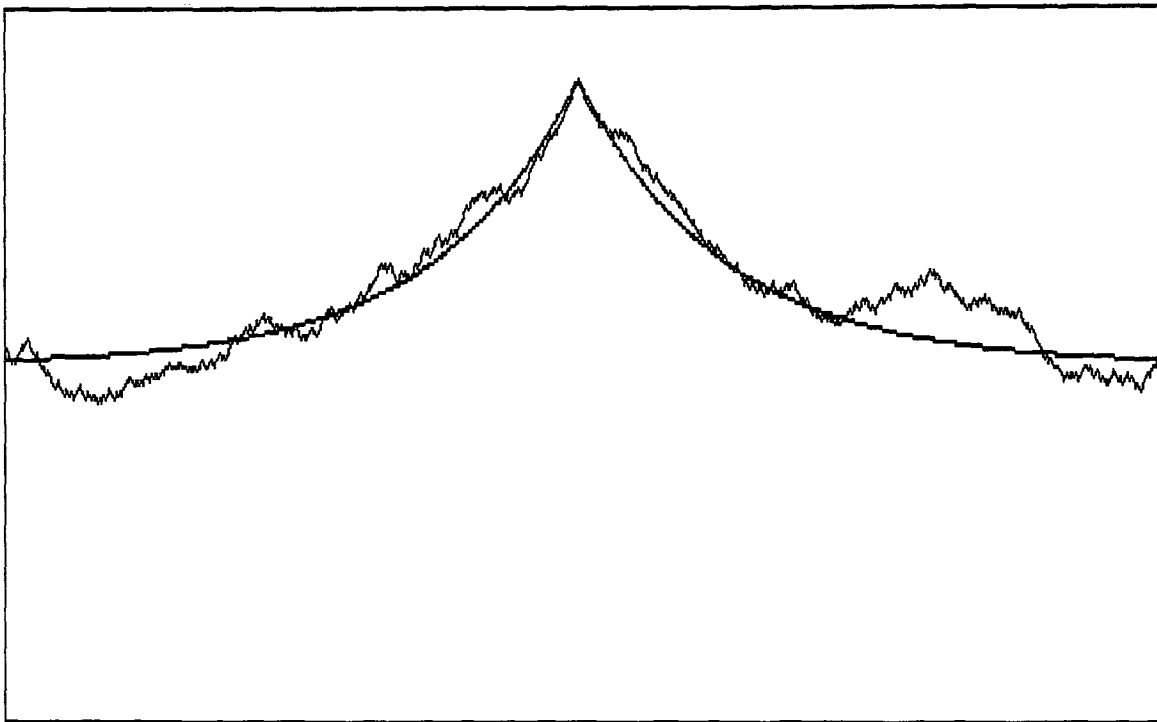

Figure 1 The Ehrenfest diffusion model. Vertical axis (0-200) shows the number of particles in the right half container. Horizontal axis: time from -400 to 400. Ragged curve: simulation. Smooth curve: average relaxation.

In this model time is just a counting number of a random draw and it makes no difference whether it is counted backwards or forwards. The leftward running simulation (0 to -400) of course looks slightly different from the rightward running (0 to 400) but that is just a statistical difference to be expected between two different simulations. The reversibility of the model is manifested by the approximate left-right symmetry of the figure

In principle we could regard the whole run as one single simulation from -400 to 400. The resulting curve is a *fractal* with small fluctuations within larger ones

and one especially large fluctuation right in the middle. It is not *impossible* that such a simulation result could occur but one gets suspicious that the large deviation in the middle is *prepared*, because the most probable distribution of particles is 100 in each half of the container and large deviations from that number are extremely rare. If a single simulation produced such a result we would be tempted to discard it because it is "untypical" just as if a shuffling of cards had produced a deck with all the diamonds in a single cluster with no other suits mixed in between. In fact, the probability of a random occurrence of 180 of the 200 particles in the right half-container is about 10^{-33} , so if we draw one number per second we would have to wait about $3 \cdot 10^{25}$ years before such a combination could be expected to occur once if there were no "cheating". Considering that the universe is only about 10^{10} years old we are almost allowed to say that such a large fluctuation is impossible.

Knowing, however, that the situation at time zero is *prepared* by the experimenter and that in reality there are two simulations, one counting forwards and one counting backwards in "time" there is nothing strange in the picture. If we make a lot of simulations from the same initial condition and calculate the average number of particles in the right container for each step of time the result is the smooth curves in figure 1 showing exponential relaxation of the initial large deviation in both directions of time. The reversibility of the model is *exact* for the two relaxation curves taken together, although the phenomenon of exponential relaxation in physics is always connected with irreversible phenomena. The *forward* relaxation curve looks exactly like the discharge of a capacitor through an ohmic resistance. Ohm's law alone will give the smooth exponential, and the deviations from it shown by the simulation correspond to the Nyqvist-Johnson noise from the resistor as filtered by the capacitor.

How can the reversible Ehrenfest model then account for the irreversibility described by Boltzmann? By showing that irreversibility is a result of the experimenter's ability to prepare an improbable initial state and letting the dynamical situation proceed *forwards* in time. It is only the right half of figure 1 that can be regarded as a physical model of diffusion. The experimenter can have the 180 particles put into the right half of the container at time zero and then let the system run its course by itself, but he cannot choose an initial state like the one at time -400 that will evolve by itself to the very improbable state at time zero. If the experimenter had a "memory of the future" he could perhaps do the trick, but he only knows the past and he therefore cannot select among all the many similarly looking states near equilibrium one of the few initial states that will develop into a conspicuously deviating state.

The question of how irreversibility arises is thus transferred from the domain of microscopic dynamics to the irreversible behaviour of the experimenter. How can it be that we only have a memory of the past and that our sense of time always proceeds in the same direction? This question cannot be answered reductionistically by considering a human being like a collection of molecules that act together according to the laws of mechanics, for, as we have seen, these laws are all reversible and have no sense of "time's arrow". But the human body works as it should only if it is inserted in an ecological system with available food and clean air and water, a thermodynamic system far from equilibrium. Such a system has a tendency to relax towards equilibrium producing entropy and it is this tendency that nourishes the organism and provides it with a sense of time. If the ecological system were isolated in the universe it would run down to equilibrium and the organisms would die. But it is maintained in the non-equilibrium state by a flow of low-entropic energy from the sun that can be converted into high-entropy heat radiation and scattered out into the background radiation of the universe. The question of the origin of irreversibility is thus pushed upwards as far as "up" goes in physics: to the irreversible evolution of the whole universe.

The recognition of this multi-level downward causation from the ecosystem through the experimenter's ability to select improbable initial states for a thermodynamic system changes the status of the sentence "the entropy increases" from a paradox to a tautology. For the prerequisite of being able to say anything is that the entropy of the universe is higher after the saying than it was before. The same entropic condition applies to any significant event, to every difference that makes a difference, i.e. rises appreciably above the noise level of fluctuations.

3. The emergence of boundaries

In the early universe matter is uniformly distributed in a gaseous state of internal thermodynamic equilibrium. In such a state there are no boundaries, it is impossible to separate a system from its surroundings, and no signs or significant actual events can exist. Nothing marks the space, and gravitation is cancelling itself out. However, the increasing scale or expansion sets up an external control parameter that gradually forces internal symmetry breaking choices that set up ordering fields acting as internal control parameters for the creation of significant

boundaries, limitations, and constraints. These constraints, in turn, lead to greater *semiotic freedom*, or *liberation of the semiosphere*, as pointed out by Jesper Hoffmeyer⁵

A specific type of order, created by spontaneous symmetry-breaking may generalize itself by the action of the ordering field it makes. For example, a larger concentration of matter in a volume creates a gravitational attraction towards its center such that surrounding material gets sucked in making the gravitational pull even stronger. The resulting local inhomogeneity of matter creates a spreading tendency to form nucleation centers for matter in space. Gravitation, previously lying dormant, in this way becomes generalized to a habit of the universe, becomes *significant*.

According to Peirce this is *semiosis* at work. A slumbering affinity or similarity is an *icon*, an actual difference is an *index*, and a habit or general rule is a *symbol*. Symbols are general ideas that spread and loose intensity but become associated with other ideas whereby new symbols are created. This is Peirce's *law of mind*.

The phenomenology and metaphysics of C. S. Peirce distinguishes between three ontological modes or categories:

1. **Firstness:** This is the mode of *potentiality* and *being*.
2. **Secondness:** *Actuality* and *individual existence*.
3. **Thirdness:** *Generality* and *reality*.

The categories follow each other such that Secondness presupposes and contains Firstness, and Thirdness presupposes and contains Firstness and Secondness.

The emergence of a boundary separating between spatially extended qualities is a Secondness arising as an actual distinction between Firstnesses. If we think of something like a water surface we can imagine how the constrained space of the surface evolves it own laws by downward causation, and indexical signs like drops of water become generalized and symbolized to rain and rivers and oceans (with birds, boats, and fishes).

Internally there is no qualitative difference between a gas and a liquid. There is no long range order and the molecules wander erratically around. So, if it is at all possible to distinguish between gas and liquid it must be due to the existense

of a surface that separates the denser liquid from the rarefied gas. Secondness enters the picture through the surface that distinguishes between the internal Firstnesses of the two phases, but while the gaseous phase keeps its unconstrained Firstness, the liquid is contaminated with Secondness, for the surface belongs to the liquid it confines. The surface introduces a *tension* that keeps drops of liquid together.

The qualitative features of the gas-liquid transition was first described mathematically with the Van der Waals equation of state (1872). This equation explains the existence of a *critical point* (P_c, T_c) in the pressure-temperature plane such that the distinction between gas and liquid only exists for certain pressures when the temperature is below the critical temperature T_c . Van der Waals' equation (see appendix) has become paradigmatic, not because of its quantitative agreement with measurements for real gases (which is not impressive) but because it gives a simple conceptual scheme for the discussion of *order-disorder transitions* (or second order phase transitions). The hypostatic abstraction of this concept was perfected by L. D. Landau in the *mean field theory of second order phase transitions*^{*)} (1950)⁶ and by R. Thom in the so-called *catastrophe-theory* (1978).⁷ The gas-liquid transition exemplifies the *cuspid-catastrophe* of Thom, and this is the simplest model for describing how a type of order nucleates spontaneously and is able to induce similar ordering in its surroundings. By means of Van der Waals' equation one is able to formulate a law of *corresponding states* for different gases. For example, the *reduced pressure* P/P_c of saturated vapour is a universal function of the *reduced temperature* T/T_c as shown in figure 2

^{*)} Other examples of such transitions are the ferromagnetic and the superconductive transitions, and order-disorder transitions in alloys.

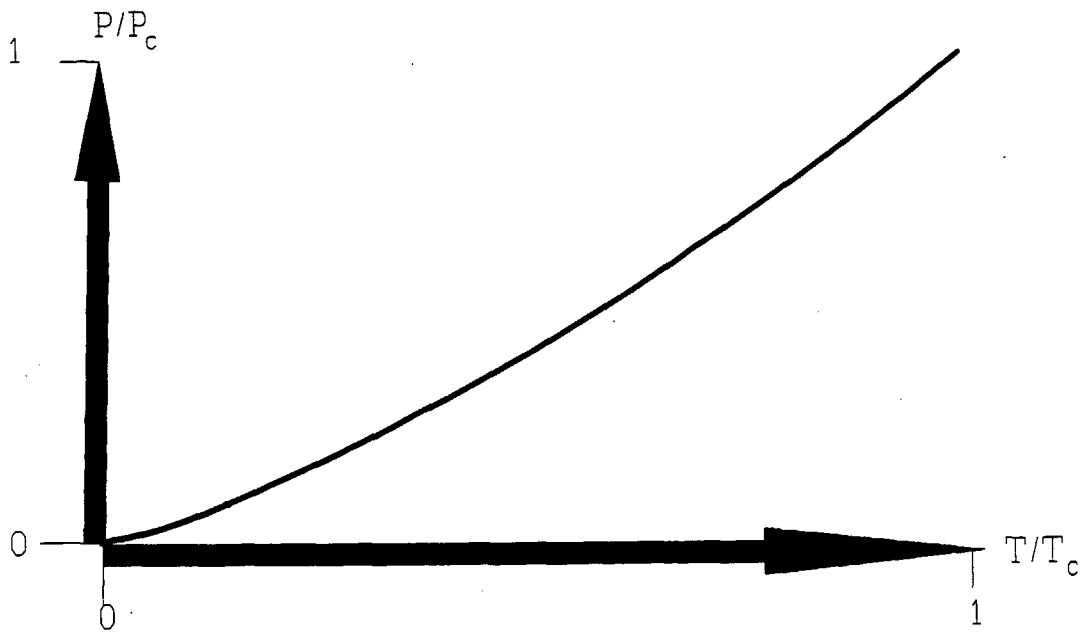

Figure 2 Reduced pressure of saturated vapour as function of reduced temperature according to van der Waals.

As shown in figure 3 the cusp catastrophe requires two control parameters, a and b , where a is the "external" control (temperature) and b the "internal" control (ordering field). For the case of the gas-liquid transition b is roughly proportional to the deviation of the pressure from the critical pressure. (see, however, the discussion of the control-parameters in the appendix).

The a - and b -axes in figure 2 are made to cross in the critical point. Above this point (for higher values of a) no ordering is possible (no surface), but below there is an interval of b values where the two phases may coexist.

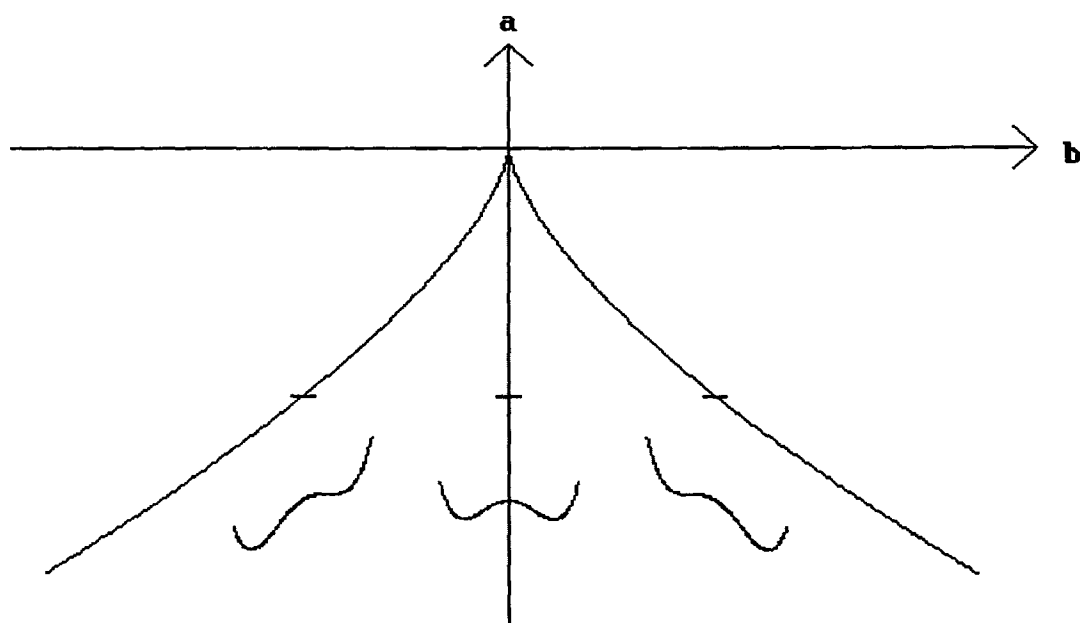

Figure 3 The cusp catastrophe. Potential as function of order parameter shown for marked points below the cusp.

The ordered phase is described by an *order parameter* which for the gas-liquid transition is the difference in density between the two phases separated by the surface. The equilibrium value of the order parameter is one that minimizes the thermodynamic potential (Gibbs' free energy). The *catastrophe set* in the control plane is a curve that exhibits a cusp in the critical point. This curve separates a

region where this potential has two minima below the cusp from another region where it has only one minimum.

The left minimum corresponds to the gaseous phase and the right to the liquid phase. Close to the critical point, where the saturated vapour pressure is equal to the critical pressure, the two phases may coexist in equilibrium only on the line $b=0$. Normally in thermodynamics one assumes that the lowest minimum is the stable one, such that the two phases may coexist only when the two minima have the same height, i.e. on the a -axis below the cusp. This assumption corresponds to the so called Maxwell convention. In reality, however, there may be a region with "superheated liquid" to the left of the a -axis and a region with "supercooled vapour" to the right and these regions of metastability may extend to the catastrophe curve, but not beyond, which is the convention of "maximum delay". Where the transition actually takes place is determined, among other things, by characteristics of the surface. Very small bubbles of liquid have a high surface tension which increases the internal pressure such that the bubble may be superheated.

The emergence of the phase separating boundary to a liquid phase in a gaseous region is a complicated cooperative phenomenon. A mist of small droplets appears, and gradually these droplets coalesce whereby the pressure is regulated through the action of surface tension (and perhaps gravitation). When the external control parameter is lowered (a , the temperature) large density fluctuations will begin to appear, and these will adjust the internal control (b , the pressure deviation) so as to pass through the critical point. Below criticality the fusion of droplets will tend to keep the system in the close neighbourhood of the a -axis, $b = 0$, the line of saturated vapour pressure.

The emergence of boundaries like the liquid surface is the first step in the *semiosis* of natural pre-biological evolution. It is the transition from the slumbering Firstness of icons to the specificity and actuality of indices. But the law of mind comes to play by the downward causative influence of habit formation. A habit is an emerging generality, a Peircean Thirdness that presupposes the significant difference of Secondness. An occurrence governed by habit is facilitated by its own previous occurrence. In this way the habit implies a self-reference that makes it a suitable third factor or *interpretant* of a symbolic sign relation.

We have seen that the surface tension is a feature that arises by downward causality. But liquid surfaces and other types of emergent boundaries tend to develop specific habits that do not belong to the world of microscopic dynamics.

The significance of singular shapes in the control space, like the cusp and the line of coexistence in figure 2 is due to a tendency of boundaries to proliferate themselves, and this is done most efficiently in the neighbourhood of critical regions. The phenomenon of *self organized criticality* (SOC) that has been described by Per Bak *et al* ⁸ seems to be a most important fact for the understanding of semiosis in evolution. The simplest example is that of the sand dune that maintains a critical slope because just this slope has the maximal ability to respond by avalanches of all sizes to every disturbance.

Phase separating boundaries create a confined space for special types of disturbances, like ripples on the water. These modes have a dominating downward causative influence near the critical point, as described in the *slaving principle* by H. Haken:

"Haken's slaving principle states that in the neighborhood of critical points, the behavior of a complex system is completely governed by few collective modes, the order parameters, that slave all the other modes."⁹

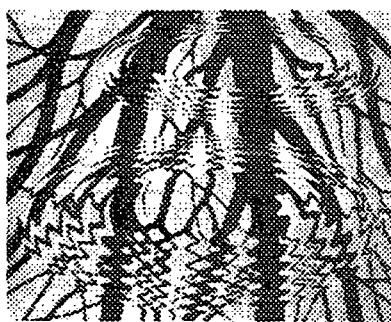

Figure 4 rippled surface
by M.C. Escher. Lino-cut
1950

These surface modes have dynamic properties determined by overall metrical properties of the surface, like its fractal dimension. On the other hand, these modes have the function of maintaining the overall characteristics of the surface that maximizes the diversity of internal motion which is close to the critical region of marginal instability. The working of the pre-biotic *law of mind* may thus be described as a complex interplay of upwards and downwards causality.

4. Notes and references

1. The Nobel laureates (physics, 1996) D.M. Lee, R.C. Richardson, and D.D. Osheroff discovered the superfluidity of ^3He in 1971.
2. The most general formulation of this connection is the *fluctuation-dissipation theorem* of Callen and Welton (1951).
3. J. W. Gibbs and C. S. Peirce were both born in 1839 and both graduated in chemistry and had some correspondence with each other. Gibbs developed his *Statistical Mechanics* about the same time as Boltzmann. Peirce wrote about the philosophical aspects of chance and necessity (*The Doctrine of Necessity Examined*, 1892), defended Boltzmann's views against mechanists and pointed to the need for a new mechanical theory of atoms.
4. P. and T. Ehrenfest. *The Conceptual Foundations of the Statistical Approach in Mechanics*, Dover Publications New York, 1990. (original article in german published in the *Encyclopädie der Mathematischen Wissenschaften*, 1911).
5. Jesper Hoffmeyer (1996): *Signs of Meaning in the Universe*, Indiana University Press.
6. L. D. Landau and E. M. Lifshitz, *Statistical Physics*, Pergamon Press, London, 1959.
7. T. Poston and I. Stewart, *Catastrophe Theory and its Applications*, Pitman, London 1978.
The name *Catastrophe Theory* was invented by E. C. Zeeman (1972) to denote Thom's theory of differential topology, outlined in the book R. Thom, *Stabilité structurelle et morphogenese. Essai d'une theorie general des modeles*, Benjamin, Reading, 1972.
8. P. Bak, C. Tang, and K. Wiesenfeld, *Self-organized Criticality*, Phys. Rev. A 38, 364, (1988).
9. Scott Kelso, (1995): "Dynamic Patterns", (M.I.T.).

Appendix: van der Waals' equation of state

1. Virials and Van der Waals .

In the article "Man's Glassy Essence"^{*)} Peirce attempted to put up a materialistic theory for the metabolism and self-reproduction of living cells. The physical foundation for this theory was the virial theorem and van der Waals' equation of state. Even though Peirce's article takes an idealistic turn towards the end it is still important as an expression for Peirce's *semiotic realism*, and— as the theory also in the present article is basic for the discussion of emergence of surfaces, we shall briefly consider it in this appendix.

In classical statistical mechanics the so-called *law of equipartition* states that the average *kinetic energy* per. degree of freedom is $\frac{1}{2}kT$. In contradistinction, the average *potential energy* is not so easy to calculate. Instead we can express the deviation from ideality of gases by the *virial*, that is the average sum of attractive force times distance, that affects one molecule from all the others. *The Virial theorem* of Clausius can be stated in the form^{**)}

$$kT = Pv + \frac{1}{3} \cdot \sum \bar{Fr} \quad (1)$$

where P is the pressure and v the volume per. molecule, i.e. the total volume V divided the number of molecules. The last term is the molecular virial. Here, the situation is viewed from the place of one, arbitrarily chosen, molecule, and we sum for all other molecules the *attractive force* F (i.e. -F, if the force is repulsive) times the distance r from the chosen molecule. Finally, this quantity is averaged over all molecules (denoted by the bar over Fr). If we can disregard the interaction between molecules, the virial disappears, and equation (1) degenerates to the state equation of ideal gases.

^{*)} **The Monist**, vol. III, 1892.
 (oversat til dansk og forsynet med indledning og noter
 af forfatteren (PVC) i bogen
 Charles Sanders Peirce: Kosmologi og metafysik,
 Gyldendal, Moderne tænkere, 1996).

^{**)} See e.g. D.Ter Haar: *Elements of Statistical Mechanics*.
 Holt, Rinehart, and Winston (1954)

We may get a simple expression for the v -dependence of the virial if we assume that the molecules are uniformly distributed in space. If we place a sphere of radius R and center in a molecule, then the number of other molecules in this sphere will be the sphere's volume divided by v . We shall further assume that the attraction F decreases with distance faster than r^{-3} *). We can then choose R sufficiently big, so that the molecules outside the sphere don't significantly contribute to the virial. It then follows that the virial must be proportional to the number of molecules in the sphere. i.e. inversely proportional to v . Equation (1) can, therefore, be written in the form

$$kT = Pv + \frac{a}{v} = \left(P + \frac{a}{v^2}\right) \cdot v \quad (2)$$

where we have included the factor $1/3$ from eq. (1) in the constant a . The introduction of this constant instead of the individual virials makes the following theory belong to the family of *mean field theories* of second order phase transitions that is comprised by Thom's cusp-catastrophe.

In this model we have disregarded the repulsive core of the intermolecular forces, but we can take it into account, roughly, by ascribing to each molecule a proper volume b . In van der Waals' equation (2) this is done by replacing v with "the free volume" $v-b$. If, simultaneously, we introduce *molar* quantities in stead of *molecular* Eq (2) is changed to the traditional form of van der Waals' equation:

$$\left(P + \frac{a}{v^2}\right) \cdot (v - b) = RT \quad (3)$$

where R is the gas-constant, i.e. Boltzmann's constant k times Avogadro's number. In the general thermodynamics of real gases one assumes that the virial can be series-expanded in the quantity $1/v$. The term a/v in eq. (2) is the first term in *the virial expansion*:

$$Pv = RT \cdot [1 + a_1(T) \cdot v^{-1} + a_2(T) \cdot v^{-2} + \dots] \quad (4)$$

For van der Waals' equation (3) we have:

*) The attractive tail of the van der Waals-forces, due to mutually induced molecular dipoles goes as r^{-6} .

$$P = \frac{RT}{v-b} - \frac{a}{v^2} \quad (5)$$

by series expansion of the first term on the left side of (5) and comparison with (4) we then find, that the first two of the virial coefficients according to van der Waals are given by:

$$a_1 = b - \frac{a}{RT} ; a_2 = b^2 \quad (6)$$

Specifically, that the second virial coefficient is temperature-independent

2. Reduced variables and corresponding states.

Van der Waals' equation (2) can be written as a cubic equation in v :

$$Pv^3 - (Pb + RT)v^2 + av - ab = 0 \quad (7)$$

One finds, that there is a critical temperature T_c , such that there for $T < T_c$ exists a P -interval with three solutions for v . For $T > T_c$ there will for each value of P only be one value of v , that satisfies eq. (7). For $T = T_c$ there will be one point, $P = P_c$, $v = v_c$, where the polynomial $Q(v)$ on the left side of (7) is zero, while, simultaneously, both its first and its second derivative vanish. In order to determine the critical values v_c , P_c , and T_c we have to solve (7) together with the equations:

$$Q'(v) = 3Pv^2 - 2(Pb + RT)v + a = 0 \quad (8)$$

$$Q''(v) = 6Pv - 2(Pb + RT) = 0 \quad (9)$$

By the solution, e.g. one may first find from (9), that

$$Pb + RT = 3Pv \quad (9a)$$

This is then inserted in (8) and one gets:

$$v^2 = \frac{a}{3P} \quad (8a)$$

By insertion of (9a) og (8a) i (7) we find:

$$0 = v[Pv^2 - (P+RT)v + a] - ab = v[-2Pv^2 + a] - ab = a(v/3 - b).$$

Det critical volume is thus

$$v_c = 3b \quad (10)$$

og by insertion of this value in (8a) og (9a) we find:

$$P_c = \frac{a}{27b^2} \quad (11)$$

$$T_c = \frac{8a}{27bR} \quad (12)$$

we may then introduce dimensions-less, or reduced variables, viz. the reduced volume v , the reduced pressure π , and the reduced temperature τ by the definitions:

$$v = v \cdot v_c ; P = \pi \cdot P_c ; T = \tau \cdot T_c \quad (13)$$

Inserting these expressions in van der Waals' equation (3), it attains the dimension-less form:

$$\left(\pi + \frac{3}{v^2}\right) \cdot (3v - 1) = 8\tau \quad (14)$$

In this way every reference to the specific properties of the gases vanishes. We say that two gases with the same samme values of the reduced variables are in *corresponding states*.

3. the pressure of saturated vapour.

We start by writing (14) as a cubic equation in v :

$$v^3 + Av^2 + Bv + C = 0$$

$$A = -\frac{1}{3}\left(1 + \frac{8\tau}{\pi}\right); B = \frac{3}{\pi}; C = -\frac{1}{\pi} \quad (15)$$

Even though it is easy to determine the isotherms π as function of v for fixed τ by using af (14):

$$\pi = \frac{8\tau}{3v-1} - \frac{3}{v^2} \quad (16)$$

it may in some situation be necessary to go the other way and find v as a function of π (for fixed τ) by solving the cubic equation (15).

For $\tau < 1$ there exists a π -interval, where (15) has three solutions for v . By placing a line of constant π in this interval, the areas between the isothermal-curve and the line be found analytically by integration of (16), when the points of intersection have been found by solving (15). The pressure of saturated vapour is then, according to Maxwell, that value of π , that makes the areas over and below the line of equal size. (see figure A2). This so-called Maxwell-convention corresponds to the thermodynamic condition of equilibrium that the chemical potentials of the two phases shall be equal. The isotherm can, according to (16) have negative values of π for $\tau < 27/32$, men that doesn't matter, because the part of the isotherms, that lies under the Maxwell-line, is unphysical, anyway. The following table and curve (figure A1) shows the results for the pressure of saturated vapours reducerede tryk as function of the reduced temperature, determined by numerical solution of the Maxwell-condition.

τ	π
0.96	0.8476
0.9	0.6470
0.8	0.3834
0.7	0.2005
0.6	0.0869
0.5	0.0278

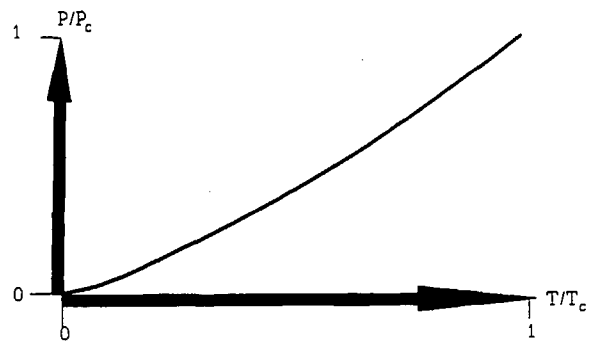

Figure A1. Qualitative sketch of the reduced pressure of saturated vapour as a function of reduced temperature.

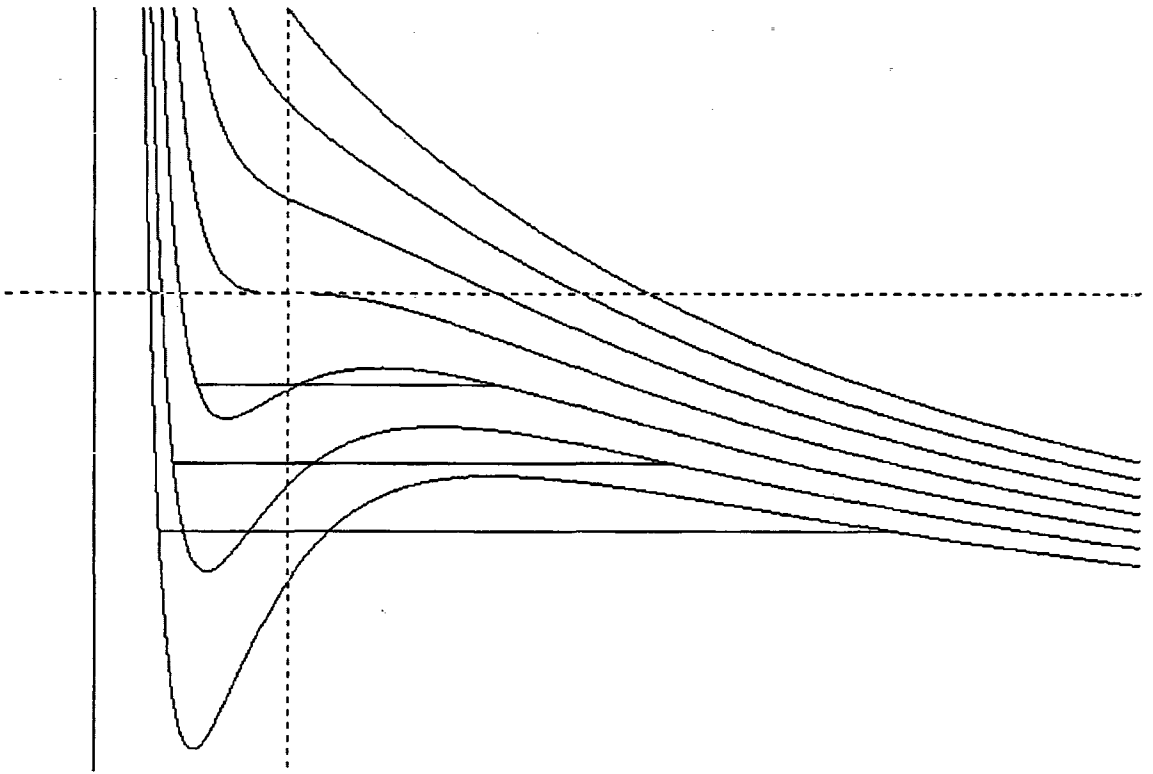

Figure A2. van der Waals isotherms and Maxwell-lines : v as a function of π for fixed τ . The critical isotherm ($\tau=1$) has a horizontal tangent of inflection at the critical pressure.

4 .

4. Cusp and control-parameters.

In the general theory of cubic equations in the form (15) one introduces the *mathematical control-parameters*

$$\alpha = B - \left(\frac{A}{3}\right)^3$$

$$\beta = -\left(\frac{A}{3}\right)^3 + \frac{AB}{6} - \frac{C}{2}$$

corresponding to the parameters a and b in figure 3, respectively

The number of solutions to the equation is then determined by the sign of the expression

$$D = b^2 - a^3$$

$$\tau = 1 + \delta\tau; \pi = 1 + \delta\pi$$

$\delta\tau$ and $\delta\pi$ are then related to α and β by a linear transformation, and for both sets of control-parameters the critical point (the cusp) is located in (0,0). In catastrophe theory it is assumed (based on results by Morse and Thom) that such a transformation leaves the topology of the singularity unchanged, but exactly how the system passes through the critical point depends on the physical mechanism of self-organized-criticality (SOC) that acts by means of the critical density fluctuations and the slaving surface modes, and the mean field theories, like Thom's cusp does not take these fluctuations into account. It has been shown that the mean field description is strictly valid, only in a four-dimensional euclidean space. In all other cases the theory has to be *renormalized*, and the exact behavior of the renormalized cusp has not been fully determined, not even for such qualitative features as the *critical exponents* of the power laws that govern the SOC. The "slaving" surface modes that govern the SOC may lead the physical control-parameters to the critical point by some power law, so that even the cusp-shape ($a = -b^{2/3}$) of the mathematical catastrophe set may need renormalization.

Still, the cusp catastrophe and the mean field theory of phase transitions has its paradigmatic merits as the simplest description of a second order phase transition with a critical point.

227/92 "Computersimulering og fysik"
af: Per M.Hansen, Steffen Holm,
Peter Maibom, Mads K. Dall Petersen,
Pernille Postgaard, Thomas B.Schröder,
Ivar P. Zeck
Vejleder: Peder Voetmann Christiansen

Liste over tidligere udkomne tekster
tilsendes gerne. Henvendelse herom kan
ske til IMFUFA's sekretariat

tlf. 46 74 22 63

228/92 "Teknologi og historie"
Fire artikler af:
Mogens Niss, Jens Høyrup, Ib Thiersen,
Hans Hedal

229/92 "Masser af information uden betydning"
En diskussion af informationsteorien
i Tor Nørretranders' "Mærk Verden" og
en skitse til et alternativ baseret
på andenordens kybernetik og semiotik.
af: Søren Brier

217/92 "Two papers on APPLICATIONS AND MODELLING
IN THE MATHEMATICS CURRICULUM"
by: Mogens Niss

230/92 "Vinklens tredeling - et klassisk
problem"
et matematisk projekt af
Karen Birkelund, Bjørn Christensen
Vejleder: Johnny Ottesen

218/92 "A Three-Square Theorem"
by: Lars Kadison

219/92 "RUPNOK - stationær strømning i elastiske rør"
af: Anja Boisen, Karen Birkelund, Mette Olufsen
Vejleder: Jesper Larsen

231A/92 "Elektrondiffusion i silicium - en
matematisk model"
af: Jesper Voetmann, Karen Birkelund,
Mette Olufsen, Ole Møller Nielsen
Vejledere: Johnny Ottesen, H.B.Hansen

220/92 "Automatisk diagnosticering i digitale kredsløb"
af: Bjørn Christensen, Ole Møller Nielsen
Vejleder: Stig Andur Pedersen

231B/92 "Elektrondiffusion i silicium - en
matematisk model" Kildetekster
af: Jesper Voetmann, Karen Birkelund,
Mette Olufsen, Ole Møller Nielsen
Vejledere: Johnny Ottesen, H.B.Hansen

221/92 "A BUNDLE VALUED RADON TRANSFORM, WITH
APPLICATIONS TO INVARIANT WAVE EQUATIONS"
by: Thomas P. Branson, Gestur Olafsson and
Henrik Schlichtkrull

222/92 On the Representations of some Infinite Dimensional
Groups and Algebras Related to Quantum Physics
by: Johnny T. Ottesen

232/92 "Undersøgelse om den simultane opdagelse
af energiens bevarelse og isærdeles om
de af Mayer, Colding, Joule og Helmholtz
udførte arbejder"
af: L.Arleth, G.I.Dybkjær, M.T.Østergård
Vejleder: Dorthe Posselt

223/92 THE FUNCTIONAL DETERMINANT
by: Thomas P. Branson

233/92 "The effect of age-dependent host
mortality on the dynamics of an endemic
disease and
Instability in an SIR-model with age-
dependent susceptibility
by: Viggo Andreasen

224/92 UNIVERSAL AC CONDUCTIVITY OF NON-METALLIC SOLIDS AT
LOW TEMPERATURES
by: Jeppe C. Dyre

234/92 "THE FUNCTIONAL DETERMINANT OF A FOUR-DIMENSIONAL
BOUNDARY VALUE PROBLEM"
by: Thomas P. Branson and Peter B. Gilkey

225/92 "RATMODELLEN" Impedansspektroskopi i ultrarent
en-krystallinsk silicium
af: Anja Boisen, Anders Gorm Larsen, Jesper Varmer,
Johannes K. Nielsen, Kit R. Hansen, Peter Bøggild
og Thomas Hougaard
Vejleder: Petr Viscor

235/92 OVERFLADESTRUKTUR OG POREUDVIKLING AF KOKS
- Modul 3 fysik projekt -
af: Thomas Jessen

226/92 "METHODS AND MODELS FOR ESTIMATING THE GLOBAL
CIRCULATION OF SELECTED EMISSIONS FROM ENERGY
CONVERSION"
by: Bent Sørensen

- 236a/93 INTRODUKTION TIL KVANTE HALL EFFEKTEN
af: Anja Boisen, Peter Bøggild
Vejleder: Peder Voetmann Christiansen
Erland Brun Hansen
- 236b/93 STRØMSSAMMENBRUD AF KVANTE HALL EFFEKTEN
af: Anja Boisen, Peter Bøggild
Vejleder: Peder Voetmann Christiansen
Erland Brun Hansen
- 237/93 The Wedderburn principal theorem and Shukla cohomology
af: Lars Kadison
- 238/93 SEMIOTIK OG SYSTEMEGENSKABER (2)
Vektorbånd og tensorer
af: Peder Voetmann Christiansen
- 239/93 Valgsystemer - Modelbygning og analyse
Matematik 2. modul
af: Charlotte Gjerrild, Jane Hansen, Maria Hermansson, Allan Jørgensen, Ragna Clauson-Kaas, Poul Lützen
Vejleder: Mogens Niss
- 240/93 Patologiske eksempler.
Om sære matematiske fisks betydning for den matematiske udvikling
af: Claus Dråby, Jørn Skov Hansen, Runa Ulsoe Johansen, Peter Meibom, Johannes Kristoffer Nielsen
Vejleder: Mogens Niss
- 241/93 FOTOVOLTAISK STATUSNOTAT 1
af: Bent Sørensen
- 242/93 Brovedligeholdelse - bevar mig vel
Analyse af Vejdirektoratets model for optimering af broreparationer
af: Linda Kyndlev, Kare Fundal, Kamma Tulinius, Ivar Zeck
Vejleder: Jesper Larsen
- 243/93 TANKEEKSPERIMENTER I FYSIKKEN
Et 1.modul fysikprojekt
af: Karen Birkelund, Stine Sofia Korremann
Vejleder: Dorthe Posselt
- 244/93 RADONTRANSFORMATIONEN og dens anvendelse i CT-scanning
Projektrapport
af: Trine Andreasen, Tine Guldager Christiansen, Nina Skov Hansen og Christine Iversen
Vejledere: Gestur Olafsson og Jesper Larsen
- 245a+b /93 Time-Of-Flight målinger på krystallinske halvledere
Specialerapport
af: Linda Szkotak Jensen og Lise Odgaard Gade
Vejledere: Petr Viscor og Niels Boye Olsen
- 246/93 HVERDAGSVIDEN OG MATEMATIK - LÆREPROCESSER I SKOLEN
af: Lena Lindenskov, Statens Humanistiske Forskningsråd, RUC, IMFUFA
- 247/93 UNIVERSAL LOW TEMPERATURE AC CONDUCTIVITY OF MACROSCOPICALLY DISORDERED NON-METALS
by: Jeppe C. Dyre
- 248/93 DIRAC OPERATORS AND MANIFOLDS WITH BOUNDARY
by: B. Booss-Bavnbek, K.P.Wojciechowski
- 249/93 Perspectives on Teichmüller and the Jahresbericht Addendum to Schappacher, Scholz, et al.
by: B. Booss-Bavnbek
With comments by W.Abikoff, L.Ahlfors, J.Cerf, P.J.Davis, W.Fuchs, F.P.Gardiner, J.Jost, J.-P.Kahane, R.Lohan, L.Lorch, J.Radkau and T.Söderqvist
- 250/93 EULER OG BOLZANO - MATEMATISK ANALYSE SET I ET VIDENSKABSTEORETISK PERSPEKTIV
Projektrapport af: Anja Juul, Lone Michelsen, Tomas Højgård Jensen
Vejleder: Stig Andur Pedersen
- 251/93 Genotypic Proportions in Hybrid Zones
by: Freddy Bugge Christiansen, Viggo Andreassen and Ebbe Thue Poulsen
- 252/93 MODELLERING AF TILFELDIGE FÆNOMENER
Projektrapport af: Birthe Friis, Lisbeth Helmggaard Kristina Charlotte Jakobsen, Marina Mosbek Johannessen, Lotte Ludvigsen, Mette Hass Nielsen
- 253/93 Kuglepakning
Teori og model
af: Lise Arleth, Kare Fundal, Nils Kruse
Vejleder: Mogens Niss
- 254/93 Regressionsanalyse
Materiale til et statistikkursus
af: Jørgen Larsen
- 255/93 TID & BETINGET UAFHÆNGIGHED
af: Peter Harremoës
- 256/93 Determination of the Frequency Dependent Bulk Modulus of Liquids Using a Piezoelectric Spherical Shell (Preprint)
by: T. Christensen and N.B.Olsen
- 257/93 Modellering af dispersion i piezoelektriske keramikker
af: Pernille Postgaard, Jannik Rasmussen, Christina Specht, Mikko Østergård
Vejleder: Tage Christensen
- 258/93 Supplerende kursusmateriale til "Lineære strukturer fra algebra og analyse"
af: Mogens Brun Reefelt
- 259/93 STUDIES OF AC HOPPING CONDUCTION AT LOW TEMPERATURES
by: Jeppe C. Dyre
- 260/93 PARTITIONED MANIFOLDS AND INVARIANTS IN DIMENSIONS 2, 3, AND 4
by: B. Booss-Bavnbek, K.P.Wojciechowski

- 261/93 OPGAVESAMLING
Bredde-kursus i Fysik
Eksamensopgaver fra 1976-93
- 262/93 Separability and the Jones Polynomial
by: Lars Kadison
- 263/93 Supplerende kursusmateriale til "Lineære strukturer fra algebra og analyse" II
af: Mogens Brun Heefelt
- 264/93 FOTOVOLTAISK STATUSNOTAT 2
af: Bent Sørensen
-
- 265/94 SPHERICAL FUNCTIONS ON ORDERED SYMMETRIC SPACES
To Sigurdur Helgason on his sixtyfifth birthday
by: Jacques Faraut, Joachim Hilgert and Gestur Olafsson
- 266/94 Kommensurabilitets-oscillationer i laterale supergitre
Fysikspeciale af: Anja Boisen, Peter Bøggild, Karen Birkelund
Vejledere: Rafael Taboryski, Poul Erik Lindelof, Peder Voetmann Christiansen
- 267/94 Kom til kort med matematik på Eksperimentarium - Et forslag til en opstilling
af: Charlotte Gjerrild, Jane Hansen
Vejleder: Bernhelm Booss-Bavnbek
- 268/94 Life is like a sewer ...
Et projekt om modellering af aorta via en model for strømning i kloakrør
af: Anders Marcussen, Anne C. Nilsson, Lone Michelsen, Per M. Hansen
Vejleder: Jesper Larsen
- 269/94 Dimensionsanalyse en introduktion metaprojekt, fysik
af: Tine Guldager Christiansen, Ken Andersen, Nikolaj Hermann, Jannik Rasmussen
Vejleder: Jens Højgaard Jensen
- 270/94 THE IMAGE OF THE ENVELOPING ALGEBRA AND IRREDUCIBILITY OF INDUCED REPRESENTATIONS OF EXPONENTIAL LIE GROUPS
by: Jacob Jacobsen
- 271/94 Matematikken i Fysikken.
Opdaget eller opfundet NAT-BAS-projekt
vejleder: Jens Højgaard Jensen
- 272/94 Tradition og fornyelse
Det praktiske elevarbejde i gymnasiets fysikundervisning, 1907-1988
af: Kristian Hoppe og Jeppe Guldager
Vejledning: Karin Beyer og Nils Hybel
- 273/94 Model for kort- og mellemdistanceløb
Verifikation af model
af: Lise Fabricius Christensen, Helle Pilemann, Bettina Sørensen
Vejleder: Mette Olufsen
- 274/94 MODEL 10 - en matematisk model af intravenøse anæstetikas farmakokinetik
3. modul matematik, forår 1994
af: Trine Andreassen, Bjørn Christensen, Christine Green, Anja Skjoldborg Hansen, Lisbeth Helmgård
Vejledere: Viggo Andreassen & Jesper Larsen
- 275/94 Perspectives on Teichmüller and the Jahresbericht 2nd Edition
by: Bernhelm Booss-Bavnbek
- 276/94 Dispersionsmodellering
Projektrapport 1. modul
af: Gitte Andersen, Rehannah Borup, Lisbeth Friis, Per Gregersen, Kristina Vejre
Vejleder: Bernhelm Booss-Bavnbek
- 277/94 PROJEKTARBEJDSPÆDAGOGIK - Om tre tolkninger af problemorienteret projektarbejde
af: Claus Flensted Behrens, Frederik Voetmann Christiansen, Jørn Skov Hansen, Thomas Thingstrup
Vejleder: Jens Højgaard Jensen
- 278/94 The Models Underlying the Anaesthesia Simulator Sophus
by: Mette Olufsen(Math-Tech), Finn Nielsen (RISØ National Laboratory), Per Føge Jensen (Herlev University Hospital), Stig Andur Pedersen (Roskilde University)
- 279/94 Description of a method of measuring the shear modulus of supercooled liquids and a comparison of their thermal and mechanical response functions.
af: Tage Christensen
- 280/94 A Course in Projective Geometry
by Lars Kadison and Matthias T. Kromann
- 281/94 Modellering af Det Cardiovasculære System med Neural Puls kontrol
Projektrapport udarbejdet af:
Stefan Frello, Runa Ulsøe Johansen, Michael Poul Curt Hansen, Klaus Dahl Jensen
Vejleder: Viggo Andreassen
- 282/94 Parallele algoritmer
af: Erwin Dan Nielsen, Jan Danielsen, Niels Bo Johansen

- 283/94 Grænser for tilfældighed
(en kaotisk talgenerator)
af: Erwin Dan Nielsen og Niels Bo Johansen
- 284/94 Det er ikke til at se det, hvis man ikke
lige ve' det!
Gymnasie matematikkens begrundelsesproblem
En specialerapport af Peter Hauge Jensen
og Linda Kyndlev
Vejleder: Mogens Niss
- 285/94 Slow coevolution of a viral pathogen and
its diploid host
by: Viggo Andreassen and
Freddy B. Christiansen
- 286/94 The energy master equation: A low-temperature
approximation to Bässler's random walk model
by: Jeppe C. Dyre
- 287/94 A Statistical Mechanical Approximation for the
Calculation of Time Auto-Correlation Functions
by: Jeppe C. Dyre
- 288/95 PROGRESS IN WIND ENERGY UTILIZATION
by: Bent Sørensen
- 289/95 Universal Time-Dependence of the Mean-Square
Displacement in Extremely Rugged Energy
Landscapes with Equal Minima
by: Jeppe C. Dyre and Jacob Jacobsen
- 290/95 Modellering af uregelmæssige bølger
Et 3.modul matematik projekt
af: Anders Marcussen, Anne Charlotte Nilsson,
Lone Michelsen, Per Mørkegaard Hansen
Vejleder: Jesper Larsen
- 291/95 1st Annual Report from the project
LIFE-CYCLE ANALYSIS OF THE TOTAL DANISH
ENERGY SYSTEM
an example of using methods developed for the
OECD/IEA and the US/EU fuel cycle externality study
by: Bent Sørensen
- 292/95 Fotovoltaisk Statusnotat 3
af: Bent Sørensen
- 293/95 Geometridiskussionen - hvor blev den af?
af: Lotte Ludvigsen & Jens Frandsen
Vejleder: Anders Madsen
- 294/95 Universets udvidelse -
et metaprojekt
Af: Jesper Duelund og Birthe Friis
Vejleder: Ib Lundgaard Rasmussen
- 295/95 A Review of Mathematical Modeling of the
Controlled Cardiovascular System
By: Johnny T. Ottesen
- 296/95 RETIKULER den klassiske mekanik
af: Peder Voetmann Christiansen
- 297/95 A fluid-dynamical model of the aorta with
bifurcations
by: Mette Olufsen and Johnny Ottesen
- 298/95 Mordet på Schrödingers kat - et metaprojekt om
to fortolkninger af kvantemekanikken
af: Maria Hermannsson, Sebastian Horst,
Christina Specht
Vejledere: Jeppe Dyre og Peder Voetmann Christiansen
- 299/95 ADAM under figenbladet - et kig på en samfunds-
videnskabelig matematisk model
Et matematisk modelprojekt
af: Claus Dræby, Michael Hansen, Tomas Højgård Jensen
Vejleder: Jørgen Larsen
- 300/95 Scenarios for Greenhouse Warming Mitigation
by: Bent Sørensen
- 301/95 TOK Modellering af træers vækst under påvirkning
af ozon
af: Glenn Møller-Holst, Marina Johannessen, Birthe
Nielsen og Bettina Sørensen
Vejleder: Jesper Larsen
- 302/95 KOMPRESSORER - Analyse af en matematisk model for
aksialkompressorer
Projektrapport af: Stine Bøggild, Jakob Hilmer,
Pernille Postgaard
Vejleder: Viggo Andreassen
- 303/95 Masterlignings-modeller af Glasovergangen
Termisk-Mekanisk Relaksation
Specialerapport udarbejdet af:
Johannes K. Nielsen, Klaus Dahl Jensen
Vejledere: Jeppe C. Dyre, Jørgen Larsen
- 304a/95 STATISTIKNOTER Simple binomialfordelingsmodeller
af: Jørgen Larsen
- 304b/95 STATISTIKNOTER Simple normalfordelingsmodeller
af: Jørgen Larsen
- 304c/95 STATISTIKNOTER Simple Poissonfordelingsmodeller
af: Jørgen Larsen
- 304d/95 STATISTIKNOTER Simple multinomialfordelingsmodeller
af: Jørgen Larsen
- 304e/95 STATISTIKNOTER Mindre matematisk-statistisk opslagsværk
indeholdende bl.a. ordforklaringer, resuméer og
tabeller
af: Jørgen Larsen

- 305/95 The Maslov Index:
A Functional Analytical Definition
And The Spectral Flow Formula
By: B. Booss-Bavnbek, K. Furutani
- 306/95 Goals of mathematics teaching
Preprint of a chapter for the forthcoming International Handbook of Mathematics Education (Alan J. Bishop, ed)
By: Mogens Niss
- 307/95 Habit Formation and the Thirdness of Signs
Presented at the semiotic symposium
The Emergence of Codes and Intensions as a Basis of Sign Processes
By: Peder Voetmann Christiansen
- 308/95 Metaforer i Fysikken
af: Marianne Wilcken Bjerregaard, Frederik Voetmann Christiansen, Jørn Skov Hansen, Klaus Dahl Jensen, Ole Schmidt
Vejledere: Peder Voetmann Christiansen og Petr Viscor
- 309/95 Tiden og Tanken
En undersøgelse af begrebsverdenen Matematik udført ved hjælp af en analogi med tid
af: Anita Stark og Randi Petersen
Vejleder: Bernhelm Booss-Bavnbek
-
- 310/96 Kursusmateriale til "Lineære strukturer fra algebra og analyse" (E1)
af: Mogens Brun Heefelt
- 311/96 2nd Annual Report from the project
LIFE-CYCLE ANALYSIS OF THE TOTAL DANISH ENERGY SYSTEM
by: Hélène Connor-Lajambe, Bernd Kuemmel, Stefan Krüger Nielsen, Bent Sørensen
- 312/96 Grassmannian and Chiral Anomaly
by: B. Booss-Bavnbek, K.P. Wojciechowski
- 313/96 THE IRREDUCIBILITY OF CHANCE AND THE OPENNESS OF THE FUTURE
The Logical Function of Idealism in Peirce's Philosophy of Nature
By: Helmut Pape, University of Hannover
- 314/96 Feedback Regulation of Mammalian Cardiovascular System
By: Johnny T. Ottesen
- 315/96 "Rejsen til tidens indre" - Udarbejdelse af a + b et manuskript til en fjernsynsudsendelse + manuskript
af: Gunhild Hune og Karina Goyle
Vejledere: Peder Voetmann Christiansen og Bruno Ingemann
- 316/96 Plasmaoscillation i natriumklynger
Specialerapport af: Peter Meibom, Mikko Østergård
Vejledere: Jeppe Dyre & Jørn Borggreen
- 317/96 Poincaré og symplektiske algoritmer
af: Ulla Rasmussen
Vejleder: Anders Madsen
- 318/96 Modelling the Respiratory System
by: Tine Guldager Christiansen, Claus Draby
Supervisors: Viggo Andreasen, Michael Danielsen
- 319/96 Externality Estimation of Greenhouse Warming Impacts
by: Bent Sørensen
- 320/96 Grassmannian and Boundary Contribution to the -Determinant
by: K.P. Wojciechowski et al.
- 321/96 Modelkompetencer - udvikling og afprøvning af et begrebsapparat
Specialerapport af: Nina Skov Hansen, Christine Iversen, Kristin Troels-Smith
Vejleder: Morten Blomhøj
- 322/96 OPGAVESAMLING
Bredde-Kursus i Fysik 1976 - 1996
- 323/96 Structure and Dynamics of Symmetric Diblock Copolymers
PhD Thesis
by: Christine Maria Papadakis
- 324/96 Non-linearity of Baroreceptor Nerves
by: Johnny T. Ottesen
- 325/96 Retorik eller realitet ?
Anvendelser af matematik i det danske Gymnasiums matematikundervisning i perioden 1903 - 88
Specialerapport af Helle Pilemann
Vejleder: Mogens Niss
- 326/96 Bevist teori
Eksemplificeret ved Gentzens bevis for konsistensen af teorien om de naturlige tal
af: Gitte Andersen, Lise Mariane Jeppesen, Klaus Frovin Jørgensen, Ivar Peter Zeck
Vejledere: Bernhelm Booss-Bavnbek og Stig Andur Pedersen
- 327/96 NON-LINEAR MODELLING OF INTEGRATED ENERGY SUPPLY AND DEMAND MATCHING SYSTEMS
by: Bent Sørensen
- 328/96 Calculating Fuel Transport Emissions
by: Bernd Kuemmel

- 329/96 The dynamics of cocirculating influenza strains conferring partial cross-immunity and
A model of influenza A drift evolution
by: Viggo Andreasen, Juan Lin and Simon Levin
- 330/96 LONG-TERM INTEGRATION OF PHOTOVOLTAICS INTO THE GLOBAL ENERGY SYSTEM
by: Bent Sørensen
- 331/96 Viskøse fingre
Specialerapport af:
Vibeke Orlien og Christina Specht
Vejledere: Jacob M. Jacobsen og Jesper Larsen
-
- 332/97 ANOMAL SWELLING AF LIPIDE DOBBELTLAG
Specialerapport af:
Stine Sofia Korremann
Vejleder: Dorthe Posselt
- 333/97 Biodiversity Matters
an extension of methods found in the literature on monetisation of biodiversity
by: Bernd Kuemmel
- 334/97 LIFE-CYCLE ANALYSIS OF THE TOTAL DANISH ENERGY SYSTEM
by: Bernd Kuemmel and Bent Sørensen
- 335/97 Dynamics of Amorphous Solids and Viscous Liquids
by: Jeppe C. Dyre
- 336/97 PROBLEM-ORIENTATED GROUP PROJECT WORK AT ROSKILDE UNIVERSITY
by: Kathrine Legge
- 337/97 Verdensbankens globale befolkningsprognose - et projekt om matematisk modellering
af: Jørn Chr. Bendtsen, Kurt Jensen, Per Pauli Petersen
Vejleder: Jørgen Larsen
- 338/97 Kvantisering af nanolederes elektriske ledningsevne
Første modul fysikprojekt
af: Søren Dam, Esben Danielsen, Martin Niss, Esben Friis Pedersen, Frederik Resen Steenstrup
Vejleder: Tage Christensen
- 339/97 Defining Discipline
by: Wolfgang Coy
- 340/97 Prime ends revisited - a geometric point of view -
by: Carsten Lunde Petersen
- 341/97 Two chapters on the teaching, learning and assessment of geometry
by Mogens Niss
- 342/97 LONG-TERM SCENARIOS FOR GLOBAL ENERGY DEMAND AND SUPPLY
A global clean fossil scenario discussion paper prepared by Bernd Kuemmel
Project leader: Bent Sørensen
- 343/97 IMPORT/EKSPORT-POLITIK SOM REDSKAB TIL OPTIMERET UDNYTTELSE AF EL PRODUCERET PÅ VE-ANLÆG
af: Peter Meibom, Torben Svendsen, Bent Sørensen
- 344/97 Puzzles and Siegel disks
by Carsten Lunde Petersen
-
- 345/98 Modeling the Arterial System with Reference to an Anesthesia Simulator
Ph.D. Thesis
by: Mette Sofie Olufsen
- 346/98 Klyngedannelse i en hulkatode-forstøvningsproces
af: Sebastian Horst
Vejledere: Jørn Borggren, NBI, Niels Boye Olsen
- 347/98 Verificering af Matematiske Modeller - en analyse af Den Danske Eulerske Model
af: Jonas Blomqvist, Tom Pedersen, Karen Timmermann, Lisbet Øhlenschläger
Vejleder: Bernhelm Booss-Bavnbek
- 348/98 Case study of the environmental permission procedure and the environmental impact assessment for power plants in Denmark
by: Stefan Krüger Nielsen
Project leader: Bent Sørensen
- 349/98 Tre rapporter fra FAGMAT - et projekt om tal og faglig matematik i arbejdsmarkedsuddannelserne
af: Lena Lindenskov og Tine Wedege
- 350/98 OPGAVERSAMLING - Bredde-Kursus i Fysik 1976 - 1998
Erstatter teksterne 3/78, 261/93 og 322/96
- 351/98 Aspects of the Nature and State of Research in Mathematics Education
by: Mogens Niss

- 352/98 The Herman-Swiatec Theorem with applications
by: Carsten Lunde Petersen
- 353/98 Problemløsning og modellering i en almindelig matematikundervisning
Specialerapport af: Per Gregersen og Tomas Højgaard Jensen
Vejleder: Morten Blomhøj
- 354/98 A GLOBAL RENEWABLE ENERGY SCENARIO
by: Bent Sørensen and Peter Meibom
- 355/98 Convergence of rational rays in parameter spaces
by: Carsten Lunde Petersen and Gustav Ryd
- 356/98 Terrænmodellering
Analyse af en matematisk model til konstruktion af terrænmodeller
Modelprojekt af: Thomas Frommelt, Hans Ravnkjær Larsen og Arnold Skimminge
Vejleder: Johnny Ottesen
- 357/98 *Cayleys Problem*
En historisk analyse af arbejdet med Cayley problem fra 1870 til 1918
Et matematisk videnskabsfagsprojekt af:
Rikke Degn, Bo Jakobsen, Bjarke K.W. Hansen, Jesper S. Hansen, Jesper Udesen, Peter C. Wulff
Vejleder: Jesper Larsen
- 358/98 *Modeling of Feedback Mechanisms which Control the Heart Function in a View to an Implementation in Cardiovascular Models*
Ph.D. Thesis by: Michael Danielsen
- 359/99 *Long-Term Scenarios for Global Energy Demand and Supply Four Global Greenhouse Mitigation Scenarios*
by: Bent Sørensen
- 360/99 **SYMMETRI I FYSIK**
En Meta-projektrapport af: Martin Niss, Bo Jakobsen & Tine Bjarke Bonné
Vejleder: Peder Voetmann Christiansen
- 361/99 *Symplectic Functional Analysis and Spectral Invariants*
by: Bernhard Booss-Bavnbek, Kenro Furutani
- 362/99 *Er matematik en naturvidenskab? - en udspænding af diskussionen*
En videnskabsfagsprojekt-rapport af Martin Niss
Vejleder: Mogens Nørgaard Olesen

TEKST NR 417

2003

**the Semiotic Flora of
Elementary particles**



Peder Voetmann Christiansen

TEKSTER fra

IMFUFA

ROSKILDE UNIVERSITETSCENTER
INSTITUT FOR STUDIET AF MATEMATIK OG FYSIK SAMT DERES
FUNKTIONER I UNDERVISNING, FORSKNING OG ANVENDELSER

IMFUFA- Roskilde Universitetscenter- postbox 260- DK4000 Roskilde
Tlf:46742263- Fax 46743020-Mailimfufa@ruc.dk
Peder Voetmann Christiansen
The Semiotic Flora of Elementary Particles
IMFUFA tekst nr. 417-24 sider- ISBN 0106-6242

Abstract

This paper refers (but adds nothing) to the standard model of elementary particles, but present many of these particles in a "botanical" way, like the flowers in a Flora. The vacuum-background for the particles is treated with special emphasis on the zero-point-energy and its measurable effect — the Casimir effect. The special importance of the number 3 in the standard model leads to the idea that classification may be based on C.S. Peirce's *triadic* philosophy of signs — his *Semiotic*. A slightly abbreviated danish version of this article will appear in the collection: Thellefsen and Dinesen (ed.) *Semiotiske Undersøgelser*, Gyldendal, 2003.

Thanks are due to Bent C. Jørgensen for suggesting the botanical metaphor and to Edwina Taborsky for inspiring applications of Peirce's semiotic to physics.

Contents

Introduction	p. 1
1. The wild vacuum	p. 1
2. Zero point energy	p. 3
3. The vacuum press	p. 4
4. Renormalization — just smart, or?	p. 6
5. the mysterious number 3	p. 8
6. Semiotics of the particle-concept	p. 8
7. Contents of the botany-box.	p.12
8. Semiotic classification of elementary particles.	p. 14
9. Compound particles.	p. 16
10. Conclusion	p. 19
Appendix: Casimir-renormalization	p. 20
Notes and references	p. 22

the semiotic Flora of Elementary Particles

by Peder Voetmann Christiansen.

Introduction

Most natural sciences start out with a *deictic ontology*¹, a view that builds on the distinguishability of objects through nomenclature and placing in a system of classification. Thus, a natural *science* like biology builds on a natural *history*, like botany that through the classification of Linné allows the naming of plants using a well defined system of indexing — a *Flora*. The physics of elementary particles is long past the state of natural history by the use of a strong, but heavy mathematical apparatus in Quantum Field Theory and group-representations. As the particles by and by have become as numerous as flowers we can still use a "Flora" for naming and schematically surveying them. A suitable system for this can be found in Peirce's semiotic. This makes it possible to find a shorter way through the mathematical jungle, and certain regularities that still appear enigmatic in the mathematical theory, seem more understandable in the semiotic perspective.

1. the Wild Vacuum.

the physical concept of a *particle* — a point with mass — is, semiotically speaking, an *icon* — a sign whose object is *potential* or *virtual*. The particle as the physical object the icon refers to has definite properties, but not necessarily *existence*. A virtual particle is just a possibility for excitation of the physical vacuum — the empty space. That space is *empty* does not mean that it is without properties. It has three types of properties, viz. *optical*, *topological*, and *metrical* properties. The *optical* properties^{*)}

entail that space has three dimensions and is *seen* as delimited by a *heavenly sphere* which has no physical existence. Two parallel lines (light rays) are seen as in the painter's perspective (CP 6.26) intersecting each other in two diametrically opposite points and all possible points of infinity make up "a line in the infinite" i.e. a great circle on the heavenly sphere, called the *horizon*.^{**)} The topological properties are described by Peirce with four integers, the so called *Listing numbers*¹ *chorisis*, *cyclosis*, *periphaxis*, and *immensity* that characterize every three-dimensional object: *Chorisis* is the number of separate pieces that make up the object. *Cyclosis* is the number of through-going holes or singularities with axial symmetry (like vortices). *Periphaxis* is the number of internal, three-dimensional holes, and *Immensity* is a number that

^{*)} Peirce uses the name *optic* for the discipline that is now called *projective Geometry*. Topology he calls *topic*. Peirce claims that *optic* and *topic* should precede *metric*.

^{**)} Every plane bundle of parallel directions of view has a horizon, and all horizons together make up the heavenly sphere.

is only different from zero for an unlimited body. Looking at the whole universe it will have choris and immensity equal to one, while its cyclosis and periphaxis are unknown quantities reflecting singularities in the *metric* of space. The field equations of General Relativity that combine the metrical properties with the field of gravitation show that there are possible singularities corresponding to both types: *Cosmic Strings* add to the *Cyclosis* of space and *Black Holes* add to its *Periphaxis*. How many there are of such objects in the visible universe is not known, but observations indicate the both types exist.

Within the normally accessible scales of length and energy the physical vacuum appears completely without structure. It is, though, not without properties, but hides itself under three fundamental constants of nature, viz:

- 1: $c=3 \cdot 10^8$ m/s; the velocity of light in vacuum.
- 2: $\hbar=h/2\pi=10^{-34}$ J·s Dirac's quantum of action. (h is Planck's constant).
- 3: $G=6.67 \cdot 10^{-13}$ N·m²/kg² Newton's constant of gravitation.

Expressed as here in normal (SI) units the numerical values of these constants are either very big or very small, but that just means that the SI-units (length in meters (m), time in seconds (s), and mass in kilograms (k)) are "human measures", far away from the world of elementary particles. However, it is possible to choose units of length, time, and mass, such that the three constants of nature, mentioned above, all get the value of unity in these new units, the so called Planck-units.

$$\begin{aligned} \text{the Planck-length is then:} & \quad L_p = \sqrt{(\hbar G/c^3)} = 4 \cdot 10^{-36} \text{ m} \\ \text{the Planck-time is:} & \quad t_p = L_p/c = 10^{-44} \text{ s,} \\ \text{and the Planck-mass is} & \quad M_p = \sqrt{(\hbar c/G)} = 5 \cdot 10^{-7} \text{ kg.} \end{aligned}$$

A natural starting point for pictures of elementary particles is then a sphere with radius one Planck-length and mass one Planck-mass. Compared to ordinary elementary particles (like electrons) the Planck-particle is of very small extension, but very heavy (ca 0.5 mg).

The force of gravity on the surface of such a particle will be so strong, that the particle "swallows itself" and becomes a mini-black hole. This has never been observed, and will probably never be, since the Planck-energy $M_p \cdot c^2 = 10^{18}$ GeV is far beyond the range of even the largest accelerators. Perhaps there has been many of them when the universe was only one Planck-time old, but as "mini-black-holes" quickly evaporate by a process called Hawking-radiation, they have all disappeared long ago. If we could view the physical vacuum through a microscope with a resolution of one Planck-length we would likely see that space on these scales is not without structure, but has both *cyclosis* (from superstrings) and *Periphaxis* (from mini-black-holes). Topology (and hence also metric) is *chaotic* on the Planck-scale, both in space and time.

2. Zero point energy.

In the holistic "New Age Philosophy's" critique of physical reductionism (as expressed, e.g. by David Bohm) one often sees the assertion that the physical vacuum contains infinite amounts of energy².

Even the smallest volume, like a cubic millimeter should, according to this conception, contain enough of energy to sustain the whole world for many years^{*)}

We shall see how such an idea can arise from a — basically correct — application of physical principles and why it is, despite of this, altogether wrong.

Let us consider a small part of space delimited by two parallel metal plates separated by a distance L . *Between such plates* there can be a series of electromagnetic oscillation-modes that are standing waves whose *half wavelength* is a whole fraction of the distance L . Like for an oscillating string or a closed organ-pipe we can distinguish between a *ground-tone* with the wavelength $2L$ and an infinite series of *overtones*, where the n th overtone has the wavelength $2L/(n+1)$. The ground-tone has $n=0$ and the overtones have n from 1 to ∞ . The frequency of oscillation of each such mode is found by dividing the wavelength up into the velocity of light c . Thus, the ground-tone has the frequency $\nu=c/2L$. Every mode can be considered as a *harmonic oscillator*, and according to Quantum Mechanics it can only have the discrete energy-values

$$E_m = (m + \frac{1}{2})h\nu$$

where m is a positive integer or zero. We see that the energy is *quantized* with the quantum $h\nu$.

Such field-quanta can be regarded as particles, and when it, like here, are quanta of an electromagnetic "light-field" we call the particles *photons*. Likewise, we speak of *phonons* when it is a sound-field like the oscillations on a string that are quantized. (c should then be the velocity of *sound*). If the n th mode is excited to the m th level we say that there are m photons (phonons) in the *state* n . Thus, the ground state of vacuum is the one where $m=0$ for all the states. From the above formula for the energy-values we see that the energy of each mode in its ground-state is not zero, but carries the zero-point-energy $h\nu/2$. As there are infinitely many modes in the cavity, the total zero-point-energy is infinite. This, however, is a purely formal consideration that does not consider the semantic purport in the concept of energy, namely *ability to perform work*. If an oscillator is excited to level m it can perform work by delivering a quantum $h\nu$ to the surroundings whereby the oscillator itself makes a transition to level $m-1$. This, however, is impossible, if the oscillator is in the ground-state $m=0$, because there are no lower levels. So, the infinite vacuum-energy turns out to be a fiction, and a "perpetuum mobile of the third kind" is an impossibility like all other kinds of perpetuum mobile.

One should not, however, entirely disregard the zero-point-energy as being unreal, because it shows itself in other ways than the ability to perform work, namely by the *pressure* it exerts on the surroundings. The so called *Casimir-effect* is an experimental demonstration of this pressure.³

The zero-point-energy has physical actions and is therefore, according to Peirce's pragmatic criterion of meaning, real. This assertion leads naturally to the question "From where did it come?" This is a mischievous question that leads to the mischievous answer: "We

*) A hypothetical engine that can extract the vacuum energy is called a "Perpetuum Mobile of the third kind".

made it ourselves!" There is, namely, a concept-logical connection between *localizing* a particle (to ensure that it is situated in a certain, limited region of space) and to *transfer energy to it*. This connection is expressed in *Heisenberg's uncertainty relation*

$$\Delta x \cdot \Delta p > h$$

where Δx is the uncertainty of spatial location and Δp the uncertainty of momentum (mass times velocity). If we try to localize the particle strongly, i.e. make Δx very small, then Δp will be, correspondingly, greater. The particle will not rest quietly when we keep it in a narrow cage, and therefore we have to perform work by narrowing its limits — a work that adds to the kinetic energy of the particle. This argument is also valid when there is no particle. For example there are *no photons* when all the oscillatory modes are in their ground-state. The zero-point-energy of the photon-field's ground state is, according to the previous derivation $hc/4L$, i.e. it increases when we diminish L and the increase comes from the work we do by the compression.

3. The Vacuum Press

Let us perform a thought-experiment wherein we compress the vacuum by means of the apparatus shown in figure 1. The cavity-length L is here the distance between the piston and the bottom of the box.

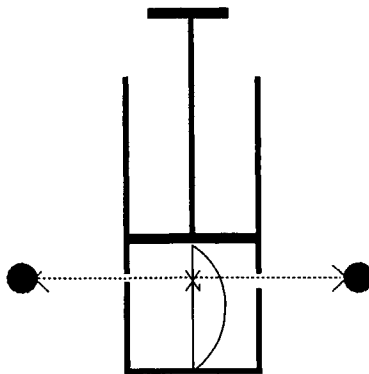

Figure 1 the vacuum press

When we press down the piston we change the wavelength of the ground-mode and thereby increase the zero-point-energy. For sufficiently small values of L the zero-point-energy will be greater than the relativistic rest-energy mc^2 of a particle of mass m . This, however, is not sufficient to create the particle, because, if it emerges within the box it will have a "localization-kinetic-energy" according to Heisenberg's uncertainty relation, and this energy increases faster (inversely proportional to L^2) when L decreases and therefore there will never be enough of zero-point-energy in the photon-field to create a particle with mass. If there are holes in the box potentially existing particles may escape and then have no localization-energy. There will then be enough of energy in the photon-field to create an electron when L becomes smaller than the *Compton wavelength* of the electron $\lambda_c = \hbar/mc \approx 3 \cdot 10^{-13}$ m., where $m \approx 9 \cdot 10^{-31}$ kg is the mass of the electron.

When we try to press the piston to the bottom various particles will sprout from the holes like seeds of an orange when L passes below their respective Compton wavelengths.

The Compton wavelength puts a natural limit to how narrowly a particle may be localized. If we think of the particle as a small hard sphere, we can think of the Compton wavelength as the radius of the sphere. The radius of the electron is then ca 1000 times as small as the radius of a hydrogen atom and ca 2000 times as big as the radius of the atomic nucleus (the proton). In the Planck system of units (where $\hbar=1$ and $c=1$) the radius of the particle is simply the reciprocal of its mass. A particle of one Planck-mass (a mini-black-hole) will have radius one Planck-length — the smallest distance that can be connected with classical conceptions of space-time.

It may seem contradictory when we claim that the zero-point-energy cannot perform work but is yet able to produce particles. The explanation is, again, that the holes in the box, that allow the particles to escape also makes it possible for the zero-point-oscillation to yield, i.e. decrease its frequency and thereby its energy. Still, we maintain that the work comes from the compression of the piston and the zero-point mode is only an intermediate storage-medium for the energy.

The most efficient method of compressing space consists in providing two massive particles with a high velocity in an *accelerator* and then arranging a *collision* between these particles. In CERN's (newly abolished) LEP (Large- Electron-Positron-Collider) the collision-energies reached about 100 GeV, and that is not quite sufficient to produce the currently most

interesting particles (as the Higgs-boson^{*)}. A new accelerator LHC (Large Hadron Collider) will, within a few years yield significantly higher collision energy by using hadrons (like protons) that are about 200 times more massive than electrons (and thereby also more compressed beforehand).

4. Renormalisation — just smart, or a bit too smart?

The previous discussion of the vacuum press and the Casimir effect (the pressure on the piston) is incomplete, because it only takes into account the ground-mode of the photon-field. Naturally we must also regard the infinity of overtones, but that leads to the problem that the total zero-point-energy (and thereby also the pressure) becomes infinite. The zero-point energy of the n th mode is:

$$E_n = \frac{1}{2} h \nu_n = hc \cdot (n+1) / 4L$$

It is therefore clear that the complete zero-point-energy includes a factor that is the sum of all positive integers from 1 to ∞ , and this factor must, for a normal consideration, be infinitely great. This we could, perhaps, learn to accept, for, as we have seen, the zero-point-energy cannot perform work, so we could disregard it as being non-energy. But it's not so easy. Every single mode gives rise to an upward-directed force on the piston that is $K_n = -dE_n/dL$ and the sum of all these forces will contain the same infinite factor, such that the pressure (measurable) becomes infinite, which it clearly isn't in reality.

Casimir's calculations, as well as Spaarnay's experiment even show that the pressure is negative, i.e. the force on the piston is directed downwards. We are, therefore, forced to "explain away" or *renormalize* this infinity. A way to do this is by using a mathematical technique called *analytic continuation*. A very important function in Mathematics is *Riemann's zetafunction* $\zeta(z)$ that is defined for *complex numbers* $z=x+iy$ in the following way:

$$\zeta(z) = \sum_{n=1}^{\infty} \frac{1}{n^z}$$

This definition is entirely clear for all z whose real part, x , is greater than 1, because then the series converges to a finite value. However, the function has a unique *analytical continuation* to the whole complex plane, including negative real values of z , where the series is divergent. Formally, we can put $z=-1$, whereby the infinite sum becomes the previously mentioned sum of all positive integers, and we can assign it a value given by the analytical continuation of the zetafunction to $z=-1$. In this way we get at the renormalized value $\zeta(-1)$

^{*)} The most interesting particles are those predicted theoretically but not yet found with certainty experimentally.

$=-1/12^4$, i.e. not only have we transmuted the infinite factor to something finite we have even given it the correct sign! In a similar way we can "prove" other absurdities, e.g. that $\infty = -1/2$, for if we put $z=0$ in the above formula we get a sum of infinitely many 1s, i.e. ∞ , and the analytical continuation $\zeta(0)$ has the value $-1/2$.

Such a mathematical renormalization-technique appears "a bit too smart" because it may lead to screaming absurdities, but the method should not be entirely rejected, as it is, in fact, applied and often leads to results that are completely correct. An example is the so called *factorial function* $n! = 1 \cdot 2 \cdot 2 \cdots n$, i.e. the number of permutations of n objects, that is defined for positive integers n . An analytical continuation employing the so called Gammafunction allows us to define $(-1/2)! = \sqrt{\pi}$, a result that no mathematician or physicist will cast in doubt^{*)}. We shall not "throw out the baby with the bathing water" by prohibiting renormalization by analytical continuation, but still, I want to go through a physical argument of argumentation reflecting Casimir's calculation and, hopefully, making it a little less suspect. I shall give a short outline of the argument here, while the details can be found in the appendix.

Hitherto, we have only considered the electromagnetic modes in the cavity *below* the piston in figure 1. This infinity of modes, all have wavelengths less than $2L$. However, they exist also *above* the piston, where each of them gives rise to a *downwardly* directed force that precisely cancels the *upwardly* directed force from the corresponding mode below the piston. In this way we remove the infinity, so what is left?

There are all the modes whose wavelength is *greater* than $2L$, and these modes are only found *above* the piston. By adding the forces from these modes one finds that the resulting force on the piston is *downwardly* directed with the finite value

$$K_{total} = -hc/8L^2$$

Curiously enough the previous "bit too smart" renormalization argument gives almost the same, viz. $K_{total} = -hc/48L^2$, i.e. the correct sign and only a factor 6 smaller than the right numerical value.

The Casimir "pressure" is thus a "suction" (because K_{total} is negative) but it can only be felt when L is very small (of atomic size). If we accept that the vacuum is *empty*, so that the energy density is zero in the *external* vacuum above the piston, we can interpret the *suction* of the Casimir effect saying that the vacuum *below* the piston has *negative* energy density. It thus corresponds to so called *exotic matter* that is required to make *worm holes* in space-time to be used by time-travellers⁵.

^{*)} By combination with the previous "result" $\infty = -1/2$ we have thus "proved" that $\infty! = \sqrt{\pi}$, that the product of all positive integers from 1 to ∞ has the finite value $\sqrt{\pi}$ (1.77), but then we seem to have renormalized ourselves entirely out of reality — all too smart!

If the vacuum press in figure 1 shall be able to squeeze particles out of vacuum, the pressure must be positive. The calculation above, giving a negative pressure can therefore only be valid for distances L larger than the Compton wavelengths of the virtual particles.

The reason why I've given a relatively lengthy discussion of vacuum is to avoid that the following enumeration of particles and their properties should be regarded as reductionistic: We need a holistic conception: The whole is more than the sum of its parts — the elementary particles don't have properties that are independent of their context. A particle is a *field-quantum* and interacts with virtual fields in vacuum. We cannot calculate the properties of one single free particle, e.g. its mass, for its properties reflect the wild vacuum, although it is not quite as wild as certain "quantum holists" claim (infinite energy density, etc.)

5. The mysterious number 3.

In a popular "nature-historic" account of the elementary particles⁶ the author seems puzzled about "two mysterious 3-numbers" that have emerged in later years in particle-physics:

- 1) There are three *generations* of elementary particles, and
- 2) The heavy nuclear particles — *baryons* (as the proton and the neutron) consist of *three quarks*.

We can easily expand the list over the fundamental roles of the number 3: Space has three dimensions and three types of properties (chapter 1). There are three types of units (length, mass, and time) and three fundamental constants of nature (\hbar , c , and G). The quarks have three "colours" (red, green, and blue) and strange electric charges that are not built of the electron's charge e as the quantum of charge, but of $1/3e$.

Previously one got used to *dichotomies*, or *two-partitions*: There are *Fermions* (as electrons and quarks with *half-integer* spin, usually $1/2$) and *bosons* with integer-spin (0 for π mesons, 1 for photons, and 2 for gravitons). There are *particles* and *antiparticles*, and there are *positively* and *negatively* charged particles with *even* or *odd parity*. These *dichotomies* can be understood from the concept of *mirroring*. The mirror-image of a *particle* with *negative* charge and *even* parity will be an *antiparticle* with *positive* charge and *odd* parity, but the newly discovered *trichotomies* are not connected to mirroring and therefore appear strange. I shall not attempt to seek a mathematical justification of the trichotomies but instead take departure from a philosophy that is built on trichotomies and thereby make the "mysterious" number 3s appear as something natural and inevitable, namely *Peirce's Semiotic*.

6. Semiotics of the particle-concept

A previous article by the author⁷ explained how Peirce's triadic doctrine of categories implies that signs can be divided in classes that can be put up in triangular schemes.

On the most elementary level of description a sign is something that mediates between an *object* and an *interpretant*, schematically I---O where the line stands for the sign-vehicle — a physical signal or link between O and I. By using Peirce's categories we can distinguish between three types of links or mediating processes:

- 1: A *potential* link that only exists as a possibility. The sign is then called an *icon*.
- 2: An *actual* link from an existing object is an *index*.
- 3: A *general* link referring to a general class of objects defines a *symbol*.

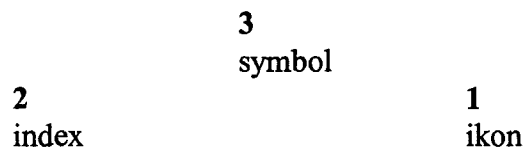

Figure 2 Sign classes for the 1-link relation

On the next level of description the sign-vehicle, or the *Representamen* R is objectified and gets two links to O and I after the scheme I---R---O. These two links represent the elementary quantum processes *Preparation* (R---O) and *detection* (I---R) and each of them can be classified by the three categories, though only such that the category of the detection-link cannot exceed that of the preparation-link. In this way we arrive at *the six quantum-semiotic sign classes* shown in figure 3:

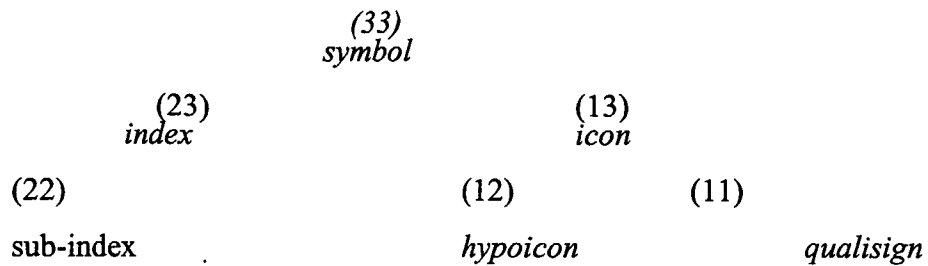

Figure 3 The 6 quantum-semiotic sign classes for the two-link relation I---R-

↪--O.

As the interpretant I is to be regarded as a sign-vehicle (representamen for a new interpretant J, we are lead on to consider a three-link relation J---I---R---O consisting of the two two-link relations 1: I---R---O, and 2: J---I---R, where we see that the I of the first relation appears as representamen in the second relation, and R in the first relation appears as object in the second relation. When we, as before assign the links categories that cannot increase when we move left in the diagram we find Peirce's 10 classes of signs (CP2.256) arranged in a *Pythagorean Tetraktys* (figure 4)

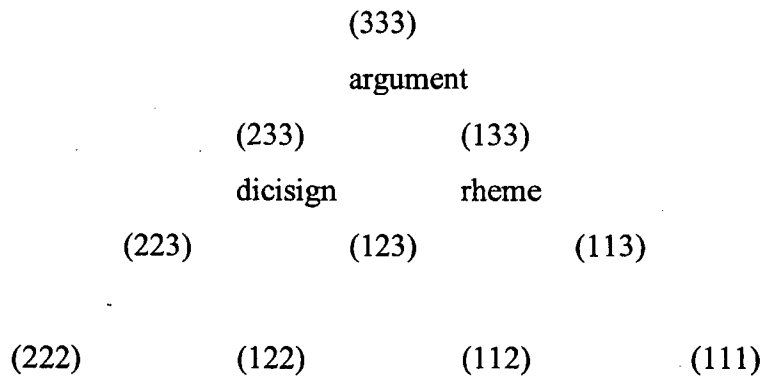

figure 4 the 10 sign classes for the three-link-relation. The 6 classes from figure 3 are the ones, that have 1 in the first place: (111)-(133).

We shall mainly employ the 6 quantum-semiotic sign-classes on figure 3. A *particle* is a *quantum of a field* and therefore has two "handles" or links corresponding to the two fundamental quantum processes *preparation* and *detection*.

There is a clear line of development in the scheme of figure 3, starting with the qualisign 11 and continuing with successive *actualizations* of potential links (1 to 2) and *generalizations* of actual links (2 to 3) without skipping any intermediate stages on the way to the symbol 33. I shall briefly sketch a "nature-historic" interpretation of the sign classes in the right order with hints to particle physics.

11-the qualisign is the empty space, only containing *virtual* fields and particles, like the electromagnetic modes, that can be occupied by photons, but otherwise are in the ground state.

12-the hypoicon can be thought of as a *superstring* — en string i vacuum⁸, having certain field-and particle-properties, reflecting how the string is wound up in other dimensions than the one it is stretching in, The theory of superstrings operates with 8 hidden spatial dimensions and is *supersymmetrical* with regard to Fermion- or Boson-properties of the strings.

22- sub-index: the string closes upon itself to a ring with *area*.

13-icon: the ring moves in space and thereby establishes a three-dimensional container-like region. Thus appears the three-dimensional *continuum of quality* that is the premiss for a sign to refer to an object by *likeness* as an icon does. If the ring is creased there will be bumps in the container, corresponding to a non-euclidean metric that reflects gravitation.

23-index: The iconic particle may collide with another and produce a lot of unspecified particles through the action of the vacuum press. This is *indexical semiosis*, not yet generalized to lawlike behavior.

33-symbol: As we learn about the properties of particles we become able to predict results of collisions between known particles and interpret their traces. On this stage both preparation and detection are generalized and we have reached the symbolic level of description.

This account of the evolution of signs is inspired by Edwina Taborsky⁹⁾

7. Contents of the botany-box.

When you go out to botanize, identifying the names of flowers in a *Flora* there are certain concepts you need in your head and certain tools to keep in your box, besides the flora and the lunch-packet, e.g. a magnifying glass for counting petals and stamens. Similarly, the elementary particles are classified by their *internal properties* and their *interactions* with other particles and fields.

The internal properties are *spin, mass, and charge*.

The interactions are *strong, electromagnetic, weak, and gravitational*, here listed after decreasing strength.

All particles, also the massless, as the photon, interact gravitationally. This universal force is described in Einstein's General Theory of Relativity, but because it is so weak and hitherto has evaded a quantum mechanical treatment it has mostly been ignored by elementary particle- (or high energy-) physics. It is known, though, that the field quantum of gravitation, the *graviton* is massless and has spin 2.

All *charged* particles (including quarks and "heavy leptons") interact electromagnetically. The strength of this interaction is determined by the electron's charge e which was long believed to be the universal quantum of charge, until it was discovered that the charges of quarks are $2/3$ or $-1/3 e$.

All *hadrons* (quarks) and *baryons* (nuclear particles consisting of three quarks) interact *strongly and weakly*. The strong interaction was earlier described as mediated by medium-heavy bosons, called *mesons* (π and K), but now we have learned that mesons too are compounds (by a quark and an antiquark). So what is left of the strong interaction is the force between quarks, whose field-quanta are called *gluons* (8 kinds with spin 1)

Quarks and leptons interact with each other through the *weak interaction* whose mediating field quanta are the *intermediate vector-bosons* (3 kinds with spin 1). The uncharged light leptons, the *neutrinos* only interact weakly (and gravitationally).

After this short account of *interactions* now follows a survey of the most important *internal properties* of the particles:

The (rest-) *mass* m and the *Energy* E are connected through Einstein's relation (hvile)massen m og energien E er forbundne med Einsteins relation

$$E = mc^2$$

In the Planck system of units, where $c=1$ they are identical. The most commonly used unit for this quantity is the *electronvolt* eV , that is the energy an electron gets by accelerating through a voltage-drop of 1 volt ($1 eV = 1.6 \cdot 10^{-19}$ J). Besides, we have the multiple units keV (kilo=1000), MeV (Mega = 10^6) and GeV (Giga = 10^9). The electron's mass is ca $500 keV = \frac{1}{2} MeV$, corresponding to $m=9.1 \cdot 10^{-31}$ kg. The photon and the graviton are massless and can therefore only move with the velocity of light. Earlier it was believed that also the neutrinos are massless (they were observed almost simultaneously with the light from the supernova in the big Magellanic Cloud in 1987), but recent experiments in Japan have shown that at least one of the three neutrinos has a mass about $10eV$ about one hundredthousandth of the electron-mass. As a rule of thumb one may assume that the greater mass, the later is the discovery of the particle, because the accessible accelerator-energies have increased gradually from the keV to the GeV -range.

Spin is an internal *angular momentum* (length times momentum) and is quantized in units of \hbar . Earlier it was believed that particles are small hard spheres and that the spin expressed the sphere's rotation about its own axis, but it has turned out that only *integral* spin-values can be interpreted in this way. Now we will say that spin is concerned with how the symbolic representation of the field is changed by a rotation of the coordinate-system used in the description. Spin can be integral or half-integral as the particles are, respectively *bosons* or *fermions*. Fermions are *exclusive*; there can only be one fermion of a given type in a given quantum-state. Bosons, on the contrary, are "social". They are prone to go together in the same

state and form a *condensate* as known from superfluid systems and laser-light (a condensate of photons). The exclusivity of fermions makes it tempting to regard them as the most evident fundamental bricks in an atomic description of matter. Boson-condensates are more apt for describing classical fields. Every fermion has an anti-particle that is different from itself, whereas a boson's anti-particle often (not always) is the same particle. The theory of superstrings (ref. 8) — the newest candidate for a unifying theory of particles and fields is *supersymmetrical* (hence the name), i.e. it postulates that every boson has a fermion-partner, and vice versa. The photon's supersymmetric partner is called the *photino* it has not yet been seen.

Spin $\frac{1}{2}$ particles (like quarks and leptons) can have the spin pointing either *forwards* or *backwards* in the direction of movement. This means that they possess *parity* or *helicity*, i.e. they are different from their mirror images. Neutrinos are *lefthanded* (*spin against movement*), and *antineutrinos* are *righthanded*.

An important theoretical result, *the CPT-theorem* establishes that the theory must be invariant for the combination of three mirror-operations *C*, *P*, and *T*, i.e. changes of sign for, respectively charge (*C*), parity (*P*), and the direction of time (*T*).

8. Semiotic classification of elementary particles.

We must distinguish between proper *elementary particles* and *compound particles* that are built of elementary particles. Elementary particles are, for historical reasons, divided in *three generations*, 1, 2, and 3, whose order corresponds to the order of their discovery, which is connected with the circumstance that the mass (and thereby the necessary accelerator-energy for the production of them) increases from generation 1 to generation 3.

Each generation consists of *two leptons and two quarks*. So, altogether we have 6 leptons and 6 quarks, which makes it tempting to place them in the semiotic classification with 6 sign-classes in figure 3. All these 12 particles are spin $\frac{1}{2}$ fermions, each having their own anti-particle. So, there are really 24 different particles, but in the following we shall disregard

the anti-particles. I cannot, at present, give a proper semiotic reason for the placing of every single particle in the scheme, so I'll just use a heuristic rule that uses the evolutionary sequence of the 6 sign-classes and assume that this order reflects an increasing mass of the particles. Thus, we get the schematic placement of the 6 leptons:

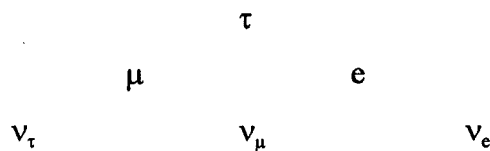

figure 5: the leptons

Generation 1 consists of the electron e and its neutrino ν_e .

Generation 2 consists of the muon μ og its neutrino ν_μ .

Generation 3 consists of the tauon τ and its neutrino ν_τ .

The three "ons" all have the same (negative) charge as the electron $-e$, while the neutrinos are uncharged. As mentioned it is now shown that at least one of the neutrinos has a restmass about $10 eV$, which doesn't give a clue for ordering after increasing mass, so I've just assumed that their mass increases from generation 1 to generation 3 and ordered them accordingly in the lowest row of the scheme.

considering now the *quarks* that are charged spin $\frac{1}{2}$ fermions, we have the following distribution on the generations: For each of the 6 quarks is noted its mass, measured in MeV . *Their charges are given in the left column:*

	generation 1	generation 2	generation 3
+2/3e:	u (<i>up</i>) (5)	c (<i>charm</i>) (350)	t (<i>top</i>) (>80)
-1/3e:	d (<i>down</i>) (9)	s (<i>strange</i>)(160)	b (<i>bottom</i>) (4800)

Figure 6 the three generations of quarks.

We note that for both leptons and quarks the charge-*difference* between the two particles in a generation is always one electron-charge.

The placement of quarks in the semiotic scheme then looks like this:

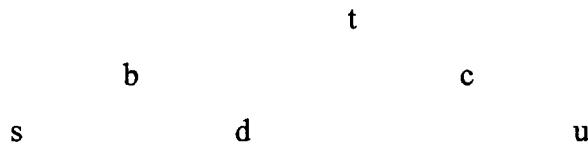

figure 7: the quarks.

The top-quark t is here placed highest in the scheme, because it is the latest discovered, although its mass is not known very precisely.

As earlier mentioned the quarks participate, both in the strong, the electromagnetic, and the weak interactions. Weak interactions are mediated by a *vector-field* analogous to the electromagnetic, whose quanta are spin-1-bosons, as the photon. However, they are not massless as the photon, but, on the contrary, very heavy (90-100 GeV), which has been difficult to understand, but is now explained by assuming that they interact with an uncharged, spin 0 field (a condensate) of so called *Higgs-bosons*, that are not yet seen with certainty in experiments.

The weak interactions make it possible that the heavy quarks may decay to the lighter, e.g. the process

$d \rightarrow u + W^-$ will be possible, when W^- has a single negative charge $-e$ like the electron.

Correspondingly, we have the process

$c \rightarrow d + W^+$ where the positive W^+ is the anti-particle to W^- . Finally we have the possibility

$s \rightarrow d + Z_0$ where Z_0 is uncharged, as s and d both have the charge $-1/3 e$. All these three vector-bosons are discovered at CERN. Because Z_0 is the heaviest of the three, the s -decay runs slower than the d - and c -decays.

9. Compound particles.

The greatest merit of the quark-theory is that it can explain the properties of the heavy fermions — — the *baryons and the intermediately heavy bosons* — the mesons. Earlier it was believed that mesons (especially the *pions* π^+ , π^- , and π^0) were elementary quanta of the field that mediates the strong interactions between baryons, but now we know that all these particles are compounds:

A *baryon* (spin $\frac{1}{2}$ or $\frac{3}{2}$) consists of three quarks

A *meson* (spin 0 or 1) consists of a quark and an anti-quark.

Both quarks and anti-quarks have spin $\frac{1}{2}$, so a meson may have spin 0 or spin 1.

Traditionally known strong interactions, mediated by π -mesons involve only generation 1 quarks u and d. For spin 0 mesons we then have the three possibilities (anti-quarks are denoted with a stroke above the quark-symbol): $(u, \bar{d}) = \pi^+$, $(d, \bar{u}) = \pi^-$ and π^0 or $\eta = (d, \bar{d})^0$, i.e. two charged and two uncharged particles. The diagrams show immediately that π^+ and π^- are each other's anti-particles, while π^0 (og η) are its own anti-particle.

Spin 1 mesons are very unstable and decay rapidly to spin 0 mesons. This family contains, besides π -mesons, also combinations that contain s quarks, namely the K-mesons (kaons)

$K^+ = (u, \bar{s})$, $K^- = (s, \bar{u})$, and $K^0 = (s, \bar{d})$. It is seen that K^+ and K^- are each other's antiparticles, while K^0 is different from anti- K^0 .

For *baryons* it is valid, as mentioned, that each of them consists of *three quarks* and, thus, may have spin $\frac{1}{2}$ or $\frac{3}{2}$. For spin $\frac{3}{2}$ baryons all combinations of the three lightest quarks (u, d, and s) are possible. We may then assign the three quarks the Peircean categories: u=1, d=2, and s=3 and apply the scheme of 3-link sign-relations (figure 4) to the following figure 8:

^{*)} The two uncharged particles π_0 and η are both quantum mechanical mixtures (superpositions) of (u, \bar{u}) and the heavier (d, \bar{d}) .

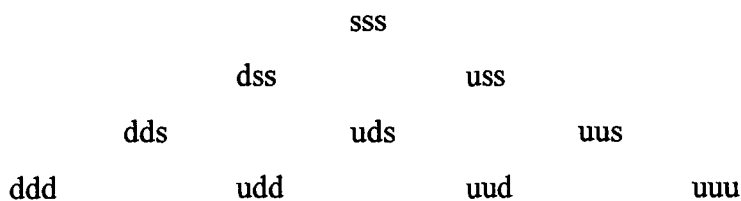

figure 8 the spin-3/2 baryon-decuplet.

This figure is called the spin 3/2 *decuplet* (because it contains 10 particles) is one of the quark-theory's great successes, because it predicts the existence of a hitherto unknown particle, the topmost in the scheme, (sss), called the Ω^- -particle. It carries a negative unit of charge, (as s has the charge $-1/3$) and is rather stable (long-living) because it only decays via the weak interaction with the heavy Z^0 particle.

Spin $1/2$ baryons cannot contain three identical quarks. This rule is coming from Pauli's exclusion principle, that forbids two fermions to occupy the same quantum state. Using again figure 4 (or 8) as our starting point we have to omit the three corners of the triangle, so there are only 7 spin $1/2$ baryons, of which the most important is the *proton* (uud) (charge $+e$) and the *neutron* (udd) (charge 0). Spin 3/2 baryons (except Ω^-) decay rapidly to spin $1/2$ baryons via the strong interactions.

It was a great obstacle for the early quark-theory, that one never sees a single (free) quark. It seems that they only exist three or two at a time, confined in the prison of baryons or mesons. In order to explain why the 3 always were together it was invented to assign them a *colour* or colour-charge, r,g, or b (red,green, or blue). The rule then is, that only "white" particles can appear as free, namely the baryons (rgb) or the mesons (colour+complementary colour, e.g. blue+yellow). In the modern theory of strong interactions, called quantum-chromodynamics (due to the colours) it is assumed that the quarks attract each other with forces that are weak at short distances, but strong at large distances. These forces, that "glue" the quarks together in "white" bundles are mediated by field-quanta that are called *gluons*, what like photons are massless spin-1-particles. As a force between two quarks act between $3 \cdot 3$ colour-combinations, one should think there would be 9 different gluons, but it turns out that the

photon is hiding among these combinations, so there are only 8 gluons. With the high accelerator-energies that are available today, it is possible to tear quarks out from baryons and mesons. They are then seen as "jets", i.e. long stripes, consisting of quarks, anti-quarks, gluons and a lot of other particles, that are created when one with brutal force tear the quarks loose from their attraction.

10. Conclusion.

The particles that are here classified by means of semiotic schemes are all described in the so called *standard model* of elementary particles. we have looked at 63 particles(24 leptons and quarks with anti-particles, 10 spin 3/2 baryons, 7 spin 1/2 baryons, 4 spin 0 mesons, 6 spin 1 mesons, 3 vector bosons, 8 gluons, and 1 Higgs boson). The Higgs-boson is, as mentioned, not yet found with certainty, and that is regarded as a problem for the standard model, because it plays an important role for the understanding why certain particles (as vector-bosons) have mass. The theory indicates, that the Higgs-boson is related to the heavy b-quark and therefore only is produced at very high energies (over 100 GeV).

The semiotic approach is a *schematization*, not a physical theory, like the standard model, that has its own difficulties to fight against, notably the lack of supersymmetry. Superstring theory solves this problem and also includes gravitation, which the standard model has avoided. But, probably, there will still be some use for a "nature-historic" account, as the semiotic, that "steal around" the heavy mathematical apparatus, that the theories require.

Appendix

Casimir-renormalization

As we have seen, a cavity between two plates separated by a distance L may contain an infinity of standing waves whose wavelengths are all smaller than $2L$. The zero point energy of these modes would give rise to an infinite positive (upwards directed) force on the upper plate if it wasn't for the fact that the same modes exist *above* the plate and each of the modes above provide a negative, downwards directed force that precisely cancels the force from below. There are still modes above the plate, not yet taken into account, namely all the modes with wavelengths greater than $2L$. So, let us imagine a second plate with a distance L' from the first plate. The n th mode in the cavity between L and L' will have the wavelength

$$\lambda_n = \frac{2(L' - L)}{n}$$

the frequency of this mode is

$$\nu_n = \frac{c}{\lambda_n} = \frac{cn}{2(L' - L)}$$

and its zero-point energy is

$$E_n = \frac{1}{2} h\nu_n = \frac{hcn}{4(L' - L)}$$

which gives rise to the force

$$K_n = -\frac{dE_n}{dL} = -\frac{hcn}{4(L' - L)^2}$$

The force of the mode as a function of its wavelength λ is then

$$K(\lambda) = -\frac{hc}{2(L'-L)\lambda}$$

In order to sum all these forces we have to find the density of modes. First, the number of modes dn in the frequency-interval $d\nu$ is

$$\frac{dn}{d\nu} = \frac{2(L'-L)}{c}$$

So, the number of modes per wavelength interval is

$$\left| \frac{dn}{d\lambda} \right| = \frac{dn}{d\nu} \left| \frac{d\nu}{d\lambda} \right| = \frac{2(L'-L)}{\lambda^2}$$

The total force from all the modes with wavelengths greater than $2L$ can be calculated as

$$K_{total} = \int_{2L}^{L'} K(\lambda) \frac{dn}{d\lambda} d\lambda$$

with the result

$$K_{total} = -\frac{hc}{8L^2} \left(1 - \frac{4L^2}{L'^2} \right)$$

It is seen that the total force is downwards (negative) when $L < L'/2$, and in the limit, when the external cut-off, L' goes to infinity we get the earlier quoted renormalized result

$$K_{total} = -\frac{hc}{8L^2}$$

Notes and references.

(danish references are marked with a (D)).

1. Roberto Poli, Foreword, *Axiomathes*, vol.12, p. 1-5, Kluwer, Dordrecht, 2001
 1. The New Elements of Mathematics by Charles S. Peirce vol. III, p. 112, ed. Carolyn Eisele, 1976.
2. Ken Wilber (ed.) the Holographic Paradigm and other Paradoxes interview with D. Bohm, ch. 5, Shambala Publications, Boston, 1982
3. This effect, predicted by the dutch physicist H.G.B. Casimir in 1948 was verified experimentally by M.J. Spaarnay in 1958.
4. Handbook of Mathematical Functions, ed. M. Abramowitz and I.A. Stegun, Dover, N.Y. 1965.
5. (D) See, e.g., the article by Michael Agermose Jensen in the journal of the Niels Bohr Institute, Copenhagen, *Gamma*, nr. 110 from june 1998.
6. (D) Jens Lyng Petersen: Elementarpartikler — om felter, kvarker og kvanter. Gyldendals Intro-serie, 1991.
7. (D) Peder Voetmann Christiansen, Fysik og semiotik — semiotikken i fysikken, *Anvendt semiotik*, red. Keld Gall Jørgensen, Gyldendal, 1997.
8. (D) Bent Sørensen: *Superstreng*—en teori om alt og intet. Munksgaard, Nysyn, 1987.
9. Edwina Taborsky: Energy and Evolutionary semiosis. Sign Systems Studies 30.1, University of Tartu, 2002.

Liste over tidligere udsendte tekster kan ses på IMFUFA's hjemmeside: <http://mmf.ruc.dk> eller rekvireres på sekretariatet, tlf. 46 74 22 63 eller e-mail: imfufa@ruc.dk.

- 332/97 ANOMAL SWELLING AF LIPIDE DOBBELTLAG
Specialrapport af: Sine Korremann
Vejleder: Dorte Posselt
- 333/97 Biodiversity Matters
an extension of methods found in the literature on monetisation of biodiversity
by: Bernd Kuemmel
- 334/97 LIFE-CYCLE ANALYSIS OF THE TOTAL DANISH ENERGY SYSTEM
by: Bernd Kuemmel and Bent Sørensen
- 335/97 Dynamics of Amorphous Solids and Viscous Liquids
by: Jeppe C. Dyre
- 336/97 Problem-orientated Group Project Work at Roskilde University
by: Kathrine Legge
- 337/97 Verdensbankens globale befolkningsprognose
- et projekt om matematisk modellering
af: Jørn Chr. Bendtsen, Kurt Jensen, Per Pauli Petersen
- 338/97 Kvantisering af nanolederes elektriske ledningsevne
Første modul fysikprojekt
af: Søren Dam, Esben Danielsen, Martin Niss,
Esben Friis Pedersen, Frederik Resen Steenstrup
Vejleder: Tage Christensen
- 339/97 Defining Discipline
by: Wolfgang Coy
- 340/97 Prime ends revisited - a geometric point of view -
by: Carsten Lunde Petersen
- 341/97 Two chapters on the teaching, learning and assessment of geometry
by: Mogens Niss
- 342/97 A global clean fossil scenario DISCUSSION PAPER prepared by Bernd Kuemmel
for the project LONG-TERM SCENARIOS FOR GLOBAL ENERGY DEMAND
AND SUPPLY
- 343/97 IMPORT/EKSPORT-POLITIK SOM REDSKAB TIL OPTIMERET UDNYTTELSE
AF EL PRODUCERET PÅ VE-ANLÆG
af: Peter Meibom, Torben Svendsen, Bent Sørensen

- 344/97 Puzzles and Siegel disks
by: Carsten Lunde-Petersen
- 345/98 Modeling the Arterial System with Reference to an Anesthesia Simulator
Ph.D. Thesis
by: Mette Sofie Olufsen
- 346/98 Klyngedannelse i en hukatode-forstøvningsproces
af: Sebastian Horst
Vejledere: Jørn Borggren, NBI, Niels Boye Olsen
- 347/98 Verificering af Matematiske Modeller
- en analyse af Den Danske Eulerske Model
af: Jonas Blomqvist, Tom Pedersen, Karen Timmermann, Lisbet Øhlenschläger
Vejleder: Bernhard Booss-Bavnbek
- 348/98 Case study of the environmental permission procedure and the environmental impact
assessment for power plants in Denmark
by: Stefan Krüger Nielsen
project leader: Bent Sørensen
- 349/98 Tre rapporter fra FAGMAT - et projekt om tal og faglig matematik i
arbejdsmarkeduddannelserne
af: Lena Lindenskov og Tine Wedege
- 350/98 OPGA VESAMLING - Breddes-kursus i Fysik 1976 - 1998
Erstatter teksterne 378, 261/93 og 322/96
- 351/98 Aspects of the Nature and State of Research in Mathematics Education
by: Mogens Niss
- 352/98 The Herman-Swiatec Theorem with applications
by: Carsten Lunde Petersen
- 353/98 Problemløsning og modellering i en almindelige matematikundervisning
Specialrapport af: Per Gregersen og Tomas Højgaard Jensen
- 354/98 A Global Renewable Energy Scenario
by: Bent Sørensen and Peter Meibom
- 355/98 Convergence of rational rays in parameter spaces
by: Carsten Lunde Petersen and Gustav Ryd

- 356/98 Terrænmodellering
Analyse af en matematisk model til konstruktion af digitale terrænmodeller
Modelprojekt af: Thomas Frommelt, Hans Ravnkjær Larsen og Arnold Skimminge
Vejleder: Johnny Ottesen
- 357/98 Cayleys Problem
En historisk analyse af arbejdet med Cayleys problem fra 1870 til 1918
Et matematisk videnskabsfagsprojekt af: Rikke Degn, Bo Jakobsen, Bjarke K.W.
Hansen, Jesper S. Hansen, Jesper Udesen, Peter C. Wulff
Vejleder: Jesper Larsen
- 358/98 Modeling of Feedback Mechanisms which Control the Heart Function in a View to an
Implementation in Cardiovascular Models
Ph.D. Thesis by: Michael Danielsen
-
- 359/99 Long-Term Scenarios for Global Energy Demand and Supply
Four Global Greenhouse Mitigation Scenarios
by: Bent Sørensen (with contribution from Bernd Kuemmel and Peter Meibom)
- 360/99 SYMMETRI I FYSIK
En Meta-projekt-rapport af: Martin Niss, Bo Jakobsen & Tune Bjarke Bonné
Vejleder: Peder Voetmann Christiansen
- 361/99 Symplectic Functional Analysis and Spectral Invariants
by: Bernhelm Booss-Bavnbek, Kenro Furutani
- 362/99 Er matematik en naturvidenskab? - en udspænding af diskussionen
En videnskabsfagsprojekt-rapport af: Martin Niss
Vejleder: Mogens Nørgaard Olesen
- 363/99 EMERGENCE AND DOWNWARD CAUSATION
by: Donald T. Campell, Mark H. Bickhard, and Peder V. Christiansen
- 364/99 Illustrationens kraft - Visuel formidling af fysik
Integreret speciale i fysik og kommunikation
af Sebastian Horst
Vejledere: Karin Beyer, Søren Kjørup
- 365/99 To know - or not to know - mathematics, that is a question of context
by: Tine Wedege
- 366/99 LATEX FOR FORFATTERE - En introduktion til LATEX
og IMFUFA-LATEX
af: Jørgen Larsen

- 367/99 Boundary Reduction of Spectral Invariants and Unique Continuation Property
by: Bernhelm Booss-Bavnbek
- 368/99 Kvartvejsrapport for projektet SCENARIER FOR SAMLET UDNYTTELSE AF
BRINT SOM ENERGIBÆRER I DANMARKS FREMTIDIGE ENERGISYSTEM
Projektleder: Bent Sørensen
- 369/99 Dynamics of Complex Quadratic Correspondences
by: Jacob S. Jalving
Supervisor: Carsten Lunde Petersen
- 370/99 OPGAVESAMLING - Bredde-Kursus i Fysik 1976 - 1999
Eksamensopgaver fra perioden 1976 - 1999. Denne tekst erstatter
tekst nr. 350/98
- 371/99 Bevisets stilling - beviser og bevisførelse i en gymnasial matematik
undervisning
Et matematikspeciale af: Maria Hermansson
Vejleder: Mogens Niss
- 372/99 En kontekstualiseret matematikhistorisk analyse af ikke-lineær programmering:
Udviklingshistorie og multipel opdagelse
Ph.d.-afhandling af Tinne Hoff Kjeldsen
- 373/99 Criss-Cross Reduction of the Maslov Index and a Proof of the Yoshida-Nicolaescu
Theorem
by: Bernhelm Booss-Bavnbek, Kenro Furutani and Nobukazu Otsuki
- 374/99 Det hydrauliske spring - Et eksperimentelt studie af polygoner og hastighedsprofiler
Specialeafhandling af: Anders Marcussen
Vejledere: Tomas Bohr, Clive Ellegaard, Bent C. Jørgensen
- 375/99 Begrundelser for Matematikundervisningen i den lærde skole hhv. gymnasiet 1884-
1914
Historiespeciale af Henrik Andreassen, cand.mag. i Historie og Matematik
- 376/99 Universality of AC conduction in disordered solids
by: Jeppe C. Dyre, Thomas B. Schrøder
- 377/99 The Kuhn-Tucker Theorem in Nonlinear Programming: A Multiple Discovery?
by: Tinne Hoff Kjeldsen
-
- 378/00 Solar energy preprints:
1. Renewable energy sources and thermal energy storage
2. Integration of photovoltaic cells into the global energy system
by: Bent Sørensen

- 379/00 EULERS DIFFERENTIALREGNING
Eulers indførelse af differentialregningen stillet over for den moderne
En tredjemesesters projektrapport på den naturvidenskabelige basisuddannelse
af: Uffe Thomas Volmer Jankvist, Rie Rose Møller Pedersen, Maja Bagge Pedersen
Vejleder: Jørgen Larsen
- 380/00 MATEMATISK MODELLELING AF HJERTEFUNKTIONEN
Isovolumetrisk ventrikulær kontraktion og udpumpning til det cardiovaskulære
system
af: Gitte Andersen (3. moduls-rapport), Jakob Hilmer og Stine Weisbjerg (speciale)
Vejleder: Johnny Ottesen
- 381/00 Matematikviden og teknologiske kompetencer hos kortuddannede voksne
- Rekognosceringer og konstruktioner i grænselandet mellem matematikkens didaktik
og forskning i voksenuddannelse
Ph. d.-afhandling af Tine Wedege
- 382/00 Den selvundvigende vandring
Et matematisk professionsprojekt
af: Martin Niss, Arnold Skimminge
Vejledere: Viggo Andreasen, John Villumsen
- 383/00 Beviser i matematik
af: Anne K.S.Jensen, Gitte M. Jensen, Jesper Thrane, Karen L.A.W. Wille, Peter
Wulff
Vejleder: Mogens Niss
- 384/00 Hopping in Disordered Media: A Model Glass Former and A Hopping Model
Ph.D. thesis by: Thomas B. Schrøder
Supervisor: Jeppe C. Dyré
- 385/00 The Geometry of Cauchy Data Spaces
This report is dedicated to the memory of Jean Leray (1906-1998)
by: B. Booss-Bavnbek, K. Furutani, K. P. Wojciechowski
- 386/00 Neutrale mandatfordelingsmetoder - en illusion?
af: Hans Henrik Brok-Kristensen, Knud Dyrberg, Tove Oxager, Jens Sveistrup
Vejleder: Bernhard Booss-Bavnbek
- 387/00 A History of the Minimax Theorem: von Neumann's Conception of the Minimax
Theorem - - a Journey Through Different Mathematical Contexts
by: Tinne Hoff Kjeldsen
- 388/00 Behandling af impuls ved kilder og dræn i C. S. Peskins 2D-hjertemodel
et 2. moduls matematik modelprojekt
af: Bo Jakobsen, Kristine Niss
Vejleder: Jesper Larsen
- 389/00 University mathematics based on problemoriented student projects: 25 years of
experience with the Roskilde model
By: Mogens Niss
Do not ask what mathematics can do for modelling. Ask what modelling can do for
mathematics!
by: Johnny Ottesen
- 390/01 SCENARIER FOR SAMLET UDNYTTTELSE AF BRINT SOM ENERGIBÆRER I
DANMARKS FREMTIDIGE ENERGISYSTEM Slutrapport, april 2001
Projektleder: Bent Sørensen
Projektdeltagere: DONG: Aksel Hauge Petersen, Celia Juhl, Elkraft System[®], Thomas
Engberg Pedersen[®], Hans Ravn, Charlotté Søndergren, Energi 2[®], Peter Simonsen,
RISØ Systemanalyseafd.: Kaj Jørgensen, Lars Henrik Nielsen, Helge V. Larsen,
Poul Erik Morthorst, Lotte Schleisner, RUC: Finn Sørensen[®], Bent Sørensen
[®]Indtil 1/1-2000 Elkraft, [®] fra 1/5-2000 Cowi Consult
[®]Indtil 15/6-1999 DTU Bygninger & Energi, [®] fra 1/1-2001 Polypeptide Labs.
Projekt 1763/99-0001 under Energistyrelsens Brintprogram
- 391/01 Matematisk modelleringskompetence - et undervisningsforløb i gymnasiet
3. semesters Nat.Bas. projekt af: Jess Tolstrup Boye, Morten Bjørn-Mortensen, Sofie
Inari Castella, Jan Lauridsen, Maria Gøtzsche, Ditte Mandøe Andreasen
Vejleder: Johnny Ottesen
- 392/01 "PHYSICS REVEALED" THE METHODS AND SUBJECT MATTER OF
PHYSICS
an introduction to pedestrians (but not excluding cyclists)
PART III: PHYSICS IN PHILOSOPHICAL CONTEXT
by: Bent Sørensen.
- 393/01 Hilberts matematikfilosofi
Specialerapport af: Jesper Hasmark Andersen
Vejleder: Stig Andur Pedersen
- 394/01 "PHYSICS REVEALED" THE METHODS AND SUBJECT MATTER OF
PHYSICS
an introduction to pedestrians (but not excluding cyclists)
PART II: PHYSICS PROPER
by: Bent Sørensen.
- 395/01 Menneskers forhold til matematik. Det har sine årsager!
Specialerapport af: Anita Stark, Agnete K. Ravnborg
Vejleder: Tine Wedege
- 396/01 2 bilag til tekst nr. 395: Menneskers forhold til matematik. Det har sine årsager!
Specialerapport af: Anita Stark, Agnete K. Ravnborg
Vejleder: Tine Wedege

- 397/01 En undersøgelse af solventens og kædelængdes betydning for anomal swelling i phospholipidbobbetlag
2. modul fysikrapport af: Kristine Niss, Arnold Skimminge, Esben Thormann, Stine Timmermann
Vejleder: Dorte Posselt
- 398/01 Kursusmateriale til "Lineære strukturer fra algebra og analyse" (E1)
Af: Mogens Bruun Heefelt
- 399/01 Undergraduate Learning Difficulties and Mathematical Reasoning
Ph.D Thesis by: Johan Liftner
Supervisor: Mogens Niss
- 400/01 On Holomorphic Critical quasi circle maps
By: Carsten Lunde Petersen
- 401/01 Finite Type Arithmetic
Computable Existence Analysed by Modified Realisability and Functional Interpretation
Master's Thesis by: Klaus Provin Jørgensen
Supervisors: Ulrich Kohlenbach, Stig Andur Pedersen and Anders Madsen
- 402/01 Matematisk modellering ved den naturvidenskabelige basisuddannelse
- udvikling af et kursus
Af: Morten Blomhøj, Tomas Højgaard Jensen, Tinne Hoff Kjeldsen og Johnny Ottesen
- 403/01 Generaliseringer i integralteorien
- En undersøgelse af Lebesgue-integralet, Radon-integralet og Perron-integralet
Et 2. modul matematikprojekt udarbejdet af: Stine Timmermann og Eva Uhre
Vejledere: Bernhelm Booss-Bavnbek og Tinne Hoff Kjeldsen
- 404/01 "Mere spredt fægting"
Af: Jens Højgaard Jensen
- 405/01 Real life routing
- en strategi for et virkeligt vrp
Et matematisk modelprojekt af: David Heiberg Backchi, Rasmus Brauner Godiksen, Uffe Thomas Volmer Jankvist, Jørgen Martin Poulsen og Neslihan Saglanmak
Vejleder: Jørgen Larsen
- 406/01 Opgavesamling til dybdekursus i fysik
Eksamenopgaver stillet i perioden juni 1976 til juni 2001
Denne tekst erstatter tekst nr. 25/1980 + efterfølgende tillæg
- 407/01 Unbounded Fredholm Operators and Spectral Flow
By: Bernhelm Booss-Bavnbek, Matthias Lesch, John Phillips

- 408/02 Weak UCP and Perturbed Monopole Equations
By: Bernhelm Booss-Bavnbek, Matilde Marcolli, Bai-Ling Wang
- 409/02 Algebraisk ligningsløsning fra Cardano til Cauchy
- et studie af kombinationers, permutations samt invariansbegrebets betydning for den algebraiske ligningsløsning, for Gauss, Abel og Galois
Videnskabsfagsprojekt af: David Heiberg Backchi, Uffe Thomas Volmer Jankvist, Neslihan Saglanmak
Vejleder: Bernhelm Booss-Bavnbek
- 410/02 2 projekter om modellering af influenzaepidemier
Influenzaepidemier- et matematisk modelleringsprojekt
Af: Claus Jørgensen, Christina Lohfert, Martin Mikkelsen, Anne-Louise H. Nielsen
Vejleder: Morten Blomhøj
Influenza A: Den tilbagevendende plage - et modelleringsprojekt
Af: Beth Paludan Carlsen, Christian Dahmcke, Lena Petersen, Michael Wagner
Vejleder: Morten Blomhøj
- 411/02 Polygonformede hydrauliske spring
Et modelleringsprojekt af: Kåre Stokvad Hansen, Ditte Jørgensen, Johan Rønby Pedersen, Bjørn Tolbod
Vejleder: Jesper Larsen
- 412/02 Hopfbifurkation og topologi i væskestrømning - en generel analyse samt en behandling af strømmingen bag en cylinder
Et matematisk modul III professionsprojekt af: Kristine Niss, Bo Jakobsen
Vejledere: Morten Brøns, Johnny Ottesen
- 413/03 "Elevernes stemmer" Fysikfaget, undervisningen og lærerroller, som eleverne opfatter det i det almene gymnasium i Danmark
Af: Carl Angell, Albert Chr. Paulsen
- 414/03 Feltiniediagrammer En vej til forståelse?
Et 1. modul fysikprojekt af: Ditte Gundermann, Kåre Stokvad Hansen, Ulf Rørbæk Pedersen
Vejleder: Tage Emil Christensen
- 415/03 FYSIKFAGET I FORANDRING Læring og undervisning i fysik i gymnasiet med fokus på dialogiske processer, autenticitet og kompetenceudvikling
Ph.d.-afhandling i fysikdidaktik af: Jens Dolin
- 416/03 Fourier og Funktionsbegrebet
- Overgangen fra Eulers til Dirichlets funktionsbegreb
Projektrapport af: Rasmus Brauner Godiksen, Claus Jørgensen, Tony Møyer Hanberg, Bjørn Tolbod
Vejleder: Erik von Essen

TEKST NR 419

2003

**Energy Bond Graphs—
—a semiotic formaliza-
tion of modern physics**

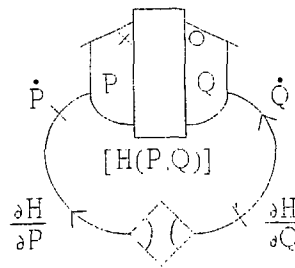

Peder Voetmann Christiansen

TEKSTER fra

IMFUFA

ROSKILDE UNIVERSITETSCENTER
INSTITUT FOR STUDIET AF MATEMATIK OG FYSIK SAMT DERES
FUNKTIONER I UNDERVISNING, FORSKNING OG ANVENDELSER

IMFUFA-Roskilde Universitetscenter- postbox 260-DK 4000 Roskilde

Tlf 46742263- Fax 46743020- Mail imfufa@ruc.dk

Peder Voetmann Christiansen

Energy Bond Graphs - A Semiotic Formalization of Modern Physics

Third International Gathering in Biosemiotics, Copenhagen 2003

IMFUFA tekst nr. 419-23 sider-ISBN 0106-6242

Abstract

This paper gives a brief introduction to the Energy Bond Graph (EBG) formalism - A modelling technique originally intended for Engineering and Ecological Energetics. The formalism is a shape-value notation built on C. S. Peirce's phenomenology and semiotics. Besides being a didactical tool for teaching physics to experienced students the formalism has proved valuable in connection with both the experimental and the theoretical physics research conducted at IMFUFA during the last 25 years.

The front page illustration shows the EBG formulation of Hamilton's equations.

Energy-bond-graphs — a semiotic formalization of modern physics.

by Peder Voetmann Christiansen
Roskilde University, Dept. of Mathematics and physics.
P.O. box 260, DK 4000 Roskilde, Denmark.
E-mail: pvc@ruc.dk.

Biosemiotics, 3. International Gathering, Copenhagen, July 12th 2003

1. Scope of the formalism

An Energy Bond Graph (EBG) is a comprehensive diagrammatic representation of all the relations that constitute a dynamical system. As such, it is a mathematical model, but not just mathematical. The EBG formalism requires a total reduction to physical standard relations that exist both as hardware and as software. It thus resembles a program or a wiring diagram for an analog computer representing both a set of equations and a construction-recipe for a real system that acts out the equations. EBG modelling is a "glass-bead-game" — a "fundamentalist" way of doing physics (proceeding from real fundamentals), like Peirce's Existential Graphs are to logic. Peirce said in his second Lowell Lecture from 1903 that he had spent forty years of his life developing the existential graphs and he described its purpose in the following way that may just as well serve as an introduction to the EBG-formalism:

"Before beginning, let us distinctly recognize the purpose which this system of expression is designed to fulfil. It is intended to enable us to separate reasoning into its smallest steps so that each one may be examined by itself. Observe, then, that it is *not* the purpose of this system of expression to facilitate reasoning and to enable one to reach his conclusion in the speediest manner. Were that our object, we should seek a system of expression which should reduce many steps to one; while our object is to subdivide one step into as many as possible. Our system is intended to facilitate the *study* of reasoning but not to facilitate reasoning itself. Its character is quite contrary to that purpose."

Contents

1. Scope of the formalism	p.1
2. Classification of dynamic variables	p. 2
3. Shape-value notations	p. 3
4. Basic response properties	p. 4
5. The energy bond, causality and orientation	p. 7
6. Definitions of basic icons	p. 9
7. Beyond laws of nature	p. 12
8. Completeness of the formalism	p. 16
9. Perspectives	p. 19
10. References	p. 21

The EBG-technique is not an easy way to mathematical models in physics, because it forces the user through an initial phase of semiotic reflections on categorization of variables, etc. This initial work, however, will lead to insights that are not easily gathered from more direct modelling techniques.

2. Classification of dynamic variables.

There are four kinds of dynamic variables in the EBG-formalism, and these are conveniently displayed in a Greimasian semiotic square. This method needs two pairs of binary opposites. The two members of a pair of opposites are placed diagonally against each other in the corners of a square, and then the four sides of the square identify the possibilities.

The two pairs of opposites are:

1: Level/rate, where the level-variables are accumulated, i.e. they can only change by time-integration of associated rates, whereas the rates may change abruptly.

2: directed (x)/undirected (o). Directed variables have direction both in space and time, i.e. they require a spatial orientation-convention and they change sign by time-reversal. Thus, we get the semiotic square of figure 1:

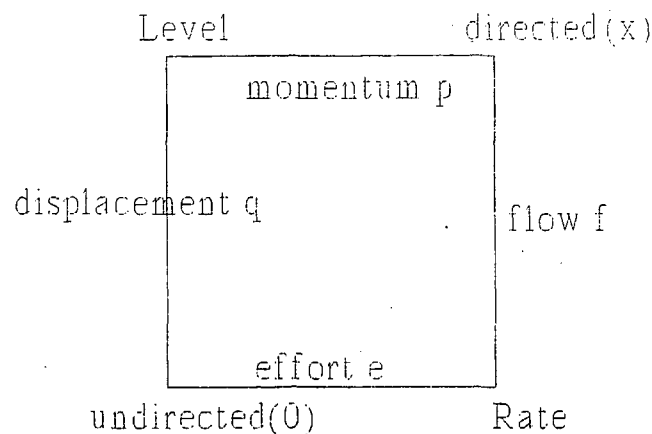

figure 1 Semiotic square of dynamic variables.

In EBG diagrams the levels are associated with "bird-house" storage icons (inspired by H.T. Odum)¹ marked x for kinetic energy and o for potential energy, while the rates are marked on the line-icon of an energy-bond with an arrow for the directed flow and a stroke for the undirected effort. The consideration that efforts (forces) are undirected reflects a deep law of classical mechanics, namely Newton's law of action and reaction.

Figure 2 below shows how the same system — a harmonic oscillator — is depicted by the present author (a) and with the more austere drawing style of the EBG-formalism's inventor H.M. Paynter (b).²

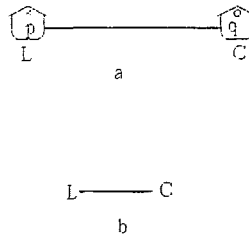

figure 2 Harmonic oscillator

3. Shape-value-notations

The difference between the two diagrams in figure 2 illustrates the concept of a *shape-value notation* (a) where the shape of the icons is chosen such as to convey an idea of their value or function and a *symbolic notation* where symbols like digits or letters are used to replace proper icons (b).

The present formulation was inspired by Odum's shape-value-notation for Ecological Energetics¹, but it was felt that the lack of physical precision in Odum's definitions of his icons could be remedied by using Paynter's bond-graphs². However, Paynter did not attempt to create suitable shapes for his icons and reverted to a symbolic notation, which lead to some ambiguities. By using, e.g., the letter T as an icon for a transformer/transducer one misses the fact that a proper definition of the

parameter of the object requires a distinction between its *primary* and its *secondary* port, and this distinction cannot be brought out by a symmetric shape like T, but only by an asymmetric icon (except in special cases), like the triangular shape in figure 6.

Some icons have associated parameters, denoted by symbols. The shape-value notation demands that the meaning of these symbols shall be uniquely defined by the shape of the icon. This demand means that it is sometimes necessary to have two different icons for the same physical function, as with the gyrators and the sinks shown in figure 6.

Attempts to create shape-value-notations for mathematics and logic have been studiously ignored by mathematicians, who for the last hundred years have preferred to continue in the trend laid out by Hilbert's shapeless axiomatization of Geometry. Thus was neglected Peirce's construction of a shape-value-notation for the sixteen binary logical connectives³ Peirce's notation was rediscovered by Shea Zellweger who has now developed it further to a complete "logic alphabet" thereby stressing the merits of shape-value notations for educational purposes⁴ Peirce's early version of his existential graphs (the alpha graphs) was also a shape-value notation of logic and a precursor of Spencer-Brown's "Laws of Form" from 1969.⁵

By developing the EBG-formalism as a shape-value notation the present author hopes to have helped strengthening an important historical strain that may prove valuable to Physics and Biosemiotics.

4. Basic response properties.

In a response experiment we act on a system through an energy bond, which, as we have seen, contain four variables, $q, f, e,$ and p . These four variables are not independent, because the levels q and p are time-integrals of the rates f and e . In the experiment we leave the system undisturbed from time $-\infty$ to time 0. Then we choose one of the four variables as *stimulus* s and let it have a constant value from time 0 to ∞ . As there are two causal groups of independent variables we can choose s from one group (e.g. (f, q)) and then observe the response $r(t)$ as one of the variables from the other group (e, p) . In the response-matrix shown in figure 2 there are thus two windows of possible response-properties, each containing four functions, but it can be shown that for *time-homogeneous*

systems where the result does not depend on which instant we choose as time 0, two of the four functions in each window will be identical. Any physical system therefore has six different response-properties.

	s				
r	q	f	e	p	
q			J	Y	
f			Y	F	
e	G	Z			
p	Z	M			

figure 3. the matrix of response-functions.

Response-semantics, i.e. the choice of proper nouns to denote the response-properties may then proceed from the *response-semiotics* of figure 3. In the following table we have combined usually used nouns with the six two-link Peircean sign classes: Read, e.g. (23) as "second of third".

- (11) G: *Rigidity* or *elastic modulus*.
- (12) Z: *Impedance* or *resistance*,
- (22) M: *Inertance* or *Inductance*.
- (13) F: *Lightness* or *Susceptibility*.
- (23) Y: *Conductance* or *Mobility*.
- (33) J: *Compliance* or *Capacitance*.

We have here defined the response-functions as functions of time from 0 to ∞ , but by Laplace-Stieltjes-transformations they are defined as functions of a complex frequency $s=-i\omega$. These complex functions are usually just called *generalized susceptibilities*.

However, there are many advantages in distinguishing the different functions by different names because they are mathematically related by time-integration: G integrates to Z, Z integrates to M, and similarly for the set F,Y,J. In the frequency- (s-) domain time integration corresponds to division by s. Thus, by this semiotic/semantic approach it becomes

possible to identify and name a response-property after a quick glance at the oscilloscope. And a careful distinguishing by names serves to develop the somewhat mysterious ability called "physical intuition".

5. the energy bond, causality and orientation.

the most basic icon of the EBG-formalism — *the energy bond* — is drawn as a simple line. It denotes an energetic *interaction* between two system-components. The interaction is mediated by the two rate-variables that belong to the bond: the directed *flow*, f , indexed as an arrow and the undirected *effort*, e , indexed as a stroke. If system A acts on system B with an effort, then system B acts back on system A with a flow. This causality is then indicated by placing the effort-index closest to B and the flow-index closest to A. By using an arrow as the flow-index we are forced to choose an *orientation* of the bond. Every bond may have either orientation, but when we want to view the same physical situation with the opposite orientation, we have to change the sign of the symbolic expression for the flow (f changes to $-f$). The interaction between A and B described above can thus be depicted in the two ways shown in figure 4:

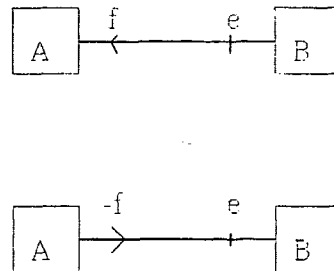

Figure 4 Interaction and orientation.

It must be stressed that the causality of an energy bond is not just a formal consideration made necessary by the algorithmic ordering. There

exists a precise measurement prescription to decide the causal order of the rate-variables for each bond, based on the analysis of transients or noise.

Every energetic interaction is associated with a flow of energy. The energy flow in the direction of the orientation of the bond is the product of effort and flow.

In general effort and flow are defined as *vectors in a complex metric space of arbitrary dimensionality*. The energy flow is then defined as the *scalar* product of the effort- and the flow-vector. This generalization, however leads to the complication that the vectors must be represented as either *covariant* or *contravariant*. The flow-orientation rule shown in figure 4 then has to be modified such that the change of orientation is associated with a shift of variance of both the effort- and the flow-vector. By adopting the further rule that *the same physical situation may be described with either variance of the effort* (but not of the flow), the formalism becomes able to treat vectors of mixed kinds where some of the effort-components are flows and the corresponding flow-components are efforts. This feature allows for a very general treatment of response-experiments, where, e.g. the celebrated *Onsager symmetry relations* becomes a theorem of the EBG-formalism.

The general vector-formulation also demands that *each bond is associated with a metric tensor* that relates the covariant to the contravariant vectors. A unit metrical tensor is represented as a matrix with 1s in the diagonal and 0s outside. This is *Euclidean metric*. When coordinate vectors are defined by three spatial coordinates and one time-coordinate the flow-vector's first three components will be flows and the fourth will be an effort. This corresponds to a metric tensor with 1s in the three first places of the diagonal and -1 in the fourth place — *the Minkowsky-metric*. The group of metric-preserving transformations for this metric are *the Lorentz-transformations*, and the whole formalism of special relativity follows from this. Likewise, by adopting the general tensor-formulation of *Riemannian metric spaces* the theory of general relativity also follows from the EBG-formalism.

6. Definitions of basic icons

EBG-modelling always proceeds through three semiotic stages: from *icons* through *indices* to *symbols*. Each icon denotes a basic physical relation between the input and output variables of the associated bonds (the *ports*). When indices — flow-arrows and effort-strokes are marked on the bonds, symbolic expressions for these variables are written near the indices, whereby the meaning of the symbols and the function of the icon is defined. Note that *nearness* is itself an indexical element inherent in the meaning of the symbols. Symbols near the icons are also used for defining certain parameters of the icons (like storage-capacity and transformer-ratio).

The basic icons are clearly divided in three classes corresponding to Peirce's three phenomenological categories:

- 1: *Active* systems (sources of flow or effort) have an output-variable that is independent of the input-variable.
- 2: *Passive* or *reactive* systems have an output that is determined by the present or the previous values of the input.
- 3: *Dissipative* systems (the sinks) mediate between active and passive behaviour. Their response is mainly passive, like the voltage over a resistor, given by Ohm's law, but the passive response is superposed with an active component — the *noise* — that depends both on the sink-parameter and the temperature.

In figure 5 we show definitions of the active and the reactive systems.

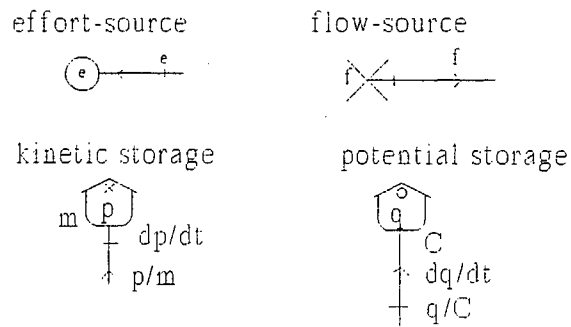

figure 5 active (sources) and reactive systems (storage)

Figure 6 shows the sinks and two passive 2-ports, transducer/transformer and gyrator. The definition does not distinguish between transducer and transformer, but the name "transducer" is used when the parameter t has a physical dimension, whereas transformers are dimensionless. Transformers and gyrators are very different although they look similar. The parameters t and g may be given as level-variables elsewhere in the system, but then t must be an undirected level, whereas g must be directed. Such *parametric feedback* is useful for modelling nonlinearities.

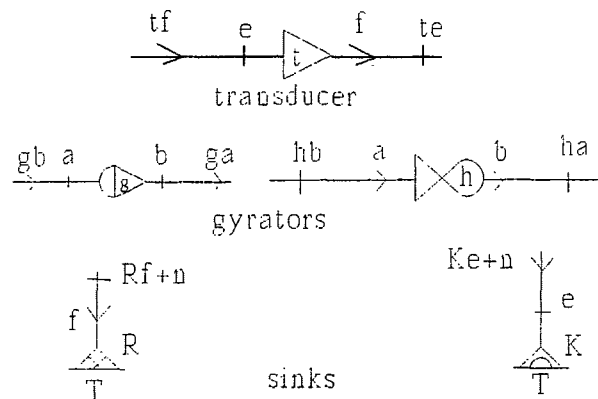

figure 6 Passive 2-ports and sinks (n denotes noise).

Finally, figure 7 shows the *junctions* as 3-ports, thus representing the only *triadic* relations of the formalism. The junctions are *topological* constraints corresponding to Kirchhoff's two laws of electrical networks. The o-junction corresponds to a node in the network (parallel connection) and the x-junction to a mesh (series connection). The similarities between o- and x-junction reflect the nearly dual symmetry between efforts and flows, but the dual symmetry is broken by the fact that flows are directed, while efforts are not, and this leads to subtle differences between the junctions, which, however, we shall not discuss here.

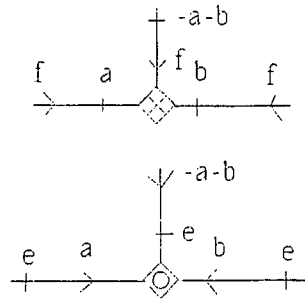

figure 7 The junctions.

7. Beyond laws of nature

A strange consequence of the EBG-game is that what we usually regard as laws of nature seem to vanish out of scope. Instead we have the rules of the game, which ensure that the laws of nature are obeyed. The vanishing of laws is thus a result of mathematization and semiotization. Similarly, in elementary physics the pupils learn the law of nature that forces are combined by the construction known as the parallelogram of forces, but in more advanced teaching they are just taught that forces are *vectors*, so the former law of nature becomes the rule for adding vectors.

We have seen that Newton's law of action and reaction hides within the rule that efforts are undirected or the flow-orientation rule of figure 4. Similarly, we can find Newton's second law of motion (force equals mass times acceleration) in the definition of the x-storage icon of figure 5, where m is the mass, p the momentum, e the force, and f the velocity (p/m). It was also mentioned that Onsager's symmetry- or reciprocity-relations is a theorem of the EBG-formalism. It is therefore not necessary for users of the formalism to know this as a law of nature, because it is automatically satisfied by all EBG-models that are made according to the rules.

Certain combinations of icons are not allowed, because they lead to *causal conflicts*. It is absolutely forbidden to connect two effort-sources directly or through a transformer. The sources are absolutely rigid in their causality, while other systems may be forced to yield. By connecting an effort source to a o-storage a mild conflict arises where the storage element is forced to give in and accept "differential causality". In this

way we are allowed to ascribe a conductivity to an electric, capacitor C , but the conflict still shows itself in the fact that the frequency-dependent conductivity Cs goes to infinity for large frequencies, which means that the causality will break down if the effort of the source changes very rapidly. Causal conflicts may often be resolved by introducing extra sinks. This happens, e.g. when a car tries to accelerate too fast; the wheels will slide on the road — a sink has appeared to represent the friction between wheel and road. In the traditional way of describing physical systems — by equations — there is no formal treatment of causality, so the concept of causal conflict does not exist, but in reality it plays an important role, especially when systems break down.

Many laws of nature are formulated as partial differential equations, e.g. the diffusion- and wave-equations, Maxwell's electromagnetic equations, and the Schrödinger equation. Such equations are in EBG diagrams shown by combining icons, each representing an infinitesimal section of space in structures that are repeated in three dimensional space like the atoms in a crystal. As an example of this figure 8 shows the unit cell for representing Maxwell's equations in vacuum. Not shown in the diagram are storage elements connected to the junctions: x-storage to x-junctions representing the magnetic induction-vector \underline{B} , and o-storage to o-junctions representing the electric displacement-vector \underline{D} . The electric field \underline{E} and the magnetic field \underline{H} are represented, respectively, as the efforts and the flows in the bonds.

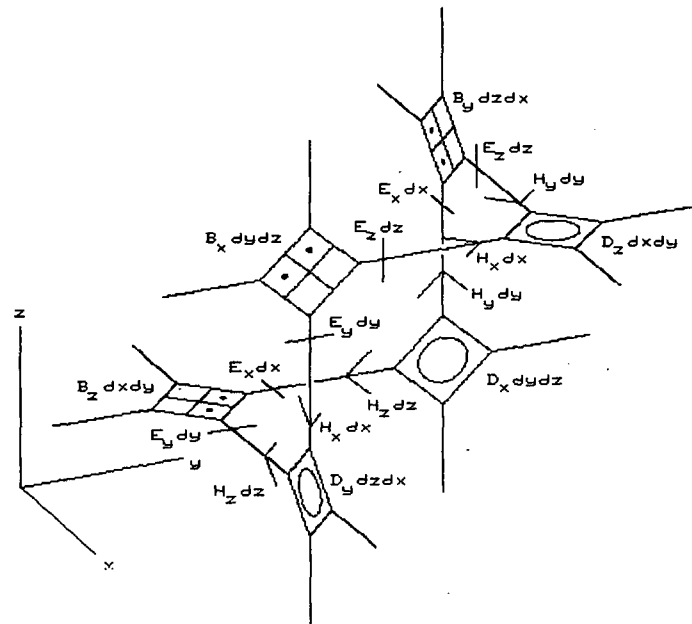
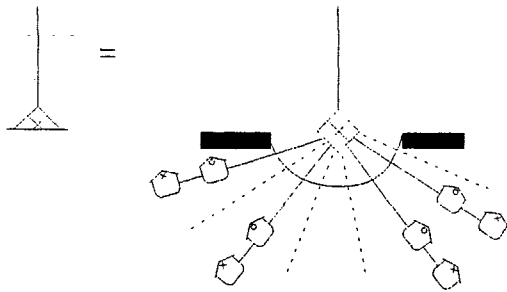

Figure 8 Unit cell for Maxwell's equations.

As mentioned, the sinks are sources of noise. This important insight follows from the *Fluctuation-Dissipation Theorem* by Callen and Welton (1951)⁶. As shown in figure 9 and the associated formula the complete complex impedance function $Z(\omega)$, ($\omega = is$) may be spectrally resolved on the response-functions of harmonic oscillators. The real, or dissipative part of the impedance $R(\omega')$ is proportional to the density of oscillators on the real axis of their resonance frequencies ω' . The spectral resolution formula is then valid when ω has a positive imaginary part. This formula is translated to icons in the figure and gives justification for the choice of the sink-icon. The noise is simply the output from all these uncorrelated oscillators in thermal equilibrium with the temperature T . For an ohmic resistance the oscillator-frequencies will be equally distributed over the real axis, and the noise-spectrum will be *white*.



$$Z(\omega) = \frac{i}{\pi} \int_0^{\infty} R(\omega') \left[\frac{1}{\omega - \omega'} + \frac{1}{\omega + \omega'} \right] d\omega'$$

figure 9 Spectral resolution of a sink

For a frequency-independent resistance R the prescription of the FD-theorem is simply that for each step dt of the numerical integration one has to add the effort-noise

$$n = N(\sqrt{(2RkT/dt)})$$

to the passive response of the sink. Here $N(x)$ is a normally distributed random number with mean value 0 and standard deviation x . k is Boltzmann's constant, and T the absolute temperature. The formula is valid in the *classical limit*, when $dt \gg \hbar/kT$.

It is noteworthy that the noise diverges to infinity when the steplength dt goes to zero. The noise is, as Peirce said,

"infinite in the here-and-nowness of immediate sensation, finite and relative in the recency of the past". (CP 6.135).

Every EBG-model containing dissipative elements thus becomes "animated with noise". It is easy to show that the level-variables of the system in this way get the exact fluctuation-moments that are prescribed by Statistical Mechanics, which in this way also becomes a result of the EBG-formalism.

The above expression for the effort-noise n demands that the sink-parameter R be positive. This is a further axiom of the formalism and it has the result that the energy flow to a sink, $R\dot{f}^2$ is always positive, thus ensuring that the laws of thermodynamics are always obeyed by EBG-models.

8. Completeness of the formalism

Within *Physics* and *Engineering* the EBG-formalism seems to be complete. Although new icons can be freely invented and added to the basic icons it seems always possible to make a full *reticulation*, i.e. to reduce these new functions to the basic icons. In practice it is easier to use a combination of basic and composite icons. The icons used by the author, shown in figure 10, are defined once and for all in an object-oriented drawing program (DrawPerfect 1.1)

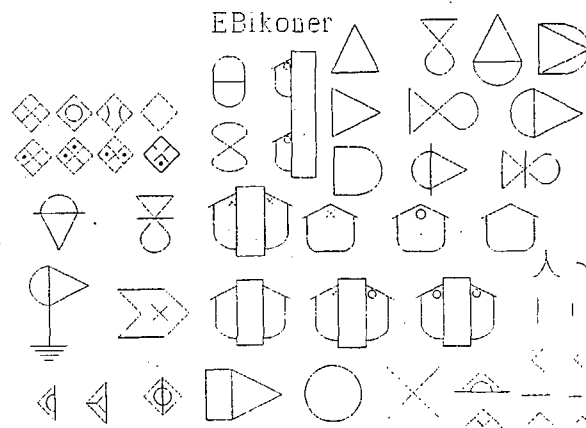

figure 10 Iconic objects of the EBG-formalism

A full proof of completeness is difficult to find (if not impossible), but many special cases have been considered⁷ and algorithmic prescriptions for their translation to the EBG language have been found, of which I shall just mention a few:

1 *Chemical reactions* forwards and backwards were first described by a reaction-icon based on H.T. Odum's *work-gate-icon*, but it was later shown that the reaction-icon can be reticulated by sinks and gyrators. In this way it is possible to make EBG-descriptions of large biochemical reaction-networks, like photosynthesis.

2 Topology of electrical and rheological networks are easily translated to EBG diagrams of junctions. It turns out, however, that the x-junction is a series connection in electricity but a parallel connection in rheology (and vice versa for the o-junction).

3 Linear response can be reduced to electrical networks⁸, and from there to EBG models. So in this case a full proof of completeness exists. On the other hand it is not always possible to translate EBG diagrams to electrical networks. (It may lead to short-circuits if one tries).

4 All systems that can be described with the Lagrangian and Hamiltonian methods of classical analytical mechanics can be translated to EBG-models by a relatively simple algorithm. So in this case the formalism is also proven complete, and it turns out that the EBG-models are generally more efficient for simulation than the Hamiltonian equations.

5 All relations exhibited by the basic icons are linear, but, as mentioned earlier, non-linearities may be introduced by parametric feedback from levels to transformers and gyrators. Such non-linearities will contain a time-delay, but many systems of classical mechanics require *simultaneous* non-linear relations. Such relations can also be given by an EBG diagram. In figure 11 it is shown how a simultaneous rendering of the relations $s=\sin\theta$ and $c=\cos\theta$ is reticulated:

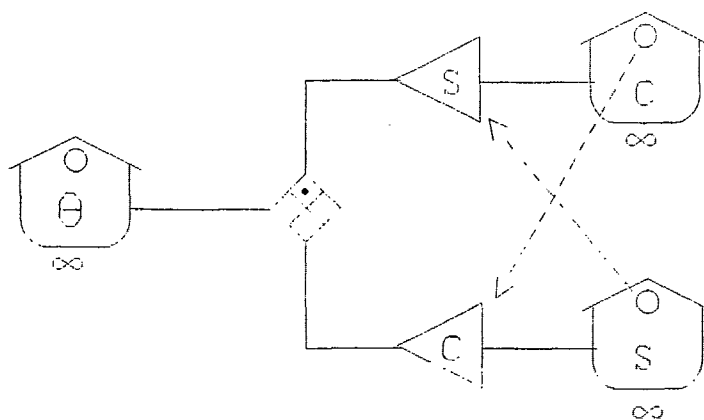

figure 11 Simultaneous reticulation of $c=\cos\theta$ and $s=\sin\theta$.

Finally, figure 12 shows how a complicated mechanical system — a double-pendulum — is fully reticulated with all its cosines and square-roots:

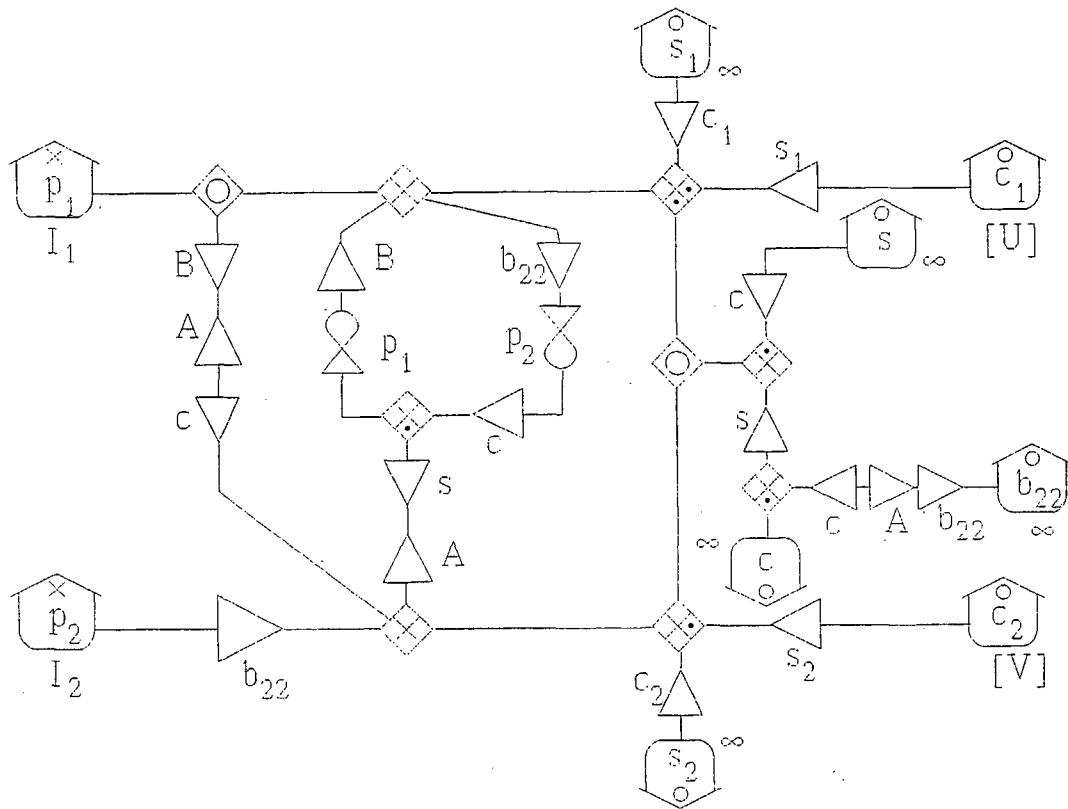

Figure 12 Full reticulation of double-pendulum.

9. Perspectives

Some biosemioticians are apprehensive about the dangers of physical reductionism. It must be admitted that EBG-formalism is an example of such reductionism, and even that it tries to carry physical reductionism to an extreme (by reducing basic physical concepts to even more basic semiotic concepts). Against such warnings I have several comments:

- 1): Kurt Gödel carried logical positivism to an extreme and found something on the other side of great importance to mathematics and philosophy.
- 2) An EBG-model is always open to expansion into the environment, except when the underlying theory demands a closure.
- 3) Regarding Biosemiotics: An EBG model is a sign of a general idea and thus, as Peirce said (CP 6.270) a living entity analogous to a person. The variables in an EBG-model are always superposed, both with thermal noise and quantum-fluctuations, that may be regarded as "living feeling" and spontaneity. If it is reductionistic to use such models in biology, it is, at least, not a simplistic kind of reductionism.
- 4) Regarding Quantum Mechanics: The EBG-formalism has a strong affinity to Quantum Mechanics, as it has to Relativity. If it becomes possible to construct an analog computer that can act out all the simultaneous feedbacks of EBG-models, it will be a quantum computer. The non-local constraints exhibited by the junctions give a simple explanation of Quantum-Non-Locality (the Einstein- Podolsky-Rosen experiments). Many other seemingly counter-intuitive quantum mechanical effects also appear as natural and understandable when viewed in the light of EBG-

reticulation of the physical sign-relations. A full investigation of this research program, called *Quantum Semiotic*, is in progress, but may take many years to complete.

Lejre, july 1. 2003

Peder Voetmann Christiansen.

10 References

1. H.T. Odum *Environment, Power, and Society*, Wiley, N.Y. 1972.
2. H.M. Paynter, *Analysis and Design of Engineering Systems*, M.I.T. Class notes, 1961.

D. Karnopp and R.C. Rosenberg, *Analysis and Simulation of Multiport Systems — The Bond Graph Approach to Physical System Dynamics*. The M.I.T. Press, Cambridge, Mass., 1968.
3. Louis H. Kauffman *The Mathematics of Charles Sanders Peirce, Cybernetics and Human Knowing*, vol. 8, No. 1-2, 2001
4. Shea Zellweger: *Mathelological Semiotics: A Lesson in constructing a Shape-Value Notation for Elementary Logic*. In: Myrdene Anderson et al. (ed.s) *Educational Perspectives on Mathematics As Semiosis: From Thinking To Interpreting To Knowing* Legas Publishing, Toronto, 2003.
5. G. Spencer-Brown: *Laws of Form*, George Allen & Unwin, Ltd. London 1969.
(See also the article by Jack Engstrom in ref. 3).
6. H.B. Callen and T.A. Welton. *Phys. Rev.* **83**, p. 208, (1951).
7. Peder Voetmann Christiansen *texts about the EBG-Formalism*, Tekster fra IMFUFA, Roskilde Universitetscenter (all in danish) The series includes texts no. 8 (1978), 22 (1979), 238 (1993), and 296 (1995). No. 22 discusses linear response and noise, no. 238 the vector and tensor formulation including relativity theory, and no. 296 Classical Analytical Mechanics.
8. M.E. van Valkenburg, *Introduction to Modern Network Synthesis*, Wiley, 1960.

Liste over tidligere udsendte tekster kan ses på IMFUFA's hjemmeside: <http://mmf.ruc.dk>
eller rekvireres på sekretariatet, tlf. 46 74 22 63 eller e-mail: imfufa@ruc.dk.

- 332/97 ANOMAL SWELLING AF LIPIDE DOBBELTLAG
Specialrapport af: Sine Korremann
Vejleder: Dorte Posselt
- 333/97 Biodiversity Matters
an extension of methods found in the literature on monetisation of biodiversity
by: Bernd Kuemmel
- 334/97 LIFE-CYCLE ANALYSIS OF THE TOTAL DANISH ENERGY SYSTEM
by: Bernd Kuemmel and Bent Sørensen
- 335/97 Dynamics of Amorphous Solids and Viscous Liquids
by: Jeppe C. Dyre
- 336/97 Problem-orientated Group Project Work at Roskilde University
by: Kathrine Legge
- 337/97 Verdensbankens globale befolkningsprognose
- et projekt om matematisk modellering
af: Jørn Chr. Bendtsen, Kurt Jensen, Per Pauli Petersen
- 338/97 Kvantisering af nanolederes elektriske ledningsevne
Første modul fysikprojekt
af: Søren Dam, Esben Danielsen, Martin Niss,
Esben Friis Pedersen, Frederik Resen Steenstrup
Vejleder: Tage Christensen
- 339/97 Defining Discipline
by: Wolfgang Coy
- 340/97 Prime ends revisited - a geometric point of view -
by: Carsten Lunde Petersen
- 341/97 Two chapters on the teaching, learning and assessment of geometry
by: Mogens Niss
- 342/97 A global clean fossil scenario DISCUSSION PAPER prepared by Bernd Kuemmel
for the project LONG-TERM SCENARIOS FOR GLOBAL ENERGY DEMAND
AND SUPPLY
- 343/97 IMPORT/EKSPORT-POLITIK SOM REDSKAB TIL OPTIMERET UDNYTTELSE
AF EL PRODUCERET PÅ VE-ANLÆG
af: Peter Meibom, Torben Svendsen, Bent Sørensen

- 344/97 Puzzles and Siegel disks
by: Carsten Lunde-Petersen
- 345/98 Modeling the Arterial System with Reference to an Anesthesia Simulator
Ph.D. Thesis
by: Mette Sofie Olufsen
- 346/98 Klyngedannelse i en hukatode-forstøvningsproces
af: Sebastian Horst
Vejledere: Jørn Borggren, NBI, Niels Boye Olsen
- 347/98 Verificering af Matematiske Modeller
- en analyse af Den Danske Eulerske Model
af: Jonas Blomqvist, Tom Pedersen, Karen Timmermann, Lisbet Øhlenschläger
Vejleder: Bernhard Booss-Bavnbek
- 348/98 Case study of the environmental permission procedure and the environmental impact
assessment for power plants in Denmark
by: Stefan Krüger Nielsen
project leader: Bent Sørensen
- 349/98 Tre rapporter fra FAGMAT - et projekt om tal og faglig matematik i
arbejdsmarkeduddannelserne
af: Lena Lindenskov og Tine Wedege
- 350/98 OPGA VESAMLING - Bredde-Kursus i Fysik 1976 - 1998
Erstatter teksterne 3/78, 261/93 og 322/96
- 351/98 Aspects of the Nature and State of Research in Mathematics Education
by: Mogens Niss
- 352/98 The Herman-Swiatec Theorem with applications
by: Carsten Lunde Petersen
- 353/98 Problemløsning og modellering i en almindende matematikundervisning
Specialrapport af: Per Gregersen og Tomas Højgaard Jensen
- 354/98 A Global Renewable Energy Scenario
by: Bent Sørensen and Peter Meibom
- 355/98 Convergence of rational rays in parameter spaces
by: Carsten Lunde Petersen and Gustav Ryd

356/98 Terrænmodellering
Analyse af en matematisk model til konstruktion af digitale terrænmodeller
Modelprojekt af: Thomas Frommelt, Hans Ravnkjær Larsen og Arnold Skimminge
Vejleder: Johnny Ottesen

357/98 Cayleys Problem
En historisk analyse af arbejdet med Cayleys problem fra 1870 til 1918
Et matematisk videnskabsfagsprojekt af: Rikke Degn, Bo Jakobsen, Bjarke K. W.
Hansen, Jesper S. Hansen, Jesper Udesen, Peter C. Wuiff
Vejleder: Jesper Larsen

358/98 Modeling of Feedback Mechanisms which Control the Heart Function in a View to an
Implementation in Cardiovascular Models
Ph.D. Thesis by: Michael Danielsen

359/99 Long-Term Scenarios for Global Energy Demand and Supply
Four Global Greenhouse Mitigation Scenarios
by: Bent Sørensen (with contribution from Bernd Kuemmel and Peter Meibom)

360/99 SYMMETRI I FYSIK
En Meta-projektrapport af: Martin Niss, Bo Jakobsen & Tune Bjarke Bonné
Vejleder: Peder Voetmann Christiansen

361/99 Symplectic Functional Analysis and Spectral Invariants
by: Bernhard Boos-Bavnbek, Kenro Furutani

362/99 Er matematik en naturvidenskab? - en udspænding af diskussionen
En videnskabsfagsprojekt-rapport af: Martin Niss
Vejleder: Mogens Nørgaard Olesen

363/99 EMERGENCE AND DOWNWARD CAUSATION
by: Donald T. Campbell, Mark H. Bickhard, and Peder V. Christiansen

364/99 Illustrationens kraft - Visuel formidling af fysik
Integreret speciale i fysik og kommunikation
af Sebastian Horst
Vejledere: Karin Beyer, Søren Kjørup

365/99 To know - or not to know - mathematics, that is a question of context
by: Tine Wedege

366/99 LATEX FOR FORFATTERE - En introduktion til LATEX
og IMFUFA-LATEX
af: Jørgen Larsen

367/99 Boundary Reduction of Spectral Invariants and Unique Continuation Property
by: Bernhard Boos-Bavnbek

368/99 Kvartvejsrapport for projektet SCENARIER FOR SAMLET UDNYTTELSE AF
BRINT SOM ENERGIBÆRER I DANMARKS FREMTIDIGE ENERGISYSTEM
Projektleder: Bent Sørensen

369/99 Dynamics of Complex Quadratic Correspondences
by: Jacob S. Jalving
Supervisor: Carsten Launde Petersen

370/99 OPGAVESAMLING - Bredde-Kursus i Fysik 1976 - 1999
Eksamensopgaver fra perioden 1976 - 1999. Denne tekst erstatter
tekst nr. 350/98

371/99 Bevisets stilling - beviser og bevisførelse i en gymnasial matematik
undervisning
Et matematikspeciale af: Maria Hermannsson
Vejleder: Mogens Niss

372/99 En kontekstualiseret matematikhistorisk analyse af ikke-lineær programmering:
Udviklingshistorie og multipel opdagelse
Ph.d.-afhandling af Tinne Hoff Kjeldsen

373/99 Criss-Cross Reduction of the Maslov Index and a Proof of the Yoshida-Nicolaescu
Theorem
by: Bernhard Boos-Bavnbek, Kenro Furutani and Nobukazu Otsuki

374/99 Det hydrauliske spring - Et eksperimentelt studie af polygoner og hastighedsprofiler
Specialeafhandling af: Anders Marcussen
Vejledere: Tomas Bohr, Clive Ellegaard, Bent C. Jørgensen

375/99 Begrundelser for Matematikundervisningen i den lærde skole hhv. gymnasiet 1884-
1914
Historiespeciale af Henrik Andreassen, cand.mag. i Historie og Matematik

376/99 Universality of AC conduction in disordered solids
by: Jeppe C. Dyre, Thomas B. Schrøder

377/99 The Kuhn-Tucker Theorem in Nonlinear Programming: A Multiple Discovery?
by: Tinne Hoff Kjeldsen

378/00 Solar energy preprints:
1. Renewable energy sources and thermal energy storage
2. Integration of photovoltaic cells into the global energy system
by: Bent Sørensen

- 389/00 University mathematics based on problemoriented student projects: 25 years of experience with the Roskilde model
By: Mogens Niss
Do not ask what mathematics can do for modelling. Ask what modelling can do for mathematics!
Vejleder: Johnny Ottesen
-
- 390/01 SCENARIER FOR SAMLET UDNYTTELSE AF BRINT SOM ENERGIBÆRER I DANMARKS FREMTIDIGE ENERGISYSTEM Slutrapport, april 2001
Projektleder: Bent Sørensen
Projektdeltagere: DONG: Aksel Hauge Petersen, Celia Juhl, Elkraft System[®]; Thomas Engberg Pedersen[®]; Hans Ravn, Charlotte Søndergen, Energi 2[®]; Peter Simonsen, RISØ Systemanalyseafd.: Kaj Jørgensen[®], Lars Henrik Nielsen, Helge V. Larsen, Poul Erik Morthorst, Lotte Schleisner, RUC: Finn Sørensen[®], Bent Sørensen[®]
[®]Indtil 1/1-2000 Elkraft, [®]fra 1/5-2000 Cowi Consult
[®]Indtil 15/6-1999 DTU Bygninger & Energi, [®]fra 1/1-2001 Polypeptide Labs.
Projekt 1763/99-0001 under Energistyrelsens Brintprogram
- 391/01 Matematisk modelleringskompetence – et undervisningsforløb i gymnasiet 3. semesters Nat.Bas. projekt af: Jess Tolstrup Boye, Morten Bjørn-Mortensen, Sofie Inari Castella, Jan Lauridsen, Maria Grätzsche, Ditte Mandøe Andreassen
Vejleder: Johnny Ottesen
- 392/01 "PHYSICS REVEALED" THE METHODS AND SUBJECT MATTER OF PHYSICS
an introduction to pedestrians (but not excluding cyclists)
PART III: PHYSICS IN PHILOSOPHICAL CONTEXT
by: Bent Sørensen.
- 393/01 Hilberts matematikfilosofi
Specialrapport af: Jesper Hasmark Andersen
Vejleder: Stig Andur Pedersen
- 394/01 "PHYSICS REVEALED" THE METHODS AND SUBJECT MATTER OF PHYSICS
an introduction to pedestrians (but not excluding cyclists)
PART II: PHYSICS PROPER
by: Bent Sørensen.
- 395/01 Menneskers forhold til matematik. Det har sine årsager!
Specialeafhandling af: Anita Stark, Agnete K. Ravnborg
Vejleder: Tine Wedge
- 396/01 2 bilag til tekst nr. 395: Menneskers forhold til matematik. Det har sine årsager!
Specialeafhandling af: Anita Stark, Agnete K. Ravnborg
Vejleder: Tine Wedge

- 379/00 EULERS DIFFERENTIALREGNING
Eulers indførelse af differentialregningen stillet over for den moderne
En tredjeesters projektrapport på den naturvidenskabelige basisuddannelse
af: Uffe Thomas Volmer Jankvist, Rie Rose Møller Pedersen, Maja Bagge Pedersen
Vejleder: Jørgen Larsen
- 380/00 MATEMATISK MODELLERING AF HJERTEFUNKTIONEN
Isovolumetrisk ventrikulær kontraktion og udpumpning til det cardiovaskulære system
af: Gitte Andersen (3. moduls-rapport), Jakob Hilmer og Stine Weisbjerg (speciale)
Vejleder: Johnny Ottesen
- 381/00 Matematikviden og teknologiske kompetencer hos kortuddannede voksne
- Rekognosceringer og konstruktioner i grænselandet mellem matematikkens didaktik og forskning i voksenuddannelse
Ph. d.-afhandling af Tine Wedge
- 382/00 Den selvundvigende vandring
Et matematisk professionsprojekt
af: Martin Niss, Arnold Skimminge
Vejledere: Viggo Andreassen, John Villumsen
- 383/00 Beviser i matematik
af: Anne K.S.Jensen, Gitte M. Jensen, Jesper Thrane, Karen L.A.W. Wille, Peter Wulff
Vejleder: Mogens Niss
- 384/00 Hopping in Disordered Media: A Model Glass Former and A Hopping Model
Ph.D. thesis by: Thomas B. Schrøder
Supervisor: Jeppe C. Dyre
- 385/00 The Geometry of Cauchy Data Spaces
This report is dedicated to the memory of Jean Leray (1906-1998)
by: B. Booss-Bavnbek, K. Furutani, K. P. Wojciechowski
- 386/00 Neutrale mandatfordelingsmetoder – en illusion?
af: Hans Henrik Brok-Kristensen, Knud Dyrberg, Tove Oxager, Jens Sveistrup
Vejleder: Bernhard Booss-Bavnbek
- 387/00 A History of the Minimax Theorem: von Neumann's Conception of the Minimax Theorem - - a Journey Through Different Mathematical Contexts
by: Tinne Hoff Kjeldsen
- 388/00 Behandling af impuls ved kilder og dræn i C. S. Peskins 2D-hjertemodel
et 2. moduls matematik modelprojekt
af: Bo Jakobsen, Kristine Niss
Vejleder: Jesper Larsen

397/01 En undersøgelse af solvents og kædelængdes betydning for anomalous swelling i phospholipidbobbeltåg
2. modul fysikrapport af: Kristine Niss, Arnold Skimminge, Esben Thormann, Stine Timmermann
Vejleder: Dorthe Posselt

398/01 Kursusmateriale til "Lineære strukturer fra algebra og analyse" (E1)
Af: Mogens Bruun Heefelt

399/01 Undergraduate Learning Difficulties and Mathematical Reasoning
Ph.D Thesis by: Johan Lithner
Supervisor: Mogens Niss

400/01 On Holomorphic Critical quasi circle maps
By: Carsten Lunde Petersen

401/01 Finite Type Arithmetic
Computable Existence Analysed by Modified Realisability and Functional Interpretation
Master's Thesis by: Klaus Frovin Jørgensen
Supervisors: Ulrich Kohlenbach, Stig Andur Pedersen and Anders Madsen

402/01 Matematisk modellering ved den naturvidenskabelige basisuddannelse
- udvikling af et kursus
Af: Morten Blomhøj, Tomas Højgaard Jensen, Tinne Hoff Kjeldsen og Johnny Ottesen

403/01 Generaliseringer i integralteorien
- En undersøgelse af Lebesgue-integralet, Radon-integralet og Perron-integralet
Et 2. modul matematikprojekt udarbejdet af: Stine Timmermann og Eva Uhre
Vejledere: Bernhelm Booss-Bavnbek og Tinne Hoff Kjeldsen

404/01 "Mere spredt fægning"
Af: Jens Højgaard Jensen

405/01 Real life routing
- en strategi for et virkeligt vrp
Et matematisk modelprojekt af: David Heiberg Backchi, Rasmus Brauner Godiksen, Uffe Thomas Volmer Jankvist, Jørgen Martin Poulsen og Neslihan Saglanmak
Vejleder: Jørgen Larsen

406/01 Opgavesamling til dybdekursus i fysik
Eksamensopgaver stillet i perioden juni 1976 til juni 2001
Denne tekst erstatter tekst nr. 25/1980 + efterfølgende tillæg

407/01 Unbounded Fredholm Operators and Spectral Flow
By: Bernhelm Booss-Bavnbek, Matthias Lesch, John Phillips

408/02 Weak UCP and Perturbed Monopole Equations
By: Bernhelm Booss-Bavnbek, Matilde Marcolli, Bai-Ling Wang

409/02 Algebraisk ligningsløsning fra Cardano til Cauchy
- et studie af kombinationer, permutationer samt invariansbegrebets betydning for den algebraiske ligningsløsning /for Gauss, Abel og Galois
Videnskabsfagsprojekt af: David Heiberg Backchi, Uffe Thomas Volmer Jankvist, Neslihan Saglanmak
Vejleder: Bernhelm Booss-Bavnbek

410/02 2 projekter om modellering af influenzaepidemier
Influenzaepidemier- et matematisk modelleringsprojekt
Af: Claus Jørgensen, Christina Lohfert, Martin Mikkelsen, Anne-Louise H. Nielsen
Vejleder: Morten Blomhøj
Influenza A: Den tilbagevendende plage – et modelleringsprojekt
Af: Beth Paludan Carlsen, Christian Dahmeke, Lena Petersen, Michael Wagner
Vejleder: Morten Blomhøj

411/02 Polygonformede hydrauliske spring
Et modelleringsprojekt af: Kåre Stokvad Hansen, Ditte Jørgensen, Johan Rønby Pedersen, Bjørn Tolbod
Vejleder: Jesper Larsen

412/02 Hopfbifurkation og topologi i væskestrømning – en generel analyse samt en behandling af strømmingen bag en cylinder
Et matematisk modul III professionsprojekt af: Kristine Niss, Bo Jakobsen
Vejledere: Morten Brøns, Johnny Ottesen

413/03 "Elevernes stemmer" Fysikfaget, undervisningen og lærerroller, som eleverne opfatter det i det almene gymnasium i Danmark
Af: Carl Angell, Albert Chr. Paulsen

414/03 Feltiniediagrammer En vej til forståelse?
Et 1. modul fysikprojekt af: Ditte Gundermann, Kåre Stokvad Hansen, Ulf Rørbæk Pedersen
Vejleder: Tage Emil Christensen

415/03 FYSIKFAGET I FORANDRING Læring og undervisning i fysik i gymnasiet med fokus på dialogiske processer, autenticitet og kompetenceudvikling
Ph.d.-afhandling i fysikdidaktik af: Jens Dolin

416/03 Fourier og Funktionsbegrebet
- Overgangen fra Eulers til Dirichlets funktionsbegreb
Projekt rapport af: Rasmus Brauner Godiksen, Claus Jørgensen, Tony Moyer Hanberg, Bjørn Tolbod
Vejleder: Erik von Essen

417/03

The Semiotic Flora of Elementary particles
By: Peder Voetmann Christiansen

418/03

Militærmatematik set med kompetencebriller
3. modul projektrapport af: Gitte Jensen og specialrapport af: Jesper Thrane
Vejleder: Tine Wedege